

# COMPREHENSIVE GUIDE

SIGN PRODUCTS & PRICING



GEMINI

*Made True.*



# PRODUCT AND PRICE GUIDES TO MEET YOUR NEEDS

Discover what's new about our catalogs

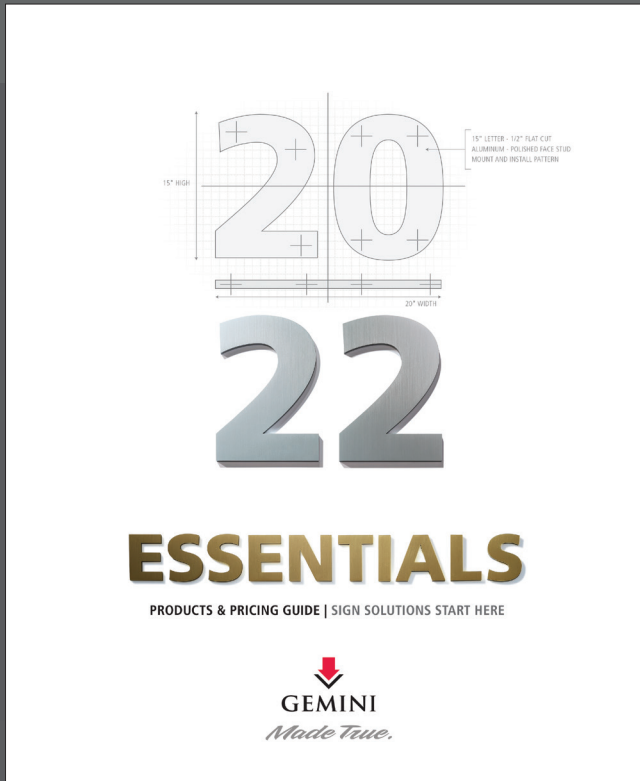

## ◀ SIGN SOLUTIONS START HERE

The Gemini ESSENTIALS Catalog you are holding (or viewing online) highlights the products and options that represent over 90% of what our customers order. Here's why that matters:

- Get to the products you use most frequently, faster
- Access the most specified products, used by thousands of your peers in the industry
- ALL products and options in the ESSENTIALS catalog will be included in our new TrueQuote portal (coming in 2022), so if it's in here, you can generate a quote online 24/7 that we stand behind 100%

## EXPLORE THE POSSIBILITIES ▶

Our full catalog selection is available online. So if you need something special, you'll find it in our digital catalog—Gemini's COMPREHENSIVE GUIDE to Sign Products and Pricing. It's where you can explore our complete offering, options and pricing, with dozens of additional pages and resources.

Find it in the Partner Portal at  
[GeminiSignage.com](https://www.geminisignage.com)

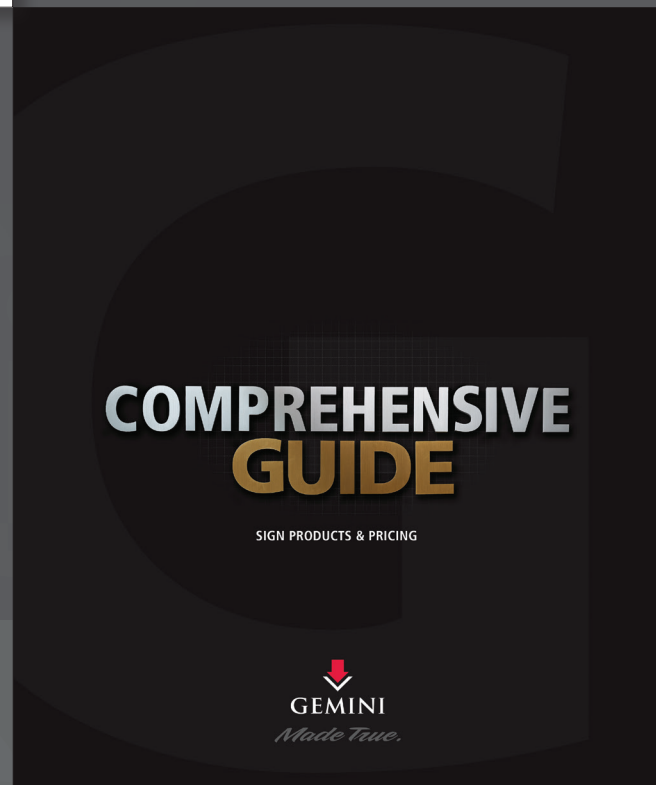



## A PROMISE TO OUR CUSTOMERS

Gemini is committed to supplying you with the world's highest quality dimensional letters, logos and plaques at fair prices, with the fastest delivery, all with a Lifetime Guarantee. If for any reason you have a problem with anything we make or do, we will make it right with you.

DEAR FELLOW SIGN, DESIGN AND RECOGNITION PROFESSIONALS,

LAST YEAR ENDED STRONG FOR THE SIGN INDUSTRY AND WE THANK ALL OF YOU FOR KEEPING OUR LIGHTS ON AT GEMINI DURING A DIFFICULT TIME. 2022 WILL BRING DIFFERENT CHALLENGES WITH SHORTAGES IN MATERIALS AND LABOR FURTHER IMPACTING OUR ECONOMY. IN THE US, WE ARE EXPERIENCING GREATER INFLATION THAN WE CAN RECALL IN OUR COMPANY'S HISTORY – AND I KNOW THAT YOU ARE SEEING MANY OF THE SAME PRESSURES IN YOUR BUSINESS.

TO COMBAT SOME OF THESE PRESSURES WE HAVE CONTINUED TO INNOVATE TO PROVIDE YOU WITH EVEN BETTER SERVICE AND QUALITY OF PRODUCTS. OVER THE NEXT YEAR, YOU CAN EXPECT US TO REGAIN EVEN FASTER LEAD TIMES ON BOTH QUOTES AND ORDERS THAN PRE-PANDEMIC; AND AT THE SAME TIME WE WILL BE ROLLING OUT ADVANCED DIGITAL TOOLS AND RESOURCES THAT MAKE IT EASIER THAN EVER FOR YOU TO EXPLORE, QUOTE, AND ORDER GEMINI PRODUCTS.

OUR COMPANY MISSION STATES THAT GEMINI WILL IDENTIFY WHAT MATTERS; AND TO BE THE MOST CONVENIENT SUPPLIER OF IDENTIFICATION PRODUCTS AVAILABLE. AFTER LISTENING TO YOUR FEEDBACK OVER THE PAST YEAR – WE'VE PUT PLANS IN PLACE TO SIMPLIFY AND STREAMLINE OUR PROCESSES. OUR CATALOG HAS GROWN FROM AN 8-PAGE FORMED LETTER FLYER IN 1963 TO THREE TITLES IN 2020 THAT TOTAL OVER 300 PAGES. THIS YEAR, WE HAVE RECOMBINED OUR MAIN TITLE CATALOG AND INCLUDED ONLY THE "ESSENTIALS" IN THIS PRICE GUIDE THAT CONTAINS THOSE OPTIONS WHICH COMPRISE WELL OVER 90% OF OUR VOLUME.

WE HAVE ALSO SIMPLIFIED SOME OF OUR PRICING TO HAVE FEWER "ADD" CHARGES FOR A MAJORITY OF OUR PRODUCTS. THIS PARED DOWN AND SIMPLIFIED VIEW OF GEMINI'S PRODUCTS WILL HELP YOU QUICKLY FIND THE BEST SOLUTION FOR THE VAST MAJORITY OF YOUR SIGNAGE APPLICATIONS. THAT BEING SAID, WE HAVE NOT CUT BACK ON OUR OFFERINGS – BUT SIMPLY HIGHLIGHTED THESE MOST COMMONLY-USED ELEMENTS IN PRINT TO WORK IN CONJUNCTION WITH AN UPDATED, COMPREHENSIVE DIGITAL QUOTING TOOL "TRUEQUOTE" AVAILABLE ON OUR DIGITAL PARTNER PORTAL. IF YOU ARE LOOKING FOR SOME OF THOSE UNIQUE SPECIALTY FINISHES, MOUNTINGS, OR OBSCURE SIGNAGE PRODUCTS – AN EXHAUSTIVE RESOURCE IS AVAILABLE ONLINE THAT INCLUDES HUNDREDS OF PAGES OF ADDITIONAL MATERIAL IN GEMINI'S COMPREHENSIVE GUIDE DIGITAL CATALOG THAT ROUNDS OUT OUR PRODUCT PORTFOLIO.

IF OUR PRINTED CATALOG OR DIGITAL RESOURCES STILL AREN'T GIVING YOU THE INFORMATION YOU NEED – WE'RE ALWAYS HERE TO HELP YOU THROUGH EMAIL, CHAT, OR ON THE PHONE.

THANK YOU FOR YOUR CONTINUED BUSINESS. FROM OUR FAMILY TO YOURS, WE ARE HONORED TO HAVE EARNED YOUR BUSINESS OVER THE YEARS, AND I HOPE WE'VE EARNED YOUR LOYALTY AS WELL. WE DON'T SELL DIRECT TO YOUR CUSTOMERS, SO YOUR SUCCESS IS OUR SUCCESS. WE LOOK FORWARD TO PARTNERING WITH YOU DURING THE YEAR AHEAD.

SINCERELY,

Frederick M. Oss, President





#### GEMINI INCORPORATED

103 Mensing Way  
Cannon Falls, MN 55009-1143 USA  
[www.GeminiSignage.com](http://www.GeminiSignage.com)

#### USA LETTERS & LOGOS

**1-800-538-8377**

[Signage@GeminiMade.com](mailto:Signage@GeminiMade.com)

Monday–Friday: 7 a.m.–7 p.m.  
Saturday: 8 a.m.–noon (Central)

#### USA PLAQUES

**1-877-877-2922**

[Plaques@GeminiMade.com](mailto:Plaques@GeminiMade.com)

Monday–Friday: 7 a.m.–7 p.m.  
Saturday: 8 a.m.–noon (Central)

#### CANADA LETTERS, LOGOS & PLAQUES

**1-800-265-0426**

[Canada@GeminiMade.com](mailto:Canada@GeminiMade.com)

Monday–Friday: 7 a.m.–8 p.m.  
Saturday: 9 a.m.–1 p.m. (Eastern)

#### INTERNATIONAL

**1-507-263-3957**

[Signage@GeminiMade.com](mailto:Signage@GeminiMade.com)

Monday–Friday: 7 a.m.–7 p.m.  
Saturday: 8 a.m.–noon (Central)

Gemini products are only sold  
through Authorized Resellers



GEMINI LETTERS, LOGOS  
AND PLAQUES ARE  
GUARANTEED FOR LIFE

## INTRODUCTION

- 1 Message from Fred
- 4 Mission & Values
- NEW** 6 Product and Pricing Platforms
- 7 Partner Portal & TrueQuote
- 8 Working With Gemini

# METAL LAMINATED PLASTIC ILLUMINATED PLAQUES

- 10 Flat Cut Metal
- 42 Cast Metal
- 60 Fabricated Metal

- 122 GemLeaf
- 134 Metal on Acrylic
- 148 Laminate on Foam

- 162 Flat Cut Acrylic
- 182 Formed & Injection Molded

- 196 Halo Lit
- 210 Face Lit
- 222 Specialty Lit

- 236 Precision Tooled
- 248 Cast
- 266 Etched
- 274 Thin Gauge

## ADDITIONAL INFORMATION

- 284 FAQ's
- 286 Guaranteed Ground Freight
- 287 Hardware
- 289 Patterns & Guides

### **THIS IMPORTANT NOTICE TO PURCHASER APPLIES TO ALL GEMINI PRODUCTS**

The following warranty is in lieu of all warranties expressed or implied. Specifically, Seller and Manufacturer disclaims any warranty of merchant-ability or of fitness for a particular purpose and manufacturer/seller's only obligation shall be to replace such quantity of the product proved to be defective. Neither seller nor manufacturer shall be liable for any injury, loss or damage, direct or consequential, arising out of the use of or the inability to use the product. Before using, user shall determine the suitability of the product for his or her intended use and user assumes all risk and liability whatsoever in connection therewith. The foregoing may not be altered except by an agreement signed by officers of seller and manufacturer.



## OUR MISSION

WE PROTECT AND IDENTIFY WHAT MATTERS.

Gemini has the expertise and capacity to handle any project. We have plants located in Minnesota, Iowa, Nevada, Texas and Virginia in the United States; Ontario, Canada; and Reynosa, Mexico. With a collective footprint of over 800,000 square feet, we have the capability to handle any customer project that comes our way – large or small.

**Our Made True approach sets Gemini apart in the industry** – beyond expertise, ability and capacity. Made True is how we go about our business in providing you the finest dimensional letters, logos and plaques.

## OUR VALUES

GEMINI INCORPORATES OUR MADE TRUE VALUES INTO EVERYTHING WE DO, EVERY DAY.

**Customer Focus** – Convenient, hassle-free customer service with top quality and an industry-leading guarantee.

**Respect** – A culture of integrity and humility. Treating others as we wish to be treated ourselves.

**Honesty** – Be authentic, genuine and transparent in our interactions with each other and our customers.

**Curiosity** – Seeking continuous improvement through new and innovative solutions.

**Teamwork** – We all have a passion to win – but in the end we win or lose together.

**Stability** – Reliability for our customers and our people through growth and investment in people and equipment

**Stewardship** – Supporting our industry, our local communities and the environment.

**Diversity** – Building stronger teams and solutions by leveraging diverse perspectives, knowledge and culture.



**GEMINI LETTERS, LOGOS  
AND PLAQUES ARE  
GUARANTEED FOR LIFE**

**Gemini guarantees all of its exterior products for life.** This means that should any Gemini produced product fade, break or contain any defect, we will refinish or replace the defective materials at no cost to you, as long as they are installed on their original location.

All Gemini products are designed to last a lifetime. We test all our materials and finishes, refine our coating technology, and deliver a product that we know will last much longer than the life of any other product you may install. From experience in the field and from our test lab results, we know that our products will last in excess of 10 years without any noticeable degradation in appearance. And we know, from many installations around the world, that many of our products last longer than that.

Please note that our guarantee applies to defective material only, as described in our warranty statement.



# Made True.

"THE QUALITY IS ALWAYS THE BEST AND THEY'RE CONSTANTLY IMPROVING AND PERFECTING THE PRODUCT. GREAT CUSTOMER SERVICE TOO!"

– MICHELLE, GEMINI PARTNER SINCE 1990

## THIS IS WHAT WE'RE MADE OF **GEMINI**MADE.COM

To deliver an improved user experience and advance our Made True promise across our organization, we've launched our **GeminiMade.com** corporate website. This new site will be the hub for all of our diverse products and services. Signage customers will want to link to **GeminiSignage.com**, our new site featuring powerful digital tools and resources designed to help our partners grow their businesses. Watch for announcements about Gemini's new web experience, coming soon.

For over 50 years, Gemini has done business **INSPIRED** by singular focus. A company **DESIGNED** solely to serve in a supportive role behind the efforts of the signage industry. And dedicated to providing solutions that are **MADE TRUE** in an enduring commitment to your success as our partner.

At Gemini, we are wholesale-only partners to the signage, graphics and recognition industries. And always will be. We support your business with product guidance, a focus on solutions as well as project management services. We offer delivery in days of the industry's widest selection of made-to-order signage products, and bring your most aspirational design visions to life with unsurpassed in-house custom fabrication and manufacturing capabilities.

Gemini has invested in advanced technologies, capabilities and materials so you don't have to. We manufacture many of our own raw materials to help keep your costs low while controlling risks, shortages and shipping delays. They call this "vertical integration". We call it investing in our partnership. With Gemini behind your business, even small shops can successfully compete for large projects.

The resources of Gemini allow our partners the agility to manage their business in the smartest ways. With fair pricing and economy of scale, we deliver industry-leading margins to our partners without compromise.

And of course, Gemini's legendary quality is guaranteed. If anything is ever wrong, you need only one call to make it right. That's our promise.



"EVERY SINGLE THING THAT I HAVE ORDERED IS ALWAYS THE SAME AS THE OFFERED PRODUCT AND MY CUSTOMERS ARE ALWAYS SATISFIED."

– RAUL, GEMINI PARTNER SINCE 1999



## GEMINI IS MAKING YOUR SUCCESS EASIER IN 2022

WE LISTENED TO YOU AND STREAMLINED OUR PRODUCT AND PRICING PLATFORMS

**Gemini is committed to your success.** That's why, after listening to our customers, we're streamlining our pricing, ordering and catalog in 2022 to provide faster solutions, simplify pricing, and make quotes and orders easier.

### **NEW** Simplified product and pricing platforms.

Previously, our pricing started with a base cost for letters, logos, plaques and plates. Each specification and option selected added on an additional cost to calculate a total wholesale price. You told us you want to simplify the process, and we're responding. We're excited to announce that beginning with all products quoted on or after January 3, 2022, you'll experience easier ways to work with Gemini.

"GEMINI IS ONE OF OUR FAVORITE COMPANIES TO WORK WITH; THEY MAKE IT A PLEASANT WORRY-FREE PROCESS."

– STEVEN, GEMINI PARTNER SINCE 1998

**NEW** Every order now includes a standard product package of what you need for your project. Our simplified pricing now reflects the addition of this package of standard options and accessories, including:

- Your choice of Standard Finishes
- Custom Formula Matched Paint where requested
- The Standard Mounting Hardware you select
- A recommended Installation Pattern
- Power Supply & 10' Lead Wire Cables for Illuminated Products

**NEW** If it's in here, you can quote it instantly with **TrueQuote**. ALL products and options in the ESSENTIALS catalog will be included in our new TrueQuote portal update (coming in 2022), so if it's in here, you can generate a quote online 24/7 that we stand behind 100%.

# YOUR PARTNER PORTAL

"GEMINI HAS ALWAYS EXCEEDED MY EXPECTATIONS. QUALITY IS OUTSTANDING. CUSTOMER SERVICE IS OUTSTANDING. IT'S A GREAT PARTNERSHIP."

– BOB, GEMINI PARTNER SINCE 2009

The Gemini Partner Portal serves as a central hub for your projects. Our TrueQuote online engine lets you price projects in realtime. Compare materials and configure product variations to help realize your budget goals and desired margins. Order, track and manage your projects easily online and access marketing materials samples to help you win your next project.

Join the Partner Portal today at no cost to you. Go to GeminiSignage.com and scroll to the bottom to find; **Partner With Gemini**

Stay tuned in 2022 for further portal updates to best serve your business needs.

## DIGITAL TOOLS AND RESOURCES AVAILABLE AT YOUR GEMINI PARTNER PORTAL

### ONLINE PARTNER TOOLS & RESOURCES



### ESTIMATING, ORDERING AND PROJECT MANAGEMENT

- TrueQuote access to configure, price and order your project
- Payment Portal
- Order Tracking
- Project History
- Artwork Uploads

### ONLINE RESOURCES

- Video Library
- Font Library
- Technical Resources
- Installation Guides
- Communication Archives

### SHOWROOM SAMPLES & SELECTION GUIDES



### PRODUCT AND MATERIAL SAMPLES

- Free Standard Product Samples
- Free Metal Material & Finish Chips
- Free Chemetal Laminate Chain
- Free GemTrim Sample Chain
- Free Duets® Swatch Chips
- Free Duets® Production Samples
- Additional Discount on Custom Product and Prototype Samples
- Sample Request Form

### SELECTION TOOLS

- Free Paint Color Chart
- Duets® Product Selection Guide
- Full Line Duets® Engraving Materials Swatch Binder (\$50 USD)

### ONLINE SALES & MARKETING TOOLS



### DIGITAL MARKETING ASSETS

- Enhanced Digital Catalogs
- Inspiration Portfolio Guide
- Sign & Letter Visibility Chart
- Product Specification Guides
- Product Sell Sheets
- Authorized Gemini Reseller Logo
- Website Images & Sales Content

Product sample requests are handled within 24-48 hours and shipped by ground service carrier. Expedited shipping (1-2 days) is available with your FedEx or UPS account number.

## Our samples help you win more projects.

Nothing convinces your customers like a product they can hold in their hands. To give you the tools you need to win, Gemini stands behind you with free samples of many of our most-requested letter, logo and plaque products. And if you want a custom prototype product made to your exact design specifications, we can do that too – at a vastly reduced cost.

For over 50 years, our policy has been simple: get samples in our resellers hands quickly so we can win more projects together.



### Gemini Sign Idea Starter Kit

Includes a selection of Gemini Letters, Logos and Plaque samples, plus our current catalog to help you price products options easily and quickly, and many tools to inspire your customers.

**Available at no cost to Gemini Partners.**



# WE MAKE IT EASY TO WORK TOGETHER

YOU'RE IN CONTROL AND GEMINI IS WITH YOU EVERY STEP OF THE WAY

## EXPLORE

**Sign solutions start here.** Choose from among a curated offering of the industry's most frequently specified product solutions in the Gemini ESSENTIALS Products & Pricing Guide

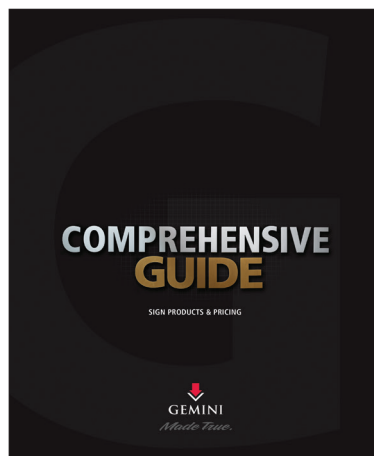
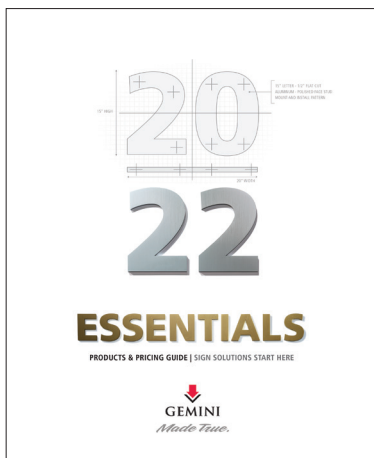

**Explore more possibilities.** If you need special product options or configurations not available in the ESSENTIALS Catalog, access Gemini's COMPREHENSIVE GUIDE to explore our full offering of products on our website: [GeminiSignage.com](http://GeminiSignage.com)

## DESIGN

### GEMINI PARTNER PORTAL ▼

Manage your letter, logo and plaque projects online, exclusively for Gemini Authorized Resellers



**Get started right** with our Jumpstart Guide to determine the specifications for your project



**Discover helpful resources** for your project in your Partner Portal; see page 7



**Get free product and material samples** to help your ideas take shape; learn more about samples on page 7

## QUOTE



**TrueQuote**

**Price your project instantly online with TrueQuote** available on your Gemini Partner Portal; calculate your margin and have 100% confidence in your pricing



**Get the answers you need** from our Partner Portal resources, and from our service teams and product experts, available by phone, email or chat

See answers to Frequently Asked Questions on page 198 and on the Partner Portal

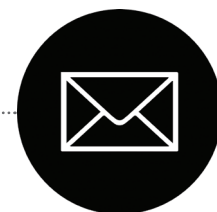

**Email your quote** and include artwork and specifications to [Signage@GeminiMade.com](mailto:Signage@GeminiMade.com)

## ORDER



**Place your order** using TrueQuote, or speak to our customer service team and place your order verbally



**Upload your vector artwork** through the TrueQuote tool or email your design files; learn more on page 201



**Email your order** and include artwork and specifications to [Signage@GeminiMade.com](mailto:Signage@GeminiMade.com)



**Simplify your payment** through our payment portal and get convenient terms with your approved credit

## FULFILL



**You can track the status of your order** through the production process on your Partner Portal

Large and/or complex orders receive art approval drawings



**Get low cost shipping** with Gemini's Guaranteed Ground Freight that offers predictable flat rates based on order value; see page 200 for rates and details

## SUPPORT



**Our commitment never ends.**

We stand behind everything we make with our lifetime guarantee against manufacturing defects and breakage

We keep a record of every order and can build replacements or modify your design if something needs to be changed

### BASIC SIGN PROJECT DESIGN AND BUILD CONSIDERATIONS CHECKLIST

- Environment: indoors or outdoors, UV exposure and weatherability as it relates to material choices
- Readability, visibility, placement, obstacles and traffic patterns as it relates to size and design parameters
- Local ordinances, federal codes and sign regulations, including ADA requirements
- Sign types, installation methods and challenges
- Engineering and technical requirements including site requirements
- Materials and sizes, including production requirements such as thickness, stroke width, availability and fabrication needs
- Aesthetics, font selection, logos, graphics and brand style guidelines
- Finishes and colors, natural finishes, paint, anodization, other visual effects and performance requirements
- Contrast and color interaction and relationship with surroundings
- Lighting sources, brightness and electrical requirements and codes
- Project budget and schedule





▲ The precision of laser cut metal captures the designer's hand-sketched feel to this detailed logo. Delicate strokes and fine serifs define the sophisticated lettering.

### FINE DETAIL

Intricate detail is a hallmark of Gemini metal letters and logos. From the accuracy of computer-guided cutting, to the refined elegance of our castings, to the exacting fit and finish of our hand-fabricated letters and logos, nobody works metal like Gemini.





## SOPHISTICATED. DURABLE. VERSATILE.

Gemini's handcrafted metal letters and logos offer impressive variety and customization options, combined with the strength and durability for any application, indoors or out. Choose from three versatile metal fabrication styles, in a variety of rich, durable materials offering dramatic depths, stylish finishes and virtually unlimited colors. You can achieve the sophisticated look and enduring performance you want, quickly and affordably.

### FLAT CUT METAL LETTERS & LOGOS



Minimum Height	Maximum Height	Maximum Size	Depth/Thickness	Application	Material
1/2"	95"	46 1/2" x 95"; larger sizes available as multi-piece	1/8, 1/4, 3/8, 1/2, 3/4 & 1" based on letter height & alloy	Indoor or Outdoor Use	Aluminum, brass, bronze, copper, stainless steel, or Cor-Ten® steel

### CAST METAL LETTERS & LOGOS



Minimum Height	Maximum Height	Maximum Size	Depth/Thickness	Application	Material
4"	64"	64" x 64"	Custom depths can be specified: 1/4" up to 3"	Indoor or Outdoor Use	Aluminum or bronze

### FABRICATED METAL LETTERS & LOGOS



Minimum Height	Maximum Height	Maximum Size	Depth/Thickness	Application	Material
2"	100"+	84" x 100"+	3/8" - 6" based on letter height & stroke	Indoor or Outdoor Use	Stainless steel or aluminum





## **PRECISION IN THE DETAILS**

For unsurpassed reproduction quality in your most intricate designs, our state-of-the-art lasers, CNC and water jets offer superior detail compared to router-cut alternatives used by others.



## CUT METAL

Aluminum, brass, bronze, stainless steel, Cor-Ten® or Copper

Six thicknesses and a variety of finishes

Letters and logos from 1/2 inch to 95 inches

Larger letters & logos available as multi-piece

Industry-leading lead times

### **COST-EFFECTIVE QUALITY**

Durable enough for outdoors, yet stylish enough for any boardroom, Gemini's flat cut metal is an excellent choice for a variety of signage projects. Flat cut metal letters and logos offer thinner strokes and have fewer design limitations than other product lines. We make your project easier with dozens of finishing options, take care of scrap recycling, provide a pattern and your choice of mounting hardware.



#### **WHEN ORDERING**

PLEASE SPECIFY:

- Install Environment
- Size (Height)
- Finish Selection
- Vector Art or Standard Font
- Thickness
- Install Method



## Aluminum: Painted Colors

 5687 White Approx PMS White	 2718 Ivory Approx PMS 7499	 4660 Desert Sand Approx PMS 7506	 0209 Grey Approx PMS 423	 4310 Dove Grey Approx PMS 431	 8090 Safety Green Approx PMS 809	 2037 Lemon Yellow Approx PMS 102	 2000 Yellow Approx PMS 108
 0217 Citrus Yellow Approx PMS 606	 0218 Sundance Yellow Approx PMS 116	 0254 Mango Approx PMS 137	 2119 Orange Approx PMS 21	 2662 Red-Orange Approx PMS 485	 0256 Rampart Orange Approx PMS 172	 2793 Red Approx PMS 185	 1875 Brick Red Approx PMS 7623
 2280 Black Cherry Approx PMS 1817	 2240 Maroon Approx PMS 202	 2410 Magenta Approx PMS 241	 2287 Purple Approx PMS 2695	 0246 Violet Toner Approx PMS 2725	 2767 Midnight Blue Approx PMS 5395	 2050 Dark Blue Approx PMS 281	 2860 Medium Blue Approx PMS 286
 3000 Blue Approx PMS 300	 2648 Light Blue Approx PMS 2995	 5425 Marine Reef Blue Approx PMS 5425	 3210 Teal Blue Approx PMS 321	 3555 Spring Green Approx PMS 355	 0222 Emerald Green Approx PMS 356	 0259 Federal Green Approx PMS 350	 2108 Light Green Approx PMS 3415
 2030 Dark Green Approx PMS 3435	 2162 Hunter Green Approx PMS 3308	 0400 Brilliant Gold Approx PMS 7556	 2756 Metallic Gold* Approx PMS 465	 0401 Aztec Gold Approx PMS 2317	 0253 Copper Approx PMS 7600	 0402 Aztec Copper Approx PMS 7599	 2418 Brown Approx PMS 476
 0312 Medium Bronze* Approx PMS 2335	 0314 Old Copper* Approx PMS 2334	 3130 Duranodic Bronze* Approx PMS 2336	 1315 Dark Oxide Approx PMS 447	 8886 Metallic Silver* Approx PMS 3435	 2025 Black Approx PMS Black		

### Custom Paint Color:

It's easy to request custom color matching! Simply tell us the paint number or name and brand of paint you'd like us to match (e.g. PMS 186 or Sherwin-Williams Boathouse Blue) and we will obtain a mixing formula at no cost to you.

Don't have a paint name or number and still need a color exactly matched? Please send us a sample (sample item must be at least 3" x 3") and our paint lab will run it through an exacting color match process. Exact color matching from a sample is \$200.



## Aluminum Alloy 5052: Brushed Finishes

#4 brushed, Random Arc & Orbital are available in all anodized finishes as well as aluminum, stainless steel, brass, bronze and copper.



Brushed



#4 Brushed



Random Arc

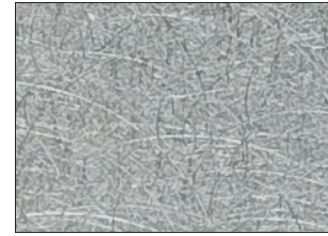

Orbital

## Aluminum: Anodized Finishes



Clear

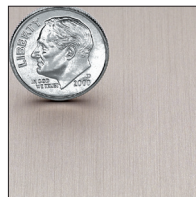

Champagne



Gold

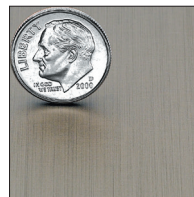

Light Bronze

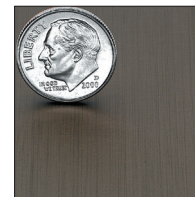

Medium Bronze

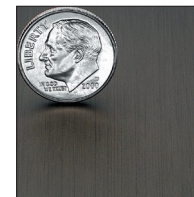

Dark Bronze

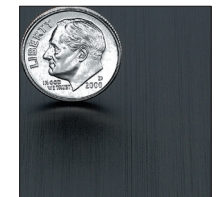

Black



Polished  
Clear

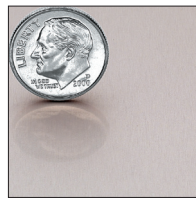

Polished  
Champagne

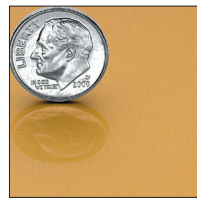

Polished  
Gold



Polished  
Light Bronze



Polished  
Medium Bronze

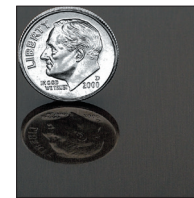

Polished  
Dark Bronze

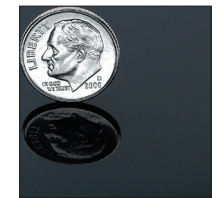

Polished  
Black

### Anodized Aluminum:

Anodized finishes are not just coatings... they are a part of the finished aluminum letter. Anodizing is an electrochemical process that hardens aluminum and allows it to be colored. We perform our own anodizing to ensure your letters within the same order have color consistency and are delivered to you within days. Some of the many reasons to have Gemini anodize your aluminum letters include: Abrasion and weather resistant; Beautiful finish; Increases hardness and durability; Will not crack or peel; Unaffected by sunlight / UV; Environmentally friendly; Cost effective. Note: Colors may vary slightly from order to order.

### Aluminum: Other Finishes



Polished

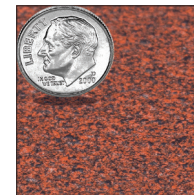

Rust Powdercoat



Primed for Paint

## Stainless Steel: Alloys 304 & 316 (1/8", 1/4", 3/8" & 1/2" Thick)



Brushed  
Alloy 304 & 316

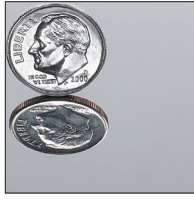

Polished  
Alloy 304 & 316

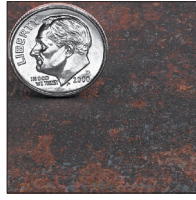

Cor-Ten®  
1/8" & 1/4" Only

### STAINLESS STEEL FINISH NOTES:

**ALLOY 304:** The standard "18/8" stainless; it is the most versatile and most widely used stainless steel. For areas within 50 miles of the coast, Gemini recommends Alloy 316

**ALLOY 316:** 316 offers better overall corrosion resistant properties than 304, particularly higher resistance to pitting and crevice corrosion in chloride environments.

**Cor-Ten®:** An environment resistant steel, created by alloying copper, chromium and nickel. The material forms its own continuing protective rust layer, when exposed to atmospheric elements. Essentially, the top layer corrodes, which then protects the steel beneath it – hence Cor-Ten cannot be painted or clear coated, as it will push off most surface surfactants over time. It is not recommended for mounting on any surface that could be stained, due to the bleeding of this rust layer.

**POLISHING:** Requires a minimum of .5" stroke at 1/8" thick (stud weld required). Restrictions may apply on letters/logos over 24".

## Brass: Alloy C464 (1/8", 1/4", 3/8", 1/2" & 3/4" Thick)



Brushed



Polished

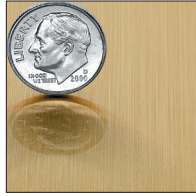

#4 Brushed

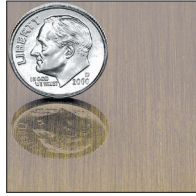

Light Oxidized

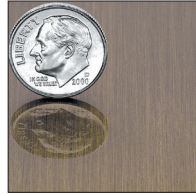

Oxidized

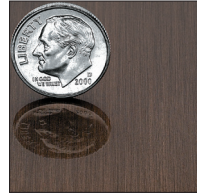

Dark Oxidized

## Bronze: Alloy C22000 (1/8", 1/4", 3/8" & 1/2" Thick)



Brushed



Polished



#4 Brushed



Light Oxidized



Oxidized

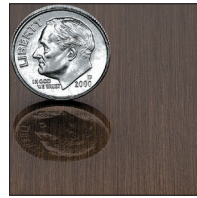

Dark Oxidized

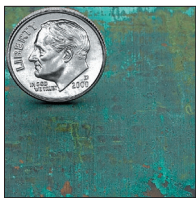

Verde Patina

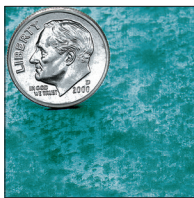

Turquoise Patina

### BRONZE, BRASS & COPPER FINISH NOTES:

**OXIDIZED:** Color matching of existing oxidized letters is available with a customer supplied sample.

**PATINA:** All Patinas, by their very nature, will vary from letter to letter and order to order. These finishes will change in appearance over time depending on contact with moisture and temperature. Patinas can "bleed" onto the installation surface when installed outside.

**POLISHING:** Requires a minimum of .5" stroke at 1/8" thick (stud weld required). Restrictions may apply on letters/logos over 24".

## Copper: Alloy C11000 (1/8", 1/4" & 3/8" Thick)



Brushed



Polished



#4 Brushed

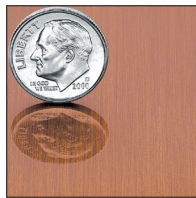

Light Oxidized

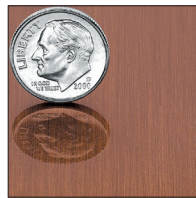

Oxidized

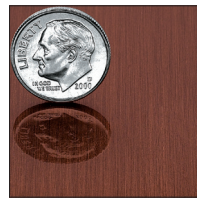

Dark Oxidized

## Mounting Options

Go to GeminiSignage.com to view, print or save .pdf CAD drawings of all mounting and construction options. (Flat Cut Metal > Installation)



### Plain Mount

Letters and logos are supplied with no mounting holes or hardware. Note: Most metal finishes do require some processing holes on letters backs - even with Plain mounts

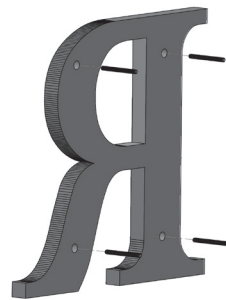

### Stud Mount

Backs of letters and logos, at least 1/4" thick, are drilled and tapped to receive threaded studs, for mounting to wall. Optional alignment for brick, block or rails.

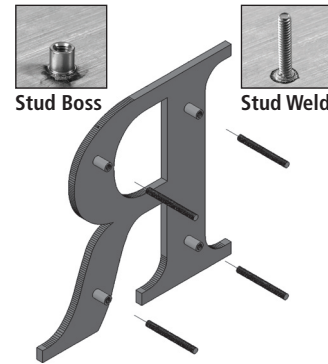

### Welded Stud Mount

Backs of 1/8" thick letters and logos are supplied with welded stud bosses (to receive studs) or 1" long welded studs, for mounting to wall.

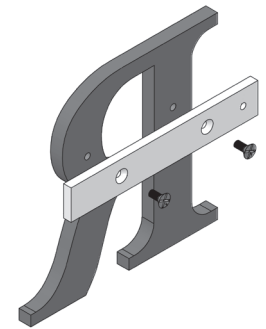

### Single Rail Mount

Add 35% to brushed letter price. Includes one flat 1/4" painted rail. Letters pre-assembled to rail. Typical with 4" - 8" letters. C-channel and anodized finish optional.

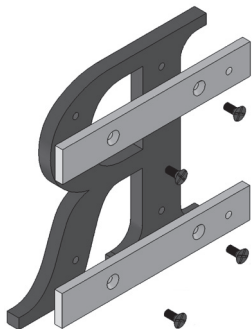

### 3A - Double Rail Mount

Add 35% to brushed letter price. Includes two flat 1/4" painted rails. Letters pre-assembled to rails. Typical with 4" - 24" letters. C-channel and anodized finish optional

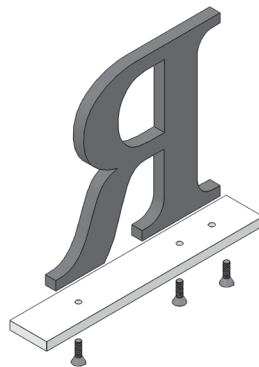

### 3B - Bottom & Top Rail Mount

Add 35% to brushed letter price. Letters 4"-30", Minimum 3/8" thick. Includes painted or anodized aluminum rail. Letters over 8" may require tie-back (not supplied).

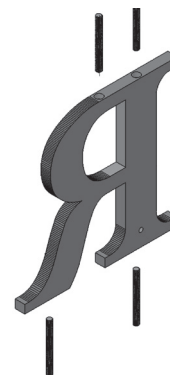

### 3B - Bottom & Top Stud Mount

Add 15% to brushed letter price. Letters 4"-30", Minimum 3/8" thick. Letters over 8" may require tie-back (not supplied).



### Double Face Tape Mount

Some letters or logos 8" or smaller can have full coverage, 20 mil. clear double face tape. Some larger letters and logos can have strips of the same tape applied. Email for quote.



# Standard Fonts

Adrianna Bold	<b>ABCDEFGH abc 123</b>	ClearviewOne-Bold	<b>ABCDEFGH abc 123</b>
Adrianna Demibold	<b>ABCDEFGH abc 123</b>	Comic Sans Bold	<b>ABCDEFGH abc 123</b>
Adrianna Extrabold	<b>ABCDEFGH abc 123</b>	Commercial Script	<i>ABCDEFGH abc 123</i>
Americana Bold	<b>ABCDEFGH abc 123</b>	Consort	<b>ABCDEFGH abc 123</b>
Antique Olive Medium	<b>ABCDEFGH abc 123</b>	Consort Condensed	<b>ABCDEFGH abc 123</b>
Architectural	<b>ABCDEFGH abc 123</b>	Cooper Black	<b>ABCDEFGH abc 123</b>
Arial	<b>ABCDEFGH abc 123</b>	Cooper Black Italic	<b>ABCDEFGH 123</b>
Arial Bold	<b>ABCDEFGH 123</b>	Copperplate	<b>ABCDEFGH 123</b>
Avant Extra Bold	<b>ABCDEFGH abc 123</b>	Craw Clarendon Condensed	<b>ABCDEFGH abc 123</b>
Avant Garde Medium	<b>ABCDEFGH abc 123</b>	Eurostyle Bold Extended	<b>ABCDEFGH 123</b>
Barnum	<b>ABCDEFGH 123</b>	Eurostyle Bold Extended Italic	<b>ABCDEFGH 123</b>
Barnum Classic	<b>ABCDEFGH 123</b>	Fairbanks	<b>ABCDEFGH abc 123</b>
Bauhaus	<b>ABCDEFGH abc 123</b>	Forward Thinking	<b>ABCDEFGH abc 123</b>
Benguiat	<b>ABCDEFGH abc 123</b>	Friz Quadrata	<b>ABCDEFGH abc 123</b>
Bodoni Condensed	<b>ABCDEFGH 123</b>	Frutiger 65	<b>ABCDEFGH abc 123</b>
Bodoni Italic	<b>ABCDEFGH abc 123</b>	Futura	<b>ABCDEFGH abc 123</b>
Brush Script	<i>ABCDEFGH abc 123</i>	Futura Demi Bold	<b>ABCDEFGH abc 123</b>
Caslon Adbold	<b>ABCDEFGH 123</b>	Futura Bold	<b>ABCDEFGH abc 123</b>
Casual Italic Script	<i>ABCDEFGH abc 123</i>	Futura Condensed	<b>ABCDEFGH abc 123</b>
Century Schoolbook Bold	<b>ABCDEFGH 123</b>	Futura Extra Bold Italic	<b>ABCDEFGH abc 123</b>
Century Bold Condensed	<b>ABCDEFGH abc 123</b>	Garamond Book	<b>ABCDEFGH abc 123</b>
Clarendon Fortune Bold	<b>ABCDEFGH abc 123</b>	Garamond Regular	<b>ABCDEFGH abc 123</b>
Clarendon Medium	<b>ABCDEFGH 123</b>	Garamond Italic	<i>ABCDEFGH abc 123</i>
Clarion	<b>ABCDEFGH 123</b>	Garamond Bold	<b>ABCDEFGH abc 123</b>
ClearviewOne-Light	<b>ABCDEFGH abc 123</b>	Garamond Bold Italic	<b>ABCDEFGH abc 123</b>
		Gil Sans Bold	<b>ABCDEFGH abc 123</b>

Goudy Extra Bold	<b>ABCDEFGH abc 123</b>	Roffe	ABCDEFGH 123
Goudy Old Style	ABCDEFGH abc 123	Roman	<b>ABCDEFGH abc 123</b>
Helvetica	<b>ABCDEFGH abc 123</b>	Roman Classic	<b>ABCDEFGH 123</b>
Helvetica Light	ABCDEFGH 123	Roman Neo SB	<b>ABCDEFGH 123</b>
Helvetica Medium Italic	<i><b>ABCDEFGH abc 123</b></i>	Sculptured	<b>ABCDEFGH</b>
Helvetica Bold	<b>ABCDEFGH abc 123</b>	Shopaganda Condensed	<b>ABCDEFGH abc 123</b>
Helvetica Medium Condensed	<b>ABCDEFGH abc 123</b>	Shopaganda Regular	<b>ABCDEFGH abc 123</b>
Helvetica Bold Extended	<b>ABCDEFGH abc 123</b>	Standard Block	<b>ABCDEFGH abc 123</b>
Herman Italic	<i><b>ABCDEFGH abc 123</b></i>	Standard Block Condensed	<b>ABCDEFGH 123</b>
Hydropower Extracondensed	<b>ABCDEFGH abc 123</b>	Stettler	ABCDEFGH 123
Impact	<b>ABCDEFGH abc 123</b>	Timeless Geometric	<b>ABCDEFGH abc 123</b>
Italicized Script	<i><b>ABCDEFGH abc 123</b></i>	Times Bold	<b>ABCDEFGH abc 123</b>
Kabel	ABCDEFGH 123	Times Bold Italic	<i><b>ABCDEFGH abc 123</b></i>
Kegger	<b>ABCDEFGH abc 123</b>	Times New Roman	ABCDEFGH abc 123
Lithos Bold	<b>ABCDEFGH 123</b>	Times New Roman Italic	<i><b>ABCDEFGH abc 123</b></i>
Microgramma Extended	ABCDEFGH 123	Times Roman	<b>ABCDEFGH abc 123</b>
Microgramma Bold Extended	<b>ABCDEFGH 123</b>	Trajan Bold	ABCDEFGH 123
Old English	<b>ABCDEFGH abc 123</b>	Twentieth Century	<b>ABCDEFGH 123</b>
Optima	ABCDEFGH abc 123	Univers 67	<b>ABCDEFGH abc 123</b>
Optima Semi Bold	<b>ABCDEFGH abc 123</b>	University Roman	ABCDEFGH abc 123
Palatino	ABCDEFGH abc 123	University Roman Bold	ABCDEFGH abc 123
Palatino Bold	<b>ABCDEFGH abc 123</b>	Venus	<b>ABCDEFGH 123</b>
Palatino Semi Bold	<b>ABCDEFGH 123</b>		
Ribbon	ABCDEFGH 123		
Ribbon Condensed	ABCDEFGH 123		

**CLICK HERE TO  
DOWNLOAD  
FONTS**



# 1/8" Thick Aluminum Letters

## PRICE PER LETTER: INCLUDING STANDARD MOUNTING WITH PATTERN

### 1/8" THICK

Size	Brushed or Painted	Anodized	#4 or Random Arc or Orbital or Rust	Polished	Polished Anodized
1" †	\$15.50	\$19.38	\$20.15	\$23.25	\$27.13
2	16.80	21.00	21.84	25.20	29.40
3	21.60	27.00	28.08	32.40	37.80
4	28.70	35.88	37.31	43.05	50.23
5	33.50	41.88	43.55	50.25	58.63
6	40.70	50.88	52.91	61.05	71.23
7	49.00	61.25	63.70	73.50	85.75
8	51.40	64.25	66.82	77.10	89.95
9	54.90	68.63	71.37	82.35	96.08
10	59.70	74.63	77.61	89.55	104.48
11	65.70	82.13	85.41	98.55	114.98
12	69.30	86.63	90.09	103.95	121.28
13	75.20	94.00	97.76	112.80	131.60
14	82.40	103.00	107.12	123.60	144.20
15	90.80	113.50	118.04	136.20	158.90
16	95.50	119.38	124.15	143.25	167.13
17	105.10	131.38	136.63	157.65	183.93
18	108.70	135.88	141.31	163.05	190.23
19	120.70	150.88	156.91	181.05	211.23
20	136.20	170.25	177.06	204.30	238.35
21	149.30	186.63	194.09	223.95	261.28
22	162.40	203.00	211.12	243.60	284.20
23	176.80	221.00	229.84	265.20	309.40
24	216.20	270.25	281.06	324.30	378.35
25" +	EMAIL FOR QUOTE				

LETTER HEIGHT - MAX DIMENSION

#### Additional Pricing Notes:

- Price includes either plain or stud mount and stencil / installation pattern
- Lower case is 75% of the corresponding Upper Case price
- Small punctuation, such as a comma, period and dash are 33% of the Upper Case price
- Studs required for polishing

**[CLICK HERE TO VIEW STANDARD PAINTED COLORS](#)**

† 1" Letters UPPER CASE ONLY.

#### Brushed or Painted

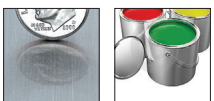

Brushed Painted

#### Anodized



Clear Champagne Gold Light Bronze Medium Bronze Dark Bronze Black

#### #4 or Random Arc or Orbital or Rust

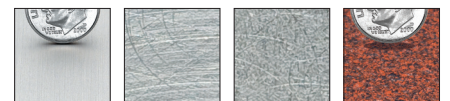

#4 Brushed Random Arc Orbital Rust Powdercoat

#### Polished



Polished

#### Polished Anodized



Clear Champagne Gold Light Bronze Medium Bronze Dark Bronze Black

# 1/4" Thick Aluminum Letters

PRICE PER LETTER: INCLUDING STANDARD MOUNTING WITH PATTERN

## 1/4" THICK

Size	Brushed or Painted	Anodized	#4 or Random Arc or Orbital or Rust	Polished	Polished Anodized
1" †	\$15.50	\$19.38	\$20.15	\$23.25	\$27.13
2	16.80	21.00	21.84	25.20	29.40
3	21.60	27.00	28.08	32.40	37.80
4	28.70	35.88	37.31	43.05	50.23
5	33.50	41.88	43.55	50.25	58.63
6	40.70	50.88	52.91	61.05	71.23
7	49.00	61.25	63.70	73.50	85.75
8	51.40	64.25	66.82	77.10	89.95
9	54.90	68.63	71.37	82.35	96.08
10	59.70	74.63	77.61	89.55	104.48
11	65.70	82.13	85.41	98.55	114.98
12	69.30	86.63	90.09	103.95	121.28
13	75.20	94.00	97.76	112.80	131.60
14	82.40	103.00	107.12	123.60	144.20
15	90.80	113.50	118.04	136.20	158.90
16	95.50	119.38	124.15	143.25	167.13
17	105.10	131.38	136.63	157.65	183.93
18	108.70	135.88	141.31	163.05	190.23
19	120.70	150.88	156.91	181.05	211.23
20	136.20	170.25	177.06	204.30	238.35
21	149.30	186.63	194.09	223.95	261.28
22	162.40	203.00	211.12	243.60	284.20
23	176.80	221.00	229.84	265.20	309.40
24	216.20	270.25	281.06	324.30	378.35
25	231.70	289.63	301.21	347.55	405.48
26	252.00	315.00	327.60	378.00	441.00
27	271.10	338.88	352.43	406.65	474.43
28	291.40	364.25	378.82	437.10	509.95
29	312.90	391.13	406.77	469.35	547.58
30	334.30	417.88	434.59	501.45	585.03
31	357.00	446.25	464.10	535.50	624.75
32	380.90	476.13	495.17	571.35	666.58
33	403.60	504.50	524.68	605.40	706.30
34	428.70	535.88	557.31	643.05	750.23
35	455.00	568.75	591.50	682.50	796.25
36	480.00	600.00	624.00	720.00	840.00
37" +	EMAIL FOR QUOTE				

LETTER HEIGHT - MAX DIMENSION

- Additional Pricing Notes:**
- Price includes either plain or stud mount and stencil / installation pattern
  - Lower case is 75% of the corresponding Upper Case price
  - Small punctuation, such as a comma, period and dash are 33% of the Upper Case price
  - Studs required for polishing

**CLICK HERE TO VIEW  
STANDARD PAINTED COLORS**

**Brushed or Painted**

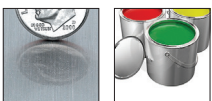

Brushed Painted

**Anodized**



Clear Champagne Gold Light Bronze Medium Bronze Dark Bronze Black

**#4 or Random Arc or Orbital or Rust**

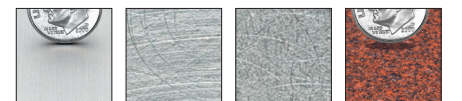

#4 Brushed Random Arc Orbital Rust Powdercoat

**Polished**



Polished

**Polished Anodized**



Clear Champagne Gold Light Bronze Medium Bronze Dark Bronze Black

# 3/8" Thick Aluminum Letters

## PRICE PER LETTER: INCLUDING STANDARD MOUNTING WITH PATTERN

### 3/8" THICK

Size	Brushed or Painted	Anodized	#4 or Random Arc or Orbital or Rust	Polished	Polished Anodized
2"	\$27.50	\$34.38	\$35.75	\$41.25	\$48.13
3	32.30	40.38	41.99	48.45	56.53
4	43.00	53.75	55.90	64.50	75.25
5	50.20	62.75	65.26	75.30	87.85
6	53.80	67.25	69.94	80.70	94.15
7	66.90	83.63	86.97	100.35	117.08
8	71.60	89.50	93.08	107.40	125.30
9	78.80	98.50	102.44	118.20	137.90
10	84.90	106.13	110.37	127.35	148.58
11	90.80	113.50	118.04	136.20	158.90
12	99.10	123.88	128.83	148.65	173.43
13	106.30	132.88	138.19	159.45	186.03
14	117.10	146.38	152.23	175.65	204.93
15	131.30	164.13	170.69	196.95	229.78
16	145.70	182.13	189.41	218.55	254.98
17	157.60	197.00	204.88	236.40	275.80
18	172.00	215.00	223.60	258.00	301.00
19	186.30	232.88	242.19	279.45	326.03
20	200.70	250.88	260.91	301.05	351.23
21	214.90	268.63	279.37	322.35	376.08
22	230.40	288.00	299.52	345.60	403.20
23	247.30	309.13	321.49	370.95	432.78
24	259.20	324.00	336.96	388.80	453.60
25	275.90	344.88	358.67	413.85	482.83
26	292.60	365.75	380.38	438.90	512.05
27	312.90	391.13	406.77	469.35	547.58
28	332.00	415.00	431.60	498.00	581.00
29	349.80	437.25	454.74	524.70	612.15
30	371.40	464.25	482.82	557.10	649.95
31	403.60	504.50	524.68	605.40	706.30
32	439.40	549.25	571.22	659.10	768.95
33	472.80	591.00	614.64	709.20	827.40
34	508.60	635.75	661.18	762.90	890.05
35	544.50	680.63	707.85	816.75	952.88
36	576.70	720.88	749.71	865.05	1,009.23
37"+	EMAIL FOR QUOTE				

LETTER HEIGHT - MAX DIMENSION

#### Additional Pricing Notes:

- Price includes either plain or stud mount and stencil / installation pattern
- Lower case is 75% of the corresponding Upper Case price
- Small punctuation, such as a comma, period and dash are 33% of the Upper Case price
- Studs required for polishing

**CLICK HERE TO VIEW  
STANDARD PAINTED COLORS**

#### Brushed or Painted



Brushed Painted

#### Anodized



Clear Champagne Gold Light Bronze Medium Bronze Dark Bronze Black

#### #4 or Random Arc or Orbital or Rust

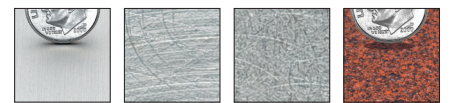

#4 Brushed Random Arc Orbital Rust Powdercoat

#### Polished



Polished

#### Polished Anodized

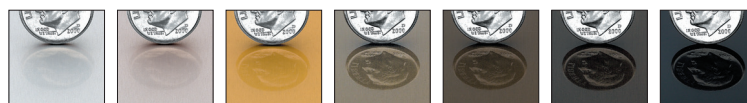

Clear Champagne Gold Light Bronze Medium Bronze Dark Bronze Black



# 1/2" Thick Aluminum Letters

PRICE PER LETTER: INCLUDING STANDARD MOUNTING WITH PATTERN

## 1/2" THICK

Size	Brushed or Painted	Anodized	#4 or Random Arc or Orbital or Rust	Polished	Polished Anodized
2"	\$37.10	\$46.38	\$48.23	\$55.65	\$64.93
3	44.30	55.38	57.59	66.45	77.53
4	51.40	64.25	66.82	77.10	89.95
5	58.50	73.13	76.05	87.75	102.38
6	65.70	82.13	85.41	98.55	114.98
7	72.90	91.13	94.77	109.35	127.58
8	76.70	95.88	99.71	115.05	134.23
9	86.00	107.50	111.80	129.00	150.50
10	90.80	113.50	118.04	136.20	158.90
11	104.00	130.00	135.20	156.00	182.00
12	114.60	143.25	148.98	171.90	200.55
13	130.20	162.75	169.26	195.30	227.85
14	144.50	180.63	187.85	216.75	252.88
15	158.80	198.50	206.44	238.20	277.90
16	174.30	217.88	226.59	261.45	305.03
17	197.10	246.38	256.23	295.65	344.93
18	217.30	271.63	282.49	325.95	380.28
19	235.30	294.13	305.89	352.95	411.78
20	259.20	324.00	336.96	388.80	453.60
21	281.80	352.25	366.34	422.70	493.15
22	304.50	380.63	395.85	456.75	532.88
23	326.00	407.50	423.80	489.00	570.50
24	347.50	434.38	451.75	521.25	608.13
25	370.10	462.63	481.13	555.15	647.68
26	394.00	492.50	512.20	591.00	689.50
27	417.90	522.38	543.27	626.85	731.33
28	444.20	555.25	577.46	666.30	777.35
29	468.10	585.13	608.53	702.15	819.18
30	495.50	619.38	644.15	743.25	867.13
31	538.60	673.25	700.18	807.90	942.55
32	586.30	732.88	762.19	879.45	1,026.03
33	635.20	794.00	825.76	952.80	1,111.60
34	683.00	853.75	887.90	1,024.50	1,195.25
35	729.60	912.00	948.48	1,094.40	1,276.80
36	777.30	971.63	1,010.49	1,165.95	1,360.28
37"+	EMAIL FOR QUOTE				

LETTER HEIGHT - MAX DIMENSION

- Additional Pricing Notes:**
- Price includes either plain or stud mount and stencil / installation pattern
  - Lower case is 75% of the corresponding Upper Case price
  - Small punctuation, such as a comma, period and dash are 33% of the Upper Case price
  - Studs required for polishing

**CLICK HERE TO VIEW STANDARD PAINTED COLORS**

**Brushed or Painted**

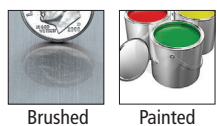

**Anodized**

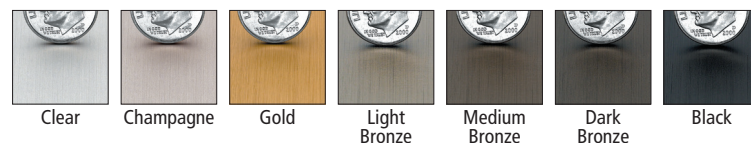

**#4 or Random Arc or Orbital or Rust**

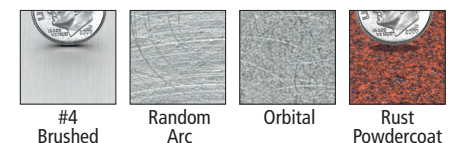

**Polished**



**Polished Anodized**



# 3/4" Thick Aluminum Letters

## PRICE PER LETTER: INCLUDING STANDARD MOUNTING WITH PATTERN

### 3/4" THICK

Size	Brushed or Painted	Anodized	#4 or Random Arc or Orbital or Rust	Polished	Polished Anodized
2"	\$41.80	\$52.25	\$54.34	\$62.70	\$73.15
3	49.00	61.25	63.70	73.50	85.75
4	54.90	68.63	71.37	82.35	96.08
5	63.30	79.13	82.29	94.95	110.78
6	75.20	94.00	97.76	112.80	131.60
7	92.00	115.00	119.60	138.00	161.00
8	105.10	131.38	136.63	157.65	183.93
9	119.40	149.25	155.22	179.10	208.95
10	136.20	170.25	177.06	204.30	238.35
11	154.10	192.63	200.33	231.15	269.68
12	176.80	221.00	229.84	265.20	309.40
13	199.50	249.38	259.35	299.25	349.13
14	222.10	277.63	288.73	333.15	388.68
15	247.30	309.13	321.49	370.95	432.78
16	277.00	346.25	360.10	415.50	484.75
17	311.70	389.63	405.21	467.55	545.48
18	345.10	431.38	448.63	517.65	603.93
19	379.70	474.63	493.61	569.55	664.48
20	414.40	518.00	538.72	621.60	725.20
21	452.50	565.63	588.25	678.75	791.88
22	489.50	611.88	636.35	734.25	856.63
23	526.60	658.25	684.58	789.90	921.55
24	566.00	707.50	735.80	849.00	990.50
25	593.50	741.88	771.55	890.25	1,038.63
26	626.90	783.63	814.97	940.35	1,097.08
27	658.00	822.50	855.40	987.00	1,151.50
28	691.30	864.13	898.69	1,036.95	1,209.78
29	727.20	909.00	945.36	1,090.80	1,272.60
30	764.10	955.13	993.33	1,146.15	1,337.18
31	860.90	1,076.13	1,119.17	1,291.35	1,506.58
32	961.20	1,201.50	1,249.56	1,441.80	1,682.10
33	1,061.50	1,326.88	1,379.95	1,592.25	1,857.63
34	1,158.10	1,447.63	1,505.53	1,737.15	2,026.68
35	1,259.70	1,574.63	1,637.61	1,889.55	2,204.48
36	1,385.00	1,731.25	1,800.50	2,077.50	2,423.75
37"+	EMAIL FOR QUOTE				

LETTER HEIGHT - MAX DIMENSION

#### Additional Pricing Notes:

- Price includes either plain or stud mount and stencil / installation pattern
- Lower case is 75% of the corresponding Upper Case price
- Small punctuation, such as a comma, period and dash are 33% of the Upper Case price
- Studs required for polishing

**CLICK HERE TO VIEW  
STANDARD PAINTED COLORS**

#### Brushed or Painted

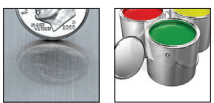

Brushed Painted

#### Anodized



Clear Champagne Gold Light Bronze Medium Bronze Dark Bronze Black

#### #4 or Random Arc or Orbital or Rust

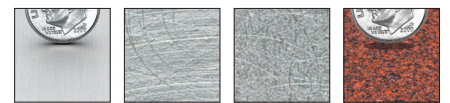

#4 Brushed Random Arc Orbital Rust Powdercoat

#### Polished



Polished

#### Polished Anodized



Clear Champagne Gold Light Bronze Medium Bronze Dark Bronze Black

# 1" Thick Aluminum Letters

PRICE PER LETTER: INCLUDING STANDARD MOUNTING WITH PATTERN

## 1" THICK

Size	Brushed or Painted	Anodized	#4 or Random Arc or Orbital or Rust	Polished	Polished Anodized
2"	\$49.00	\$61.25	\$63.70	\$73.50	\$85.75
3	53.80	67.25	69.94	80.70	94.15
4	62.10	77.63	80.73	93.15	108.68
5	72.90	91.13	94.77	109.35	127.58
6	83.60	104.50	108.68	125.40	146.30
7	101.50	126.88	131.95	152.25	177.63
8	120.70	150.88	156.91	181.05	211.23
9	144.50	180.63	187.85	216.75	252.88
10	172.00	215.00	223.60	258.00	301.00
11	200.70	250.88	260.91	301.05	351.23
12	229.30	286.63	298.09	343.95	401.28
13	261.50	326.88	339.95	392.25	457.63
14	295.00	368.75	383.50	442.50	516.25
15	327.20	409.00	425.36	490.80	572.60
16	367.80	459.75	478.14	551.70	643.65
17	409.50	511.88	532.35	614.25	716.63
18	452.50	565.63	588.25	678.75	791.88
19	505.10	631.38	656.63	757.65	883.93
20	563.60	704.50	732.68	845.40	986.30
21	622.10	777.63	808.73	933.15	1,088.68
22	683.00	853.75	887.90	1,024.50	1,195.25
23	746.30	932.88	970.19	1,119.45	1,306.03
24	813.20	1,016.50	1,057.16	1,219.80	1,423.10
25	866.80	1,083.50	1,126.84	1,300.20	1,516.90
26	922.90	1,153.63	1,199.77	1,384.35	1,615.08
27	980.30	1,225.38	1,274.39	1,470.45	1,715.53
28	1,038.70	1,298.38	1,350.31	1,558.05	1,817.73
29	1,095.00	1,368.75	1,423.50	1,642.50	1,916.25
30	1,161.70	1,452.13	1,510.21	1,742.55	2,032.98
31	1,262.10	1,577.63	1,640.73	1,893.15	2,208.68
32	1,373.00	1,716.25	1,784.90	2,059.50	2,402.75
33	1,482.90	1,853.63	1,927.77	2,224.35	2,595.08
34	1,592.80	1,991.00	2,070.64	2,389.20	2,787.40
35	1,702.60	2,128.25	2,213.38	2,553.90	2,979.55
36	1,811.30	2,264.13	2,354.69	2,716.95	3,169.78
37"+	EMAIL FOR QUOTE				

LETTER HEIGHT - MAX DIMENSION

- Additional Pricing Notes:**
- Price includes either plain or stud mount and stencil / installation pattern
  - Lower case is 75% of the corresponding Upper Case price
  - Small punctuation, such as a comma, period and dash are 33% of the Upper Case price
  - Studs required for polishing

**CLICK HERE TO VIEW STANDARD PAINTED COLORS**

**Brushed or Painted**

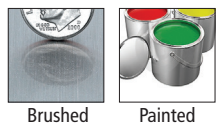

**Anodized**

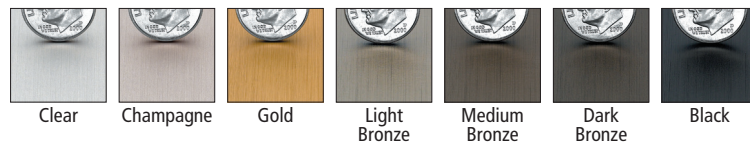

**#4 or Random Arc or Orbital or Rust**

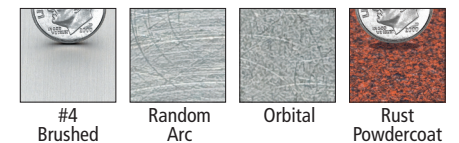

**Polished**



**Polished Anodized**





# 1/8" Thick Brushed or Painted Aluminum Logos



Threaded boss welded to back of 1/8" material to receive studs.

**PRICE PER LOGO.** Including standard mounting with pattern.

Size	10"	12"	14"	16"	18"	20"	22"	24"	26"	28"	30"*	32"*	34"*	36"*	38"*	40"*	42"*	44"*	46"*	48"*
10"	\$60.82	\$72.99	\$85.15	\$97.32	\$109.48	\$121.64	\$133.81	\$145.97	\$158.14	\$170.30	\$182.47	\$194.63	\$206.80	\$218.96	\$231.12	\$243.29	\$255.45	\$267.62	\$279.78	\$291.95
11	66.90	80.29	93.67	107.05	120.43	133.81	147.19	160.57	173.95	187.33	200.71	214.09	227.48	240.86	254.24	267.62	281.00	294.38	307.76	321.14
12	72.99	87.58	102.18	116.78	131.38	145.97	160.57	175.17	189.77	204.36	218.96	233.56	248.16	262.75	277.35	291.95	306.54	321.14	335.74	350.34
13	79.07	94.88	110.70	126.51	142.32	158.14	173.95	189.77	205.58	221.39	237.21	253.02	268.84	284.65	300.46	316.28	332.09	347.90	363.72	379.53
14	85.15	102.18	119.21	136.24	153.27	170.30	187.33	204.36	221.39	238.42	255.45	272.48	289.52	306.54	323.57	340.60	357.63	374.66	391.69	408.73
15	91.23	109.48	127.73	145.97	164.22	182.47	200.71	218.96	237.21	255.45	273.70	291.95	310.20	328.44	346.69	364.93	383.18	401.43	419.67	437.92
16	97.32	116.78	136.24	155.70	175.17	194.63	214.09	233.56	253.02	272.48	291.95	311.41	330.88	350.34	369.80	389.26	408.73	428.19	447.65	467.11
17	103.40	124.08	144.76	165.44	186.12	206.80	227.47	248.15	268.83	289.51	310.19	330.87	351.56	372.23	392.91	413.59	434.27	454.95	475.63	496.31
18	109.48	131.38	153.27	175.17	197.06	218.96	240.86	262.75	284.65	306.54	328.44	350.34	372.24	394.13	416.02	437.92	459.82	481.71	503.61	525.50
19	115.56	138.67	161.79	184.90	208.01	231.12	254.24	277.35	300.46	323.57	346.69	369.80	392.92	416.02	439.14	462.25	485.36	508.47	531.59	554.70
20	121.64	145.97	170.30	194.63	218.96	243.29	267.62	291.95	316.28	340.60	364.93	389.26	413.60	437.92	462.25	486.58	510.91	535.24	559.56	583.89
21	127.73	153.27	178.82	204.36	229.91	255.45	281.00	306.54	332.09	357.63	383.18	408.73	434.28	459.82	485.36	510.91	536.45	562.00	587.54	613.09
22	133.81	160.57	187.33	214.09	240.86	267.62	294.38	321.14	347.90	374.66	401.43	428.19	454.95	481.71	508.47	535.24	562.00	588.76	615.52	642.28
23	139.89	167.87	195.85	223.83	251.80	279.78	307.76	335.74	363.72	391.69	419.67	447.65	475.63	503.61	531.59	559.56	587.54	615.52	643.50	671.48
24	145.97	175.17	204.36	233.56	262.75	291.95	321.14	350.34	379.53	408.73	437.92	467.11	496.31	525.50	554.70	583.89	613.09	642.28	671.48	700.67
25	152.06	182.47	212.88	243.29	273.70	304.11	334.52	364.93	395.34	425.76	456.17	486.58	516.99	547.40	577.81	608.22	638.63	669.04	699.46	729.87
26	158.14	189.77	221.39	253.02	284.65	316.28	347.90	379.53	411.16	442.79	474.41	506.04	537.67	569.30	600.92	632.55	664.18	695.81	727.43	759.06
27	164.22	197.06	229.91	262.75	295.60	328.44	361.28	394.13	426.97	459.82	492.66	525.50	558.35	591.19	624.04	656.88	689.72	722.57	755.41	788.26
28	170.30	204.36	238.42	272.48	306.54	340.60	374.66	408.73	442.79	476.85	510.91	544.97	579.03	613.09	647.15	681.21	715.27	749.33	783.39	817.45
29	176.38	211.66	246.94	282.21	317.49	352.77	388.05	423.32	458.60	493.88	529.15	564.43	599.71	634.98	670.26	705.54	740.81	776.09	811.37	846.64
30*	182.47	218.96	255.45	291.95	328.44	364.93	401.43	437.92	474.41	510.91	547.40	583.89	620.39	656.88	693.37	729.87	766.36	802.85	839.35	875.84

**LOGOS SMALLER THAN 10" X 10" CAN BE PRICED AS A LETTER USING THE MAXIMUM DIMENSION**  
**LOGOS LARGER THAN SIZES SHOWN OR CONTAINING 31+ PIECES/CUTOUTS**  
**EMAIL: [Signage@GeminiMade.com](mailto:Signage@GeminiMade.com)**

## Aluminum Finishes

— Price as Listed —



Brushed Painted

**CLICK HERE TO VIEW STANDARD PAINTED COLORS**

Add 25%- Brushed Anodized

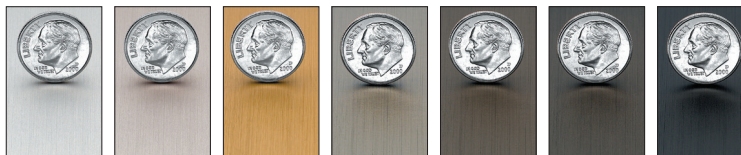

Clear Champagne Gold Light Bronze Medium Bronze Dark Bronze Black

Add 30%

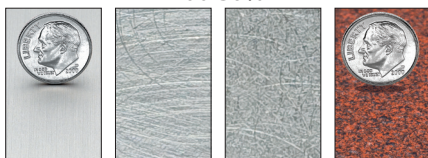

#4 Brushed Random Arc Orbital Rust Powdercoat

Add 50%

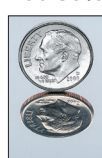

Polished

Add 75%- Polished Anodized

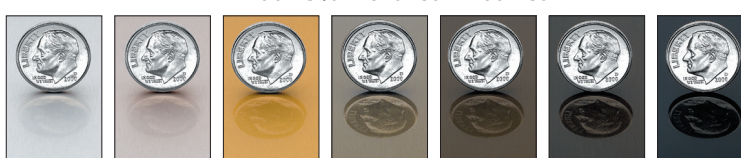

Clear Champagne Gold Light Bronze Medium Bronze Dark Bronze Black

# 1/4" Thick Brushed or Painted Aluminum Logos

PRICE PER LOGO. Including standard mounting with pattern.

Size	10"	12"	14"	16"	18"	20"	22"	24"	26"	28"	30"*	32"*	34"*	36"*	38"*	40"*	42"*	44"*	46"*	48"*
10"	\$60.82	\$72.99	\$85.15	\$97.32	\$109.48	\$121.64	\$133.81	\$145.97	\$158.14	\$170.30	\$182.47	\$194.63	\$206.80	\$218.96	\$231.12	\$243.29	\$255.45	\$267.62	\$279.78	\$291.95
11	66.90	80.29	93.67	107.05	120.43	133.81	147.19	160.57	173.95	187.33	200.71	214.09	227.48	240.86	254.24	267.62	281.00	294.38	307.76	321.14
12	72.99	87.58	102.18	116.78	131.38	145.97	160.57	175.17	189.77	204.36	218.96	233.56	248.16	262.75	277.35	291.95	306.54	321.14	335.74	350.34
13	79.07	94.88	110.70	126.51	142.32	158.14	173.95	189.77	205.58	221.39	237.21	253.02	268.84	284.65	300.46	316.28	332.09	347.90	363.72	379.53
14	85.15	102.18	119.21	136.24	153.27	170.30	187.33	204.36	221.39	238.42	255.45	272.48	289.52	306.54	323.57	340.60	357.63	374.66	391.69	408.73
15	91.23	109.48	127.73	145.97	164.22	182.47	200.71	218.96	237.21	255.45	273.70	291.95	310.20	328.44	346.69	364.93	383.18	401.43	419.67	437.92
16	97.32	116.78	136.24	155.70	175.17	194.63	214.09	233.56	253.02	272.48	291.95	311.41	330.88	350.34	369.80	389.26	408.73	428.19	447.65	467.11
17	103.40	124.08	144.76	165.44	186.12	206.80	227.47	248.15	268.83	289.51	310.19	330.87	351.56	372.23	392.91	413.59	434.27	454.95	475.63	496.31
18	109.48	131.38	153.27	175.17	197.06	218.96	240.86	262.75	284.65	306.54	328.44	350.34	372.24	394.13	416.02	437.92	459.82	481.71	503.61	525.50
19	115.56	138.67	161.79	184.90	208.01	231.12	254.24	277.35	300.46	323.57	346.69	369.80	392.92	416.02	439.14	462.25	485.36	508.47	531.59	554.70
20	121.64	145.97	170.30	194.63	218.96	243.29	267.62	291.95	316.28	340.60	364.93	389.26	413.60	437.92	462.25	486.58	510.91	535.24	559.56	583.89
21	127.73	153.27	178.82	204.36	229.91	255.45	281.00	306.54	332.09	357.63	383.18	408.73	434.28	459.82	485.36	510.91	536.45	562.00	587.54	613.09
22	133.81	160.57	187.33	214.09	240.86	267.62	294.38	321.14	347.90	374.66	401.43	428.19	454.95	481.71	508.47	535.24	562.00	588.76	615.52	642.28
23	139.89	167.87	195.85	223.83	251.80	279.78	307.76	335.74	363.72	391.69	419.67	447.65	475.63	503.61	531.59	559.56	587.54	615.52	643.50	671.48
24	145.97	175.17	204.36	233.56	262.75	291.95	321.14	350.34	379.53	408.73	437.92	467.11	496.31	525.50	554.70	583.89	613.09	642.28	671.48	700.67
25	152.06	182.47	212.88	243.29	273.70	304.11	334.52	364.93	395.34	425.76	456.17	486.58	516.99	547.40	577.81	608.22	638.63	669.04	699.46	729.87
26	158.14	189.77	221.39	253.02	284.65	316.28	347.90	379.53	411.16	442.79	474.41	506.04	537.67	569.30	600.92	632.55	664.18	695.81	727.43	759.06
27	164.22	197.06	229.91	262.75	295.60	328.44	361.28	394.13	426.97	459.82	492.66	525.50	558.35	591.19	624.04	656.88	689.72	722.57	755.41	788.26
28	170.30	204.36	238.42	272.48	306.54	340.60	374.66	408.73	442.79	476.85	510.91	544.97	579.03	613.09	647.15	681.21	715.27	749.33	783.39	817.45
29	176.38	211.66	246.94	282.21	317.49	352.77	388.05	423.32	458.60	493.88	529.15	564.43	599.71	634.98	670.26	705.54	740.81	776.09	811.37	846.64
30*	182.47	218.96	255.45	291.95	328.44	364.93	401.43	437.92	474.41	510.91	547.40	583.89	620.39	656.88	693.37	729.87	766.36	802.85	839.35	875.84

**LOGOS SMALLER THAN 10" X 10" CAN BE PRICED AS A LETTER USING THE MAXIMUM DIMENSION**  
**LOGOS LARGER THAN SIZES SHOWN OR CONTAINING 31+ PIECES/CUTOUTS**  
**EMAIL: [Signage@GeminiMade.com](mailto:Signage@GeminiMade.com)**

## Aluminum Finishes

— Price as Listed —



**CLICK HERE TO VIEW  
STANDARD PAINTED  
COLORS**

— Add 25% - Brushed Anodized —



— Add 30% —

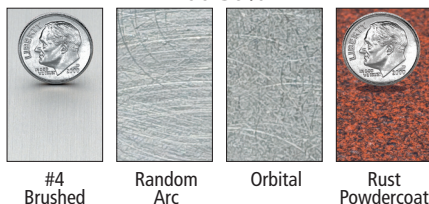

— Add 50% —

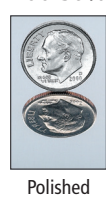

— Add 75% - Polished Anodized —



# 3/8" Thick Brushed or Painted Aluminum Logos

**PRICE PER LOGO.** Including standard mounting with pattern.

Size	10"	12"	14"	16"	18"	20"	22"	24"	26"	28"	30"*	32"*	34"*	36"*	38"*	40"*	42"*	44"*	46"*	48"*
10"	\$81.50	\$97.80	\$114.10	\$130.40	\$146.70	\$163.00	\$179.30	\$195.60	\$211.91	\$228.21	\$244.51	\$260.81	\$277.11	\$293.41	\$309.71	\$326.01	\$342.31	\$358.61	\$374.91	\$391.21
11	89.65	107.58	125.51	143.44	161.37	179.30	197.23	215.17	233.10	251.03	268.96	286.89	304.82	322.75	340.68	358.61	376.54	394.47	412.40	430.33
12	97.80	117.36	136.92	156.48	176.04	195.60	215.17	234.73	254.29	273.85	293.41	312.97	332.53	352.09	371.65	391.21	410.77	430.33	449.89	469.45
13	105.95	127.14	148.33	169.52	190.71	211.91	233.10	254.29	275.48	296.67	317.86	339.05	360.24	381.43	402.62	423.81	445.00	466.19	487.38	508.57
14	114.10	136.92	159.74	182.56	205.38	228.21	251.03	273.85	296.67	319.49	342.31	365.13	387.95	410.77	433.59	456.41	479.23	502.05	524.87	547.69
15	122.25	146.70	171.15	195.60	220.06	244.51	268.96	293.41	317.86	342.31	366.76	391.21	415.66	440.11	464.56	489.01	513.46	537.91	562.36	586.81
16	130.40	156.48	182.56	208.64	234.73	260.81	286.89	312.97	339.05	365.13	391.21	417.29	443.37	469.45	495.53	521.61	547.69	573.77	599.85	625.93
17	138.55	166.26	193.97	221.69	249.40	277.11	304.82	332.53	360.24	387.95	415.66	443.37	471.08	498.79	526.50	554.21	581.92	609.63	637.35	665.06
18	146.70	176.04	205.38	234.73	264.07	293.41	322.75	352.09	381.43	410.77	440.11	469.45	498.79	528.13	557.47	586.81	616.15	645.50	674.84	704.18
19	154.85	185.82	216.80	247.77	278.74	309.71	340.68	371.65	402.62	433.59	464.56	495.53	526.50	557.47	588.44	619.41	650.39	681.36	712.33	743.30
20	163.00	195.60	228.21	260.81	293.41	326.01	358.61	391.21	423.81	456.41	489.01	521.61	554.21	586.81	619.41	652.02	684.62	717.22	749.82	782.42
21	171.15	205.38	239.62	273.85	308.08	342.31	376.54	410.77	445.00	479.23	513.46	547.69	581.92	616.15	650.39	684.62	718.85	753.08	787.31	821.54
22	179.30	215.17	251.03	286.89	322.75	358.61	394.47	430.33	466.19	502.05	537.91	573.77	609.63	645.50	681.36	717.22	753.08	788.94	824.80	860.66
23	187.45	224.95	262.44	299.93	337.42	374.91	412.40	449.89	487.38	524.87	562.36	599.85	637.35	674.84	712.33	749.82	787.31	824.80	862.29	899.78
24	195.60	234.73	273.85	312.97	352.09	391.21	430.33	469.45	508.57	547.69	586.81	625.93	665.06	704.18	743.30	782.42	821.54	860.66	899.78	938.90
25	203.75	244.51	285.26	326.01	366.76	407.51	448.26	489.01	529.76	570.51	611.26	652.02	692.77	733.52	774.27	815.02	855.77	896.52	937.27	978.02
26	211.91	254.29	296.67	339.05	381.43	423.81	466.19	508.57	550.95	593.33	635.72	678.10	720.48	762.86	805.24	847.62	890.00	932.38	974.76	1,017.14
27	220.06	264.07	308.08	352.09	396.10	440.11	484.12	528.13	572.14	616.15	660.17	704.18	748.19	792.20	836.21	880.22	924.23	968.24	1,012.25	1,056.27
28	228.21	273.85	319.49	365.13	410.77	456.41	502.05	547.69	593.33	638.98	684.62	730.26	775.90	821.54	867.18	912.82	958.46	1,004.10	1,049.74	1,095.39
29	236.36	283.63	330.90	378.17	425.44	472.71	519.98	567.25	614.52	661.80	709.07	756.34	803.61	850.88	898.15	945.42	992.69	1,039.96	1,087.24	1,134.51
30*	244.51	293.41	342.31	391.21	440.11	489.01	537.91	586.81	635.72	684.62	733.52	782.42	831.32	880.22	929.12	978.02	1,026.92	1,075.83	1,124.73	1,173.63

**LOGOS SMALLER THAN 10" X 10" CAN BE PRICED AS A LETTER USING THE MAXIMUM DIMENSION**  
**LOGOS LARGER THAN SIZES SHOWN OR CONTAINING 31+ PIECES/CUTOUTS**  
**EMAIL: [Signage@GeminiMade.com](mailto:Signage@GeminiMade.com)**

## Aluminum Finishes

— Price as Listed —



Brushed Painted

**CLICK HERE TO VIEW  
STANDARD PAINTED  
COLORS**

— Add 25%- Brushed Anodized —

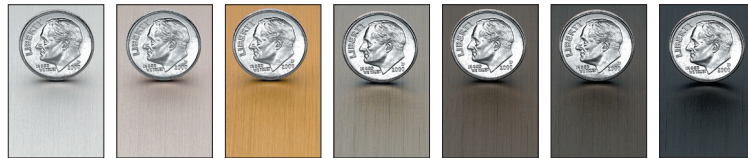

Clear Champagne Gold Light Bronze Medium Bronze Dark Bronze Black

— Add 30% —

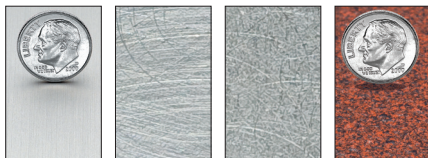

#4 Brushed Random Arc Orbital Rust Powdercoat

— Add 50% —

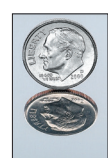

Polished

— Add 75%- Polished Anodized —



Clear Champagne Gold Light Bronze Medium Bronze Dark Bronze Black



# 1/2" Thick Brushed or Painted Aluminum Logos

PRICE PER LOGO. Including standard mounting with pattern.

Size	10"	12"	14"	16"	18"	20"	22"	24"	26"	28"	30"*	32"*	34"*	36"*	38"*	40"*	42"*	44"*	46"*	48"*
10"	\$107.53	\$129.04	\$150.54	\$172.05	\$193.55	\$215.06	\$236.57	\$258.07	\$279.58	\$301.08	\$322.59	\$344.10	\$365.60	\$387.11	\$408.61	\$430.12	\$451.63	\$473.13	\$494.64	\$516.14
11	118.28	141.94	165.60	189.25	212.91	236.57	260.22	283.88	307.54	331.19	354.85	378.51	402.16	425.82	449.48	473.13	496.79	520.45	544.10	567.76
12	129.04	154.84	180.65	206.46	232.26	258.07	283.88	309.69	335.49	361.30	387.11	412.92	438.72	464.53	490.34	516.14	541.95	567.76	593.57	619.37
13	139.79	167.75	195.70	223.66	251.62	279.58	307.54	335.49	363.45	391.41	419.37	447.32	475.28	503.24	531.20	559.16	587.11	615.07	643.03	670.99
14	150.54	180.65	210.76	240.87	270.98	301.08	331.19	361.30	391.41	421.52	451.63	481.73	511.84	541.95	572.06	602.17	632.28	662.38	692.49	722.60
15	161.30	193.55	225.81	258.07	290.33	322.59	354.85	387.11	419.37	451.63	483.89	516.14	548.40	580.66	612.92	645.18	677.44	709.70	741.96	774.22
16	172.05	206.46	240.87	275.28	309.69	344.10	378.51	412.92	447.32	481.73	516.14	550.55	584.96	619.37	653.78	688.19	722.60	757.01	791.42	825.83
17	182.80	219.36	255.92	292.48	329.04	365.60	402.16	438.72	475.28	511.84	548.40	584.96	621.52	658.08	694.64	731.20	767.76	804.32	840.88	877.44
18	193.55	232.26	270.98	309.69	348.40	387.11	425.82	464.53	503.24	541.95	580.66	619.37	658.08	696.79	735.51	774.22	812.93	851.64	890.35	929.06
19	204.31	245.17	286.03	326.89	367.75	408.61	449.48	490.34	531.20	572.06	612.92	653.78	694.64	735.51	776.37	817.23	858.09	898.95	939.81	980.67
20	215.06	258.07	301.08	344.10	387.11	430.12	473.13	516.14	559.16	602.17	645.18	688.19	731.20	774.22	817.23	860.24	903.25	946.26	989.28	1,032.29
21	225.81	270.98	316.14	361.30	406.46	451.63	496.79	541.95	587.11	632.28	677.44	722.60	767.76	812.93	858.09	903.25	948.41	993.58	1,038.74	1,083.90
22	236.57	283.88	331.19	378.51	425.82	473.13	520.45	567.76	615.07	662.38	709.70	757.01	804.32	851.64	898.95	946.26	993.58	1,040.89	1,088.20	1,135.52
23	247.32	296.78	346.25	395.71	445.17	494.64	544.10	593.57	643.03	692.49	741.96	791.42	840.88	890.35	939.81	989.28	1,038.74	1,088.20	1,137.67	1,187.13
24	258.07	309.69	361.30	412.92	464.53	516.14	567.76	619.37	670.99	722.60	774.22	825.83	877.44	929.06	980.67	1,032.29	1,083.90	1,135.52	1,187.13	1,238.75
25	268.83	322.59	376.36	430.12	483.89	537.65	591.42	645.18	698.95	752.71	806.48	860.24	914.01	967.77	1,021.54	1,075.30	1,129.07	1,182.83	1,236.60	1,290.36
26	279.58	335.49	391.41	447.32	503.24	559.16	615.07	670.99	726.90	782.82	838.73	894.65	950.57	1,006.48	1,062.40	1,118.31	1,174.23	1,230.14	1,286.06	1,341.97
27	290.33	348.40	406.46	464.53	522.60	580.66	638.73	696.79	754.86	812.93	870.99	929.06	987.13	1,045.19	1,103.26	1,161.32	1,219.39	1,277.46	1,335.52	1,393.59
28	301.08	361.30	421.52	481.73	541.95	602.17	662.38	722.60	782.82	843.04	903.25	963.47	1,023.69	1,083.90	1,144.12	1,204.34	1,264.55	1,324.77	1,384.99	1,445.20
29	311.84	374.20	436.57	498.94	561.31	623.67	686.04	748.41	810.78	873.14	935.51	997.88	1,060.25	1,122.61	1,184.98	1,247.35	1,309.72	1,372.08	1,434.45	1,496.82
30*	322.59	387.11	451.63	516.14	580.66	645.18	709.70	774.22	838.73	903.25	967.77	1,032.29	1,096.81	1,161.32	1,225.84	1,290.36	1,354.88	1,419.40	1,483.91	1,548.43

**LOGOS SMALLER THAN 10" X 10" CAN BE PRICED AS A LETTER USING THE MAXIMUM DIMENSION**  
**LOGOS LARGER THAN SIZES SHOWN OR CONTAINING 31+ PIECES/CUTOUTS**  
**EMAIL: [Signage@GeminiMade.com](mailto:Signage@GeminiMade.com)**

## Aluminum Finishes

— Price as Listed —



**CLICK HERE TO VIEW  
STANDARD PAINTED  
COLORS**

— Add 25% - Brushed Anodized —



— Add 30% —

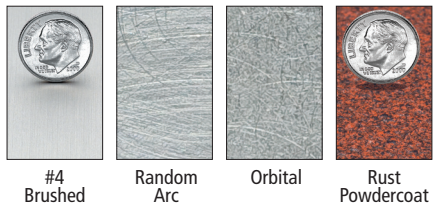

— Add 50% —

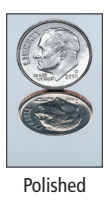

— Add 75% - Polished Anodized —



# 3/4" Thick Brushed or Painted Aluminum Logos

**PRICE PER LOGO.** Including standard mounting with pattern.

Size	10"	12"	14"	16"	18"	20"	22"	24"	26"	28"	30"*	32"*	34"*	36"*	38"*	40"*	42"*	44"*	46"*	48"*
10"	\$162.24	\$194.69	\$227.13	\$259.58	\$292.03	\$324.48	\$356.93	\$389.37	\$421.82	\$454.27	\$486.72	\$519.16	\$551.61	\$584.06	\$616.51	\$648.96	\$681.40	\$713.85	\$746.30	\$778.75
11	178.46	214.16	249.85	285.54	321.23	356.93	392.62	428.31	464.00	499.70	535.39	571.08	606.77	642.47	678.16	713.85	749.54	785.24	820.93	856.62
12	194.69	233.62	272.56	311.50	350.44	389.37	428.31	467.25	506.19	545.12	584.06	623.00	661.93	700.87	739.81	778.75	817.68	856.62	895.56	934.50
13	210.91	253.09	295.27	337.46	379.64	421.82	464.00	506.19	548.37	590.55	632.73	674.91	717.10	759.28	801.46	843.64	885.82	928.01	970.19	1,012.37
14	227.13	272.56	317.99	363.41	408.84	454.27	499.70	545.12	590.55	635.98	681.40	726.83	772.26	817.68	863.11	908.54	953.96	999.39	1,044.82	1,090.24
15	243.36	292.03	340.70	389.37	438.04	486.72	535.39	584.06	632.73	681.40	730.07	778.75	827.42	876.09	924.76	973.43	1,022.10	1,070.78	1,119.45	1,168.12
16	259.58	311.50	363.41	415.33	467.25	519.16	571.08	623.00	674.91	726.83	778.75	830.66	882.58	934.50	986.41	1,038.33	1,090.24	1,142.16	1,194.08	1,245.99
17	275.81	330.97	386.13	441.29	496.45	551.61	606.77	661.93	717.10	772.26	827.42	882.58	937.74	992.90	1,048.06	1,103.22	1,158.39	1,213.55	1,268.71	1,323.87
18	292.03	350.44	408.84	467.25	525.65	584.06	642.47	700.87	759.28	817.68	876.09	934.50	992.90	1,051.31	1,109.71	1,168.12	1,226.53	1,284.93	1,343.34	1,401.74
19	308.25	369.90	431.56	493.21	554.86	616.51	678.16	739.81	801.46	863.11	924.76	986.41	1,048.06	1,109.71	1,171.36	1,233.02	1,294.67	1,356.32	1,417.97	1,479.62
20	324.48	389.37	454.27	519.16	584.06	648.96	713.85	778.75	843.64	908.54	973.43	1,038.33	1,103.22	1,168.12	1,233.02	1,297.91	1,362.81	1,427.70	1,492.60	1,557.49
21	340.70	408.84	476.98	545.12	613.26	681.40	749.54	817.68	885.82	953.96	1,022.10	1,090.24	1,158.39	1,226.53	1,294.67	1,362.81	1,430.95	1,499.09	1,567.23	1,635.37
22	356.93	428.31	499.70	571.08	642.47	713.85	785.24	856.62	928.01	999.39	1,070.78	1,142.16	1,213.55	1,284.93	1,356.32	1,427.70	1,499.09	1,570.47	1,641.86	1,713.24
23	373.15	447.78	522.41	597.04	671.67	746.30	820.93	895.56	970.19	1,044.82	1,119.45	1,194.08	1,268.71	1,343.34	1,417.97	1,492.60	1,567.23	1,641.86	1,716.49	1,791.12
24	389.37	467.25	545.12	623.00	700.87	778.75	856.62	934.50	1,012.37	1,090.24	1,168.12	1,245.99	1,323.87	1,401.74	1,479.62	1,557.49	1,635.37	1,713.24	1,791.12	1,868.99
25	405.60	486.72	567.84	648.96	730.07	811.19	892.31	973.43	1,054.55	1,135.67	1,216.79	1,297.91	1,379.03	1,460.15	1,541.27	1,622.39	1,703.51	1,784.63	1,865.75	1,946.87
26	421.82	506.19	590.55	674.91	759.28	843.64	928.01	1,012.37	1,096.73	1,181.10	1,265.46	1,349.83	1,434.19	1,518.56	1,602.92	1,687.28	1,771.65	1,856.01	1,940.38	2,024.74
27	438.04	525.65	613.26	700.87	788.48	876.09	963.70	1,051.31	1,138.92	1,226.53	1,314.13	1,401.74	1,489.35	1,576.96	1,664.57	1,752.18	1,839.79	1,927.40	2,015.01	2,102.62
28	454.27	545.12	635.98	726.83	817.68	908.54	999.39	1,090.24	1,181.10	1,271.95	1,362.81	1,453.66	1,544.51	1,635.37	1,726.22	1,817.07	1,907.93	1,998.78	2,089.64	2,180.49
29	470.49	564.59	658.69	752.79	846.89	940.99	1,035.08	1,129.18	1,223.28	1,317.38	1,411.48	1,505.58	1,599.67	1,693.77	1,787.87	1,881.97	1,976.07	2,070.17	2,164.27	2,258.36
30*	486.72	584.06	681.40	778.75	876.09	973.43	1,070.78	1,168.12	1,265.46	1,362.81	1,460.15	1,557.49	1,654.84	1,752.18	1,849.52	1,946.87	2,044.21	2,141.55	2,238.90	2,336.24

**LOGOS SMALLER THAN 10" X 10" CAN BE PRICED AS A LETTER USING THE MAXIMUM DIMENSION**  
**LOGOS LARGER THAN SIZES SHOWN OR CONTAINING 31+ PIECES/CUTOUTS**  
**EMAIL: [Signage@GeminiMade.com](mailto:Signage@GeminiMade.com)**

## Aluminum Finishes

— Price as Listed —



Brushed Painted

**CLICK HERE TO VIEW  
STANDARD PAINTED  
COLORS**

— Add 25% - Brushed Anodized —

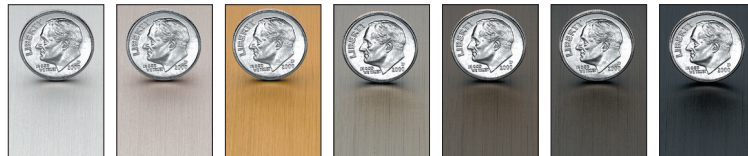

Clear Champagne Gold Light Bronze Medium Bronze Dark Bronze Black

— Add 30% —

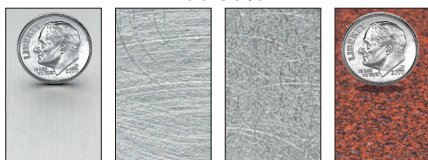

#4 Brushed Random Arc Orbital Rust Powdercoat

— Add 50% —

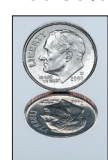

Polished

— Add 75% - Polished Anodized —

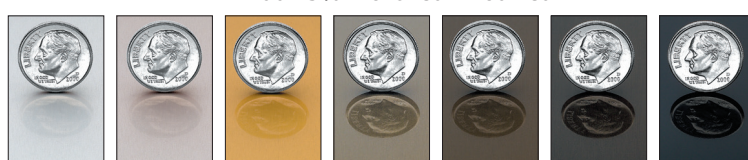

Clear Champagne Gold Light Bronze Medium Bronze Dark Bronze Black

# 1" Thick Brushed or Painted Aluminum Logos

PRICE PER LOGO. Including standard mounting with pattern.

Size	10"	12"	14"	16"	18"	20"	22"	24"	26"	28"	30"*	32"*	34"*	36"*	38"*	40"*	42"*	44"*	46"*	48"*
10"	\$211.93	\$254.32	\$296.71	\$339.09	\$381.48	\$423.87	\$466.25	\$508.64	\$551.03	\$593.41	\$635.80	\$678.19	\$720.57	\$762.96	\$805.34	\$847.73	\$890.12	\$932.50	\$974.89	\$1,017.28
11	233.13	279.75	326.38	373.00	419.63	466.25	512.88	559.50	606.13	652.75	699.38	746.00	792.63	839.25	885.88	932.50	979.13	1,025.76	1,072.38	1,119.01
12	254.32	305.18	356.05	406.91	457.78	508.64	559.50	610.37	661.23	712.09	762.96	813.82	864.69	915.55	966.41	1,017.28	1,068.14	1,119.01	1,169.87	1,220.73
13	275.51	330.62	385.72	440.82	495.92	551.03	606.13	661.23	716.33	771.44	826.54	881.64	936.74	991.85	1,046.95	1,102.05	1,157.15	1,212.26	1,267.36	1,322.46
14	296.71	356.05	415.39	474.73	534.07	593.41	652.75	712.09	771.44	830.78	890.12	949.46	1,008.80	1,068.14	1,127.48	1,186.82	1,246.17	1,305.51	1,364.85	1,424.19
15	317.90	381.48	445.06	508.64	572.22	635.80	699.38	762.96	826.54	890.12	953.70	1,017.28	1,080.86	1,144.44	1,208.02	1,271.60	1,335.18	1,398.76	1,462.34	1,525.92
16	339.09	406.91	474.73	542.55	610.37	678.19	746.00	813.82	881.64	949.46	1,017.28	1,085.10	1,152.91	1,220.73	1,288.55	1,356.37	1,424.19	1,492.01	1,559.83	1,627.64
17	360.29	432.34	504.40	576.46	648.51	720.57	792.63	864.69	936.74	1,008.80	1,080.86	1,152.91	1,224.97	1,297.03	1,369.09	1,441.14	1,513.20	1,585.26	1,657.32	1,729.37
18	381.48	457.78	534.07	610.37	686.66	762.96	839.25	915.55	991.85	1,068.14	1,144.44	1,220.73	1,297.03	1,373.33	1,449.62	1,525.92	1,602.21	1,678.51	1,754.80	1,831.10
19	402.67	483.21	563.74	644.28	724.81	805.34	885.88	966.41	1,046.95	1,127.48	1,208.02	1,288.55	1,369.09	1,449.62	1,530.16	1,610.69	1,691.22	1,771.76	1,852.29	1,932.83
20	423.87	508.64	593.41	678.19	762.96	847.73	932.50	1,017.28	1,102.05	1,186.82	1,271.60	1,356.37	1,441.14	1,525.92	1,610.69	1,695.46	1,780.24	1,865.01	1,949.78	2,034.56
21	445.06	534.07	623.08	712.09	801.11	890.12	979.13	1,068.14	1,157.15	1,246.17	1,335.18	1,424.19	1,513.20	1,602.21	1,691.22	1,780.24	1,869.25	1,958.26	2,047.27	2,136.28
22	466.25	559.50	652.75	746.00	839.25	932.50	1,025.76	1,119.01	1,212.26	1,305.51	1,398.76	1,492.01	1,585.26	1,678.51	1,771.76	1,865.01	1,958.26	2,051.51	2,144.76	2,238.01
23	487.45	584.93	682.42	779.91	877.40	974.89	1,072.38	1,169.87	1,267.36	1,364.85	1,462.34	1,559.83	1,657.32	1,754.80	1,852.29	1,949.78	2,047.27	2,144.76	2,242.25	2,339.74
24	508.64	610.37	712.09	813.82	915.55	1,017.28	1,119.01	1,220.73	1,322.46	1,424.19	1,525.92	1,627.64	1,729.37	1,831.10	1,932.83	2,034.56	2,136.28	2,238.01	2,339.74	2,441.47
25	529.83	635.80	741.77	847.73	953.70	1,059.66	1,165.63	1,271.60	1,377.56	1,483.53	1,589.50	1,695.46	1,801.43	1,907.40	2,013.36	2,119.33	2,225.30	2,331.26	2,437.23	2,543.19
26	551.03	661.23	771.44	881.64	991.85	1,102.05	1,212.26	1,322.46	1,432.67	1,542.87	1,653.08	1,763.28	1,873.49	1,983.69	2,093.90	2,204.10	2,314.31	2,424.51	2,534.72	2,644.92
27	572.22	686.66	801.11	915.55	1,029.99	1,144.44	1,258.88	1,373.33	1,487.77	1,602.21	1,716.66	1,831.10	1,945.54	2,059.99	2,174.43	2,288.88	2,403.32	2,517.76	2,632.21	2,746.65
28	593.41	712.09	830.78	949.46	1,068.14	1,186.82	1,305.51	1,424.19	1,542.87	1,661.55	1,780.24	1,898.92	2,017.60	2,136.28	2,254.97	2,373.65	2,492.33	2,611.01	2,729.70	2,848.38
29	614.61	737.53	860.45	983.37	1,106.29	1,229.21	1,352.13	1,475.05	1,597.97	1,720.89	1,843.82	1,966.74	2,089.66	2,212.58	2,335.50	2,458.42	2,581.34	2,704.26	2,827.18	2,950.11
30*	635.80	762.96	890.12	1,017.28	1,144.44	1,271.60	1,398.76	1,525.92	1,653.08	1,780.24	1,907.40	2,034.56	2,161.72	2,288.88	2,416.03	2,543.19	2,670.35	2,797.51	2,924.67	3,051.83

**LOGOS SMALLER THAN 10" X 10" CAN BE PRICED AS A LETTER USING THE MAXIMUM DIMENSION**  
**LOGOS LARGER THAN SIZES SHOWN OR CONTAINING 31+ PIECES/CUTOUTS**  
**EMAIL: [Signage@GeminiMade.com](mailto:Signage@GeminiMade.com)**

## Aluminum Finishes

— Price as Listed —



**CLICK HERE TO VIEW  
STANDARD PAINTED  
COLORS**

— Add 25% - Brushed Anodized —



— Add 30% —

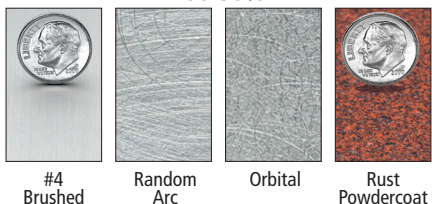

— Add 50% —

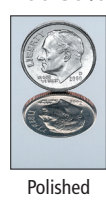

— Add 75% - Polished Anodized —





# 1/8" & 1/4" Thick Stainless Steel Letters

**PRICE PER LETTER** Including standard mounting with pattern.

☐ Plain Mount Only

	1/8" THICK					1/4" THICK				
	304 Brushed	304 Polished	Cor-Ten®	316 Brushed	316 Polished	304 Brushed	304 Polished	Cor-Ten®	316 Brushed	316 Polished
1" †	\$21.50	---	\$15.05	\$27.95	---	---	---	---	---	---
2	26.20	---	18.34	34.06	---	\$30.90	\$40.17	\$21.63	\$40.17	\$49.44
3	29.80	\$38.74	20.86	38.74	\$47.68	35.70	46.41	24.99	46.41	57.12
4	40.50	52.65	28.35	52.65	64.80	44.10	57.33	30.87	57.33	70.56
5	48.80	63.44	34.16	63.44	78.08	52.40	68.12	36.68	68.12	83.84
6	59.40	77.22	41.58	77.22	95.04	60.70	78.91	42.49	78.91	97.12
7	71.30	92.69	49.91	92.69	114.08	73.70	95.81	51.59	95.81	117.92
8	78.50	102.05	54.95	102.05	125.60	84.50	109.85	59.15	109.85	135.20
9	88.00	114.40	61.60	114.40	140.80	95.10	123.63	66.57	123.63	152.16
10	97.50	126.75	68.25	126.75	156.00	104.70	136.11	73.29	136.11	167.52
11	105.80	137.54	74.06	137.54	169.28	118.90	154.57	83.23	154.57	190.24
12	123.70	160.81	86.59	160.81	197.92	133.20	173.16	93.24	173.16	213.12
13	139.20	180.96	97.44	180.96	222.72	146.20	190.06	102.34	190.06	233.92
14	154.50	200.85	108.15	200.85	247.20	160.50	208.65	112.35	208.65	256.80
15	168.80	219.44	118.16	219.44	270.08	176.00	228.80	123.20	228.80	281.60
16	193.70	251.81	135.59	251.81	309.92	200.90	261.17	140.63	261.17	321.44
17	209.20	271.96	146.44	271.96	334.72	225.80	293.54	158.06	293.54	361.28
18	229.40	298.22	160.58	298.22	367.04	253.20	329.16	177.24	329.16	405.12
19	249.60	324.48	174.72	324.48	399.36	278.20	361.66	194.74	361.66	445.12
20	271.10	352.43	189.77	352.43	433.76	307.90	400.27	215.53	400.27	492.64
21	293.70	381.81	205.59	381.81	469.92	336.40	437.32	235.48	437.32	538.24
22	325.70	423.41	227.99	423.41	521.12	367.30	477.49	257.11	477.49	587.68
23	351.80	457.34	246.26	457.34	562.88	399.40	519.22	279.58	519.22	639.04
24	381.60	496.08	267.12	496.08	610.56	432.70	562.51	302.89	562.51	692.32
25	406.50	528.45	284.55	528.45	650.40	452.90	588.77	317.03	588.77	724.64
26	435.00	565.50	304.50	565.50	696.00	471.90	613.47	330.33	613.47	755.04
27	461.20	599.56	322.84	599.56	737.92	493.30	641.29	345.31	641.29	789.28
28	488.60	635.18	342.02	635.18	781.76	511.10	664.43	357.77	664.43	817.76
29	513.50	667.55	359.45	667.55	821.60	532.50	692.25	372.75	692.25	852.00
30*	539.70	701.61	377.79	701.61	863.52	552.70	718.51	386.89	718.51	884.32
31*	577.60	750.88	404.32	750.88	924.16	582.40	757.12	407.68	757.12	931.84
32*	602.70	783.51	421.89	783.51	964.32	626.50	814.45	438.55	814.45	1,002.40
33*	626.50	814.45	438.55	814.45	1,002.40	670.40	871.52	469.28	871.52	1,072.64
34*	653.70	849.81	457.59	849.81	1,045.92	713.10	927.03	499.17	927.03	1,140.96
35*	677.50	880.75	474.25	880.75	1,084.00	755.90	982.67	529.13	982.67	1,209.44
36*	701.20	911.56	490.84	911.56	1,121.92	799.90	1,039.87	559.93	1,039.87	1,279.84
37"+	EMAIL FOR QUOTE									

LETTER HEIGHT - MAX DIMENSION

† 1" Letters UPPER CASE ONLY.

## 304 Stainless Steel



Brushed



Polished

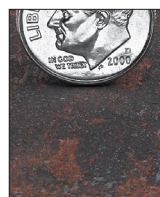

Cor-Ten®



Brushed



Polished

## 304 Stainless Steel

### Additional Pricing Notes:

- Price includes either plain or stud mount and installation pattern / stencil
- Lower case is 75% of the corresponding Upper Case price
- Small punctuation, such as a comma, period and dash are 33% of the Upper Case price

### 3/8" & 1/2" Thick Stainless Steel Letters

PRICE PER LETTER Including standard mounting with pattern.

	3/8" THICK				1/2" THICK			
	304 Brushed	304 Polished	316 Brushed	316 Polished	304 Brushed	304 Polished	316 Brushed	316 Polished
2"	\$42.80	\$55.64	\$55.64	\$68.48	\$59.40	\$77.22	\$77.22	\$95.04
3	46.40	60.32	60.32	74.24	66.60	86.58	86.58	106.56
4	60.70	78.91	78.91	97.12	85.60	111.28	111.28	136.96
5	70.20	91.26	91.26	112.32	97.50	126.75	126.75	156.00
6	82.00	106.60	106.60	131.20	113.00	146.90	146.90	180.80
7	96.40	125.32	125.32	154.24	130.70	169.91	169.91	209.12
8	105.80	137.54	137.54	169.28	152.20	197.86	197.86	243.52
9	120.10	156.13	156.13	192.16	172.40	224.12	224.12	275.84
10	135.60	176.28	176.28	216.96	192.60	250.38	250.38	308.16
11	151.00	196.30	196.30	241.60	216.40	281.32	281.32	346.24
12	170.00	221.00	221.00	272.00	237.70	309.01	309.01	380.32
13	185.40	241.02	241.02	296.64	265.10	344.63	344.63	424.16
14	204.50	265.85	265.85	327.20	291.30	378.69	378.56	465.92
15	224.70	292.11	292.11	359.52	320.90	417.17	417.17	513.44
16	248.40	322.92	322.92	397.44	351.80	457.34	457.34	562.88
17	269.90	350.87	350.87	431.84	392.20	509.86	509.86	627.52
18	292.40	380.12	380.12	467.84	430.30	559.39	559.39	688.48
19	317.40	412.62	412.62	507.84	461.20	599.56	599.56	737.92
20	342.40	445.12	445.12	547.84	499.20	648.96	648.96	798.72
21	368.40	478.92	478.92	589.44	536.10	696.93	696.93	857.76
22	395.80	514.54	514.54	633.28	577.70	751.01	750.88	924.16
23	423.10	550.03	550.03	676.96	616.90	801.97	801.97	987.04
24	451.60	587.08	587.08	722.56	658.50	856.05	856.05	1,053.60
25	487.30	633.49	633.49	779.68	707.20	919.36	919.36	1,131.52
26	518.20	673.66	673.66	829.12	754.80	981.24	981.24	1,207.68
27	551.60	717.08	717.08	882.56	802.30	1,042.99	1,042.99	1,283.68
28	582.40	757.12	757.12	931.84	846.30	1,100.19	1,100.19	1,354.08
29	614.60	798.98	798.98	983.36	892.70	1,160.51	1,160.51	1,428.32
30	645.40	839.02	839.02	1,032.64	941.40	1,223.82	1,223.82	1,506.24
31	716.70	931.71	931.71	1,146.72	1,035.30	1,345.89	1,345.89	1,656.48
32	788.00	1,024.40	1,024.40	1,260.80	1,126.80	1,464.84	1,464.84	1,802.88
33	858.20	1,115.66	1,115.66	1,373.12	1,215.90	1,580.67	1,580.67	1,945.44
34	929.50	1,208.35	1,208.35	1,487.20	1,309.80	1,702.74	1,702.74	2,095.68
35	998.40	1,297.92	1,297.92	1,597.44	1,402.50	1,823.25	1,823.25	2,244.00
36	1,069.70	1,390.61	1,390.61	1,711.52	1,490.50	1,937.65	1,937.65	2,384.80
37"+	EMAIL FOR QUOTE							

LETTER HEIGHT - MAX DIMENSION

### 304 Stainless Steel



Brushed



Polished

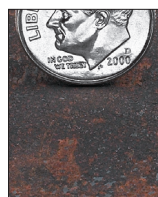

Cor-Ten®

### 304 Stainless Steel



Brushed

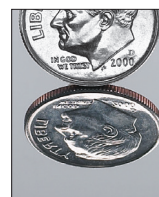

Polished

#### Additional Pricing Notes:

- Price includes either plain or stud mount and installation pattern / stencil
- Lower case is 75% of the corresponding Upper Case price
- Small punctuation, such as a comma, period and dash are 33% of the Upper Case price

# 1/8" Thick Brushed 304 Stainless Steel Logos

**PRICE PER LOGO. Including standard mounting with pattern.**

Size	10"	12"	14"	16"	18"	20"	22"	24"	26"	28"	30"*	32"*	34"*	36"*	38"*	40"*	42"*	44"*	46"*	48"*
10"	\$95.35	\$114.42	\$133.49	\$152.56	\$171.63	\$190.70	\$209.76	\$228.83	\$247.90	\$266.97	\$286.04	\$305.11	\$324.18	\$343.25	\$362.32	\$381.39	\$400.46	\$419.53	\$438.60	\$457.67
11	104.88	125.86	146.84	167.81	188.79	209.76	230.74	251.72	272.69	293.67	314.65	335.62	356.60	377.58	398.55	419.53	440.51	461.48	482.46	503.44
12	114.42	137.30	160.18	183.07	205.95	228.83	251.72	274.60	297.48	320.37	343.25	366.14	389.02	411.90	434.79	457.67	480.55	503.44	526.32	549.20
13	123.95	148.74	173.53	198.32	223.11	247.90	272.69	297.48	322.28	347.07	371.86	396.65	421.44	446.23	471.02	495.81	520.60	545.39	570.18	594.97
14	133.49	160.18	186.88	213.58	240.28	266.97	293.67	320.37	347.07	373.76	400.46	427.16	453.85	480.55	507.25	533.95	560.64	587.34	614.04	640.74
15	143.02	171.63	200.23	228.83	257.44	286.04	314.65	343.25	371.86	400.46	429.06	457.67	486.27	514.88	543.48	572.09	600.69	629.29	657.90	686.50
16	152.56	183.07	213.58	244.09	274.60	305.11	335.62	366.14	396.65	427.16	457.67	488.18	518.69	549.20	579.71	610.23	640.74	671.25	701.76	732.27
17	162.09	194.51	226.93	259.35	291.76	324.18	356.60	389.02	421.44	453.85	486.27	518.69	551.11	583.53	615.95	648.36	680.78	713.20	745.62	778.04
18	171.63	205.95	240.28	274.60	308.93	343.25	377.58	411.90	446.23	480.55	514.88	549.20	583.53	617.85	652.18	686.50	720.83	755.15	789.48	823.80
19	181.16	217.39	253.62	289.86	326.09	362.32	398.55	434.79	471.02	507.25	543.48	579.71	615.95	652.18	688.41	724.64	760.87	797.11	833.34	869.57
20	190.70	228.83	266.97	305.11	343.25	381.39	419.53	457.67	495.81	533.95	572.09	610.23	648.36	686.50	724.64	762.78	800.92	839.06	877.20	915.34
21	200.23	240.28	280.32	320.37	360.41	400.46	440.51	480.55	520.60	560.64	600.69	640.74	680.78	720.83	760.87	800.92	840.97	881.01	921.06	961.10
22	209.76	251.72	293.67	335.62	377.58	419.53	461.48	503.44	545.39	587.34	629.29	671.25	713.20	755.15	797.11	839.06	881.01	922.97	964.92	1,006.87
23	219.30	263.16	307.02	350.88	394.74	438.60	482.46	526.32	570.18	614.04	657.90	701.76	745.62	789.48	833.34	877.20	921.06	964.92	1,008.78	1,052.64
24	228.83	274.60	320.37	366.14	411.90	457.67	503.44	549.20	594.97	640.74	686.50	732.27	778.04	823.80	869.57	915.34	961.10	1,006.87	1,052.64	1,098.41
25	238.37	286.04	333.72	381.39	429.06	476.74	524.41	572.09	619.76	667.43	715.11	762.78	810.46	858.13	905.80	953.48	1,001.15	1,048.82	1,096.50	1,144.17
26	247.90	297.48	347.07	396.65	446.23	495.81	545.39	594.97	644.55	694.13	743.71	793.29	842.87	892.45	942.03	991.62	1,041.20	1,090.78	1,140.36	1,189.94
27	257.44	308.93	360.41	411.90	463.39	514.88	566.37	617.85	669.34	720.83	772.32	823.80	875.29	926.78	978.27	1,029.75	1,081.24	1,132.73	1,184.22	1,235.71
28	266.97	320.37	373.76	427.16	480.55	533.95	587.34	640.74	694.13	747.53	800.92	854.32	907.71	961.10	1,014.50	1,067.89	1,121.29	1,174.68	1,228.08	1,281.47
29	276.51	331.81	387.11	442.41	497.71	553.02	608.32	663.62	718.92	774.22	829.52	884.83	940.13	995.43	1,050.73	1,106.03	1,161.33	1,216.64	1,271.94	1,327.24
30*	286.04	343.25	400.46	457.67	514.88	572.09	629.29	686.50	743.71	800.92	858.13	915.34	972.55	1,029.75	1,086.96	1,144.17	1,201.38	1,258.59	1,315.80	1,373.01

\*Oversize charges will apply

**LOGOS SMALLER THAN 10" X 10" CAN BE PRICED AS A LETTER USING THE MAXIMUM DIMENSION**  
**LOGOS LARGER THAN SIZES SHOWN OR CONTAINING 31+ PIECES/CUTOUTS**  
**EMAIL: [Signage@GeminiMade.com](mailto:Signage@GeminiMade.com)**

## 304 Stainless Steel

Price as Listed



Brushed

Add 30%



Polished

Less 30%

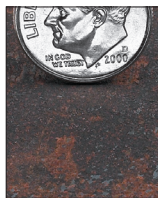

Cor-Ten®

## 316 Stainless Steel

Add 30%



Brushed

Add 60%



Polished



# 1/4" Thick Brushed 304 Stainless Steel Logos

**PRICE PER LOGO. Including standard mounting with pattern.**

Size	10"	12"	14"	16"	18"	20"	22"	24"	26"	28"	30"*	32"*	34"*	36"*	38"*	40"*	42"*	44"*	46"*	48"*
10"	\$111.83	\$134.19	\$156.56	\$178.92	\$201.29	\$223.65	\$246.02	\$268.38	\$290.75	\$313.11	\$335.48	\$357.84	\$380.21	\$402.57	\$424.94	\$447.30	\$469.67	\$492.03	\$514.40	\$536.76
11	123.01	147.61	172.21	196.81	221.41	246.02	270.62	295.22	319.82	344.42	369.02	393.63	418.23	442.83	467.43	492.03	516.63	541.24	565.84	590.44
12	134.19	161.03	187.87	214.70	241.54	268.38	295.22	322.06	348.90	375.73	402.57	429.41	456.25	483.09	509.92	536.76	563.60	590.44	617.28	644.11
13	145.37	174.45	203.52	232.60	261.67	290.75	319.82	348.90	377.97	407.04	436.12	465.19	494.27	523.34	552.42	581.49	610.57	639.64	668.72	697.79
14	156.56	187.87	219.18	250.49	281.80	313.11	344.42	375.73	407.04	438.36	469.67	500.98	532.29	563.60	594.91	626.22	657.53	688.85	720.16	751.47
15	167.74	201.29	234.83	268.38	301.93	335.48	369.02	402.57	436.12	469.67	503.21	536.76	570.31	603.86	637.41	670.95	704.50	738.05	771.60	805.14
16	178.92	214.70	250.49	286.27	322.06	357.84	393.63	429.41	465.19	500.98	536.76	572.55	608.33	644.11	679.90	715.68	751.47	787.25	823.04	858.82
17	190.10	228.12	266.14	304.17	342.19	380.21	418.23	456.25	494.27	532.29	570.31	608.33	646.35	684.37	722.39	760.41	798.43	836.45	874.48	912.50
18	201.29	241.54	281.80	322.06	362.31	402.57	442.83	483.09	523.34	563.60	603.86	644.11	684.37	724.63	764.89	805.14	845.40	885.66	925.92	966.17
19	212.47	254.96	297.46	339.95	382.44	424.94	467.43	509.92	552.42	594.91	637.41	679.90	722.39	764.89	807.38	849.87	892.37	934.86	977.36	1,019.85
20	223.65	268.38	313.11	357.84	402.57	447.30	492.03	536.76	581.49	626.22	670.95	715.68	760.41	805.14	849.87	894.60	939.33	984.06	1,028.79	1,073.52
21	234.83	281.80	328.77	375.73	422.70	469.67	516.63	563.60	610.57	657.53	704.50	751.47	798.43	845.40	892.37	939.33	986.30	1,033.27	1,080.23	1,127.20
22	246.02	295.22	344.42	393.63	442.83	492.03	541.24	590.44	639.64	688.85	738.05	787.25	836.45	885.66	934.86	984.06	1,033.27	1,082.47	1,131.67	1,180.88
23	257.20	308.64	360.08	411.52	462.96	514.40	565.84	617.28	668.72	720.16	771.60	823.04	874.48	925.92	977.36	1,028.79	1,080.23	1,131.67	1,183.11	1,234.55
24	268.38	322.06	375.73	429.41	483.09	536.76	590.44	644.11	697.79	751.47	805.14	858.82	912.50	966.17	1,019.85	1,073.52	1,127.20	1,180.88	1,234.55	1,288.23
25	279.56	335.48	391.39	447.30	503.21	559.13	615.04	670.95	726.87	782.78	838.69	894.60	950.52	1,006.43	1,062.34	1,118.26	1,174.17	1,230.08	1,285.99	1,341.91
26	290.75	348.90	407.04	465.19	523.34	581.49	639.64	697.79	755.94	814.09	872.24	930.39	988.54	1,046.69	1,104.84	1,162.99	1,221.13	1,279.28	1,337.43	1,395.58
27	301.93	362.31	422.70	483.09	543.47	603.86	664.24	724.63	785.02	845.40	905.79	966.17	1,026.56	1,086.94	1,147.33	1,207.72	1,268.10	1,328.49	1,388.87	1,449.26
28	313.11	375.73	438.36	500.98	563.60	626.22	688.85	751.47	814.09	876.71	939.33	1,001.96	1,064.58	1,127.20	1,189.82	1,252.45	1,315.07	1,377.69	1,440.31	1,502.93
29	324.29	389.15	454.01	518.87	583.73	648.59	713.45	778.31	843.16	908.02	972.88	1,037.74	1,102.60	1,167.46	1,232.32	1,297.18	1,362.03	1,426.89	1,491.75	1,556.61
30*	335.48	402.57	469.67	536.76	603.86	670.95	738.05	805.14	872.24	939.33	1,006.43	1,073.52	1,140.62	1,207.72	1,274.81	1,341.91	1,409.00	1,476.10	1,543.19	1,610.29

\*Oversize charges will apply

**LOGOS SMALLER THAN 10" X 10" CAN BE PRICED AS A LETTER USING THE MAXIMUM DIMENSION**  
**LOGOS LARGER THAN SIZES SHOWN OR CONTAINING 31+ PIECES/CUTOUTS**  
**EMAIL: [Signage@GeminiMade.com](mailto:Signage@GeminiMade.com)**

## 304 Stainless Steel

Price as Listed

Add 30%

Less 30%



Brushed



Polished

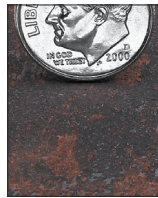

Cor-Ten®

## 316 Stainless Steel

Add 30%

Add 60%



Brushed



Polished

# 3/8" Thick Brushed 304 Stainless Steel Logos

**PRICE PER LOGO. Including standard mounting with pattern.**

Size	10"	12"	14"	16"	18"	20"	22"	24"	26"	28"	30"*	32"*	34"*	36"*	38"*	40"*	42"*	44"*	46"*	48"*
10"	\$143.08	\$171.70	\$200.32	\$228.94	\$257.55	\$286.17	\$314.79	\$343.40	\$372.02	\$400.64	\$429.25	\$457.87	\$486.49	\$515.11	\$543.72	\$572.34	\$600.96	\$629.57	\$658.19	\$686.81
11	157.39	188.87	220.35	251.83	283.31	314.79	346.27	377.74	409.22	440.70	472.18	503.66	535.14	566.62	598.10	629.57	661.05	692.53	724.01	755.49
12	171.70	206.04	240.38	274.72	309.06	343.40	377.74	412.08	446.43	480.77	515.11	549.45	583.79	618.13	652.47	686.81	721.15	755.49	789.83	824.17
13	186.01	223.21	260.41	297.62	334.82	372.02	409.22	446.43	483.63	520.83	558.03	595.23	632.44	669.64	706.84	744.04	781.24	818.45	855.65	892.85
14	200.32	240.38	280.45	320.51	360.57	400.64	440.70	480.77	520.83	560.89	600.96	641.02	681.08	721.15	761.21	801.28	841.34	881.40	921.47	961.53
15	214.63	257.55	300.48	343.40	386.33	429.25	472.18	515.11	558.03	600.96	643.88	686.81	729.73	772.66	815.58	858.51	901.44	944.36	987.29	1,030.21
16	228.94	274.72	320.51	366.30	412.08	457.87	503.66	549.45	595.23	641.02	686.81	732.60	778.38	824.17	869.96	915.74	961.53	1,007.32	1,053.11	1,098.89
17	243.24	291.89	340.54	389.19	437.84	486.49	535.14	583.79	632.44	681.08	729.73	778.38	827.03	875.68	924.33	972.98	1,021.63	1,070.28	1,118.92	1,167.57
18	257.55	309.06	360.57	412.08	463.60	515.11	566.62	618.13	669.64	721.15	772.66	824.17	875.68	927.19	978.70	1,030.21	1,081.72	1,133.23	1,184.74	1,236.25
19	271.86	326.23	380.61	434.98	489.35	543.72	598.10	652.47	706.84	761.21	815.58	869.96	924.33	978.70	1,033.07	1,087.45	1,141.82	1,196.19	1,250.56	1,304.93
20	286.17	343.40	400.64	457.87	515.11	572.34	629.57	686.81	744.04	801.28	858.51	915.74	972.98	1,030.21	1,087.45	1,144.68	1,201.91	1,259.15	1,316.38	1,373.62
21	300.48	360.57	420.67	480.77	540.86	600.96	661.05	721.15	781.24	841.34	901.44	961.53	1,021.63	1,081.72	1,141.82	1,201.91	1,262.01	1,322.11	1,382.20	1,442.30
22	314.79	377.74	440.70	503.66	566.62	629.57	692.53	755.49	818.45	881.40	944.36	1,007.32	1,070.28	1,133.23	1,196.19	1,259.15	1,322.11	1,385.06	1,448.02	1,510.98
23	329.10	394.91	460.73	526.55	592.37	658.19	724.01	789.83	855.65	921.47	987.29	1,053.11	1,118.92	1,184.74	1,250.56	1,316.38	1,382.20	1,448.02	1,513.84	1,579.66
24	343.40	412.08	480.77	549.45	618.13	686.81	755.49	824.17	892.85	961.53	1,030.21	1,098.89	1,167.57	1,236.25	1,304.93	1,373.62	1,442.30	1,510.98	1,579.66	1,648.34
25	357.71	429.25	500.80	572.34	643.88	715.42	786.97	858.51	930.05	1,001.59	1,073.14	1,144.68	1,216.22	1,287.76	1,359.31	1,430.85	1,502.39	1,573.93	1,645.48	1,717.02
26	372.02	446.43	520.83	595.23	669.64	744.04	818.45	892.85	967.25	1,041.66	1,116.06	1,190.47	1,264.87	1,339.28	1,413.68	1,488.08	1,562.49	1,636.89	1,711.30	1,785.70
27	386.33	463.60	540.86	618.13	695.39	772.66	849.92	927.19	1,004.46	1,081.72	1,158.99	1,236.25	1,313.52	1,390.79	1,468.05	1,545.32	1,622.58	1,699.85	1,777.12	1,854.38
28	400.64	480.77	560.89	641.02	721.15	801.28	881.40	961.53	1,041.66	1,121.79	1,201.91	1,282.04	1,362.17	1,442.30	1,522.42	1,602.55	1,682.68	1,762.81	1,842.93	1,923.06
29	414.95	497.94	580.92	663.91	746.90	829.89	912.88	995.87	1,078.86	1,161.85	1,244.84	1,327.83	1,410.82	1,493.81	1,576.80	1,659.79	1,742.77	1,825.76	1,908.75	1,991.74
30*	429.25	515.11	600.96	686.81	772.66	858.51	944.36	1,030.21	1,116.06	1,201.91	1,287.76	1,373.62	1,459.47	1,545.32	1,631.17	1,717.02	1,802.87	1,888.72	1,974.57	2,060.42

\*Oversize charges will apply

**LOGOS SMALLER THAN 10" X 10" CAN BE PRICED AS A LETTER USING THE MAXIMUM DIMENSION**  
**LOGOS LARGER THAN SIZES SHOWN OR CONTAINING 31+ PIECES/CUTOUTS**  
**EMAIL: [Signage@GeminiMade.com](mailto:Signage@GeminiMade.com)**

## 304 Stainless Steel

Price as Listed

Add 30%

Less 30%



Brushed



Polished

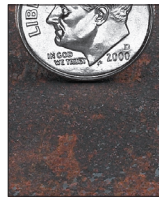

Cor-Ten®

## 316 Stainless Steel

Add 30%

Add 60%



Brushed



Polished

# 1/2" Thick Brushed 304 Stainless Steel Logos

**PRICE PER LOGO. Including standard mounting with pattern.**

Size	10"	12"	14"	16"	18"	20"	22"	24"	26"	28"	30"*	32"*	34"*	36"*	38"*	40"*	42"*	44"*	46"*	48"*
10"	\$185.36	\$222.44	\$259.51	\$296.58	\$333.66	\$370.73	\$407.80	\$444.87	\$481.95	\$519.02	\$556.09	\$593.17	\$630.24	\$667.31	\$704.38	\$741.46	\$778.53	\$815.60	\$852.68	\$889.75
11	203.90	244.68	285.46	326.24	367.02	407.80	448.58	489.36	530.14	570.92	611.70	652.48	693.26	734.04	774.82	815.60	856.38	897.16	937.94	978.72
12	222.44	266.92	311.41	355.90	400.39	444.87	489.36	533.85	578.34	622.82	667.31	711.80	756.29	800.77	845.26	889.75	934.24	978.72	1,023.21	1,067.70
13	240.97	289.17	337.36	385.56	433.75	481.95	530.14	578.34	626.53	674.73	722.92	771.12	819.31	867.50	915.70	963.89	1,012.09	1,060.28	1,108.48	1,156.67
14	259.51	311.41	363.31	415.22	467.12	519.02	570.92	622.82	674.73	726.63	778.53	830.43	882.33	934.24	986.14	1,038.04	1,089.94	1,141.84	1,193.75	1,245.65
15	278.05	333.66	389.26	444.87	500.48	556.09	611.70	667.31	722.92	778.53	834.14	889.75	945.36	1,000.97	1,056.58	1,112.19	1,167.79	1,223.40	1,279.01	1,334.62
16	296.58	355.90	415.22	474.53	533.85	593.17	652.48	711.80	771.12	830.43	889.75	949.07	1,008.38	1,067.70	1,127.01	1,186.33	1,245.65	1,304.96	1,364.28	1,423.60
17	315.12	378.14	441.17	504.19	567.21	630.24	693.26	756.29	819.31	882.33	945.36	1,008.38	1,071.41	1,134.43	1,197.45	1,260.48	1,323.50	1,386.52	1,449.55	1,512.57
18	333.66	400.39	467.12	533.85	600.58	667.31	734.04	800.77	867.50	934.24	1,000.97	1,067.70	1,134.43	1,201.16	1,267.89	1,334.62	1,401.35	1,468.08	1,534.82	1,601.55
19	352.19	422.63	493.07	563.51	633.95	704.38	774.82	845.26	915.70	986.14	1,056.58	1,127.01	1,197.45	1,267.89	1,338.33	1,408.77	1,479.21	1,549.65	1,620.08	1,690.52
20	370.73	444.87	519.02	593.17	667.31	741.46	815.60	889.75	963.89	1,038.04	1,112.19	1,186.33	1,260.48	1,334.62	1,408.77	1,482.91	1,557.06	1,631.21	1,705.35	1,779.50
21	389.26	467.12	544.97	622.82	700.68	778.53	856.38	934.24	1,012.09	1,089.94	1,167.79	1,245.65	1,323.50	1,401.35	1,479.21	1,557.06	1,634.91	1,712.77	1,790.62	1,868.47
22	407.80	489.36	570.92	652.48	734.04	815.60	897.16	978.72	1,060.28	1,141.84	1,223.40	1,304.96	1,386.52	1,468.08	1,549.65	1,631.21	1,712.77	1,794.33	1,875.89	1,957.45
23	426.34	511.61	596.87	682.14	767.41	852.68	937.94	1,023.21	1,108.48	1,193.75	1,279.01	1,364.28	1,449.55	1,534.82	1,620.08	1,705.35	1,790.62	1,875.89	1,961.15	2,046.42
24	444.87	533.85	622.82	711.80	800.77	889.75	978.72	1,067.70	1,156.67	1,245.65	1,334.62	1,423.60	1,512.57	1,601.55	1,690.52	1,779.50	1,868.47	1,957.45	2,046.42	2,135.40
25	463.41	556.09	648.77	741.46	834.14	926.82	1,019.50	1,112.19	1,204.87	1,297.55	1,390.23	1,482.91	1,575.60	1,668.28	1,760.96	1,853.64	1,946.32	2,039.01	2,131.69	2,224.37
26	481.95	578.34	674.73	771.12	867.50	963.89	1,060.28	1,156.67	1,253.06	1,349.45	1,445.84	1,542.23	1,638.62	1,735.01	1,831.40	1,927.79	2,024.18	2,120.57	2,216.96	2,313.35
27	500.48	600.58	700.68	800.77	900.87	1,000.97	1,101.06	1,201.16	1,301.26	1,401.35	1,501.45	1,601.55	1,701.64	1,801.74	1,901.84	2,001.93	2,102.03	2,202.13	2,302.22	2,402.32
28	519.02	622.82	726.63	830.43	934.24	1,038.04	1,141.84	1,245.65	1,349.45	1,453.26	1,557.06	1,660.86	1,764.67	1,868.47	1,972.28	2,076.08	2,179.88	2,283.69	2,387.49	2,491.30
29	537.56	645.07	752.58	860.09	967.60	1,075.11	1,182.62	1,290.14	1,397.65	1,505.16	1,612.67	1,720.18	1,827.69	1,935.20	2,042.71	2,150.23	2,257.74	2,365.25	2,472.76	2,580.27
30*	556.09	667.31	778.53	889.75	1,000.97	1,112.19	1,223.40	1,334.62	1,445.84	1,557.06	1,668.28	1,779.50	1,890.72	2,001.93	2,113.15	2,224.37	2,335.59	2,446.81	2,558.03	2,669.25

\*Oversize charges will apply

**LOGOS SMALLER THAN 10" X 10" CAN BE PRICED AS A LETTER USING THE MAXIMUM DIMENSION**  
**LOGOS LARGER THAN SIZES SHOWN OR CONTAINING 31+ PIECES/CUTOUTS**  
**EMAIL: [Signage@GeminiMade.com](mailto:Signage@GeminiMade.com)**

## 304 Stainless Steel

Price as Listed



Brushed

Add 30%



Polished

Less 30%

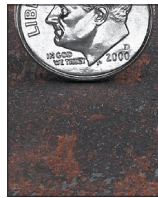

Cor-Ten®

## 316 Stainless Steel

Add 30%



Brushed

Add 60%



Polished



# 1/8", 1/4" & 3/8" Thick Brass & Bronze Letters

PRICE PER LETTER Including standard mounting with pattern.

Patina Only

	1/8" THICK			1/4" THICK			3/8" THICK		
	Brushed	Oxidized	Polished & Patina	Brushed	Oxidized	Polished & Patina	Brushed	Oxidized	Polished & Patina
1" †	\$25.60	\$29.44	\$33.28	\$26.70	\$30.71	\$34.71	---	---	---
2	30.30	34.85	39.39	35.10	40.37	45.63	\$45.80	\$52.67	\$59.54
3	35.10	40.37	45.63	39.80	45.77	51.74	52.40	60.26	68.12
4	41.70	47.96	54.21	47.50	54.63	61.75	62.40	71.76	81.12
5	50.50	58.08	65.65	60.00	69.00	78.00	79.60	91.54	103.48
6	59.40	68.31	77.22	70.10	80.62	91.13	96.80	111.32	125.84
7	69.00	79.35	89.70	85.00	97.75	110.50	114.80	132.02	149.24
8	83.20	95.68	108.16	99.30	114.20	129.09	137.40	158.01	178.62
9	98.60	113.39	128.18	115.30	132.60	149.89	162.90	187.34	211.77
10	115.20	132.48	149.76	130.70	150.31	169.91	189.50	217.93	246.35
11	129.40	148.81	168.22	150.40	172.96	195.52	214.50	246.68	278.85
12	146.10	168.02	189.93	171.10	196.77	222.43	242.30	278.65	314.99
13	163.20	187.68	212.16	194.30	223.45	252.59	272.60	313.49	354.38
14	178.80	205.62	232.44	218.10	250.82	283.53	306.50	352.48	398.45
15	199.00	228.85	258.70	245.40	282.21	319.02	343.90	395.49	447.07
16	219.60	252.54	285.48	272.20	313.03	353.86	383.10	440.57	498.03
17	245.80	282.67	319.54	301.30	346.50	391.69	425.30	489.10	552.89
18	272.50	313.38	354.25	332.10	381.92	431.73	468.60	538.89	609.18
19	304.70	350.41	396.11	363.00	417.45	471.90	515.60	592.94	670.28
20	337.30	387.90	438.49	404.90	465.64	526.37	574.40	660.56	746.72
21	372.80	428.72	484.64	442.30	508.65	574.99	624.80	718.52	812.24
22	407.30	468.40	529.49	482.60	554.99	627.38	676.50	777.98	879.45
23	442.80	509.22	575.64	524.70	603.41	682.11	730.40	839.96	949.52
24	479.10	550.97	622.83	567.40	652.51	737.62	782.10	899.42	1,016.73
25	518.20	595.93	673.66	605.50	696.33	787.15	827.20	951.28	1,075.36
26	559.80	643.77	727.74	647.00	744.05	841.10	877.00	1,008.55	1,140.10
27	599.60	689.54	779.48	689.20	792.58	895.96	928.60	1,067.89	1,207.18
28	642.30	738.65	834.99	732.50	842.38	952.25	977.20	1,123.78	1,270.36
29	685.10	787.87	890.63	775.90	892.29	1,008.67	1,028.20	1,182.43	1,336.66
30*	730.70	840.31	949.91	823.30	946.80	1,070.29	1,087.60	1,250.74	1,413.88
31*	773.00	888.95	1,004.90	894.70	1,028.91	1,163.11	1,199.30	1,379.20	1,559.09
32*	822.40	945.76	1,069.12	971.40	1,117.11	1,262.82	1,319.90	1,517.89	1,715.87
33*	870.10	1,000.62	1,131.13	1,048.60	1,205.89	1,363.18	1,441.10	1,657.27	1,873.43
34*	919.40	1,057.31	1,195.22	1,124.10	1,292.72	1,461.33	1,561.60	1,795.84	2,030.08
35*	966.90	1,111.94	1,256.97	1,202.60	1,382.99	1,563.38	1,681.60	1,933.84	2,186.08
36*	1,014.60	1,166.79	1,318.98	1,277.40	1,469.01	1,660.62	1,802.80	2,073.22	2,343.64
37" +	EMAIL FOR QUOTE								

LETTER HEIGHT - MAX DIMENSION

### Additional Pricing Notes:

- Price includes either plain or stud mount and installation pattern / stencil
- Lower case is 75% of the corresponding Upper Case price
- Small punctuation, such as a comma, period and dash are 33% of the Upper Case price

† 1" Letters UPPER CASE ONLY.

## Brass & Bronze



# 1/2" & 3/4" Thick Brass & Bronze Letters

PRICE PER LETTER Including standard mounting with pattern.

LETTER HEIGHT - MAX DIMENSION	1/2" THICK			BRASS ONLY 3/4" THICK		
	Brushed	Oxidized	Polished & Patina	Brushed	Oxidized	Polished
						& Patina
2	\$48.80	\$56.12	\$63.44	\$71.30	\$82.00	\$92.69
3	53.50	61.53	69.55	80.90	93.04	105.17
4	82.00	94.30	106.60	129.60	149.04	168.48
5	99.90	114.89	129.87	152.20	175.03	197.86
6	118.90	136.74	154.57	177.10	203.67	230.23
7	138.40	159.16	179.92	211.60	243.34	275.08
8	168.10	193.32	218.53	248.40	285.66	322.92
9	202.60	232.99	263.38	290.10	333.62	377.13
10	241.80	278.07	314.34	343.50	395.03	446.55
11	285.90	328.79	371.67	407.70	468.86	530.01
12	334.00	384.10	434.20	479.00	550.85	622.70
13	384.50	442.18	499.85	555.10	638.37	721.63
14	437.90	503.59	569.27	632.30	727.15	821.99
15	496.00	570.40	644.80	708.40	814.66	920.92
16	559.70	643.66	727.61	789.30	907.70	1,026.09
17	628.80	723.12	817.44	868.90	999.24	1,129.57
18	700.20	805.23	910.26	952.10	1,094.92	1,237.73
19	772.80	888.72	1,004.64	1,036.40	1,191.86	1,347.32
20	885.90	1,018.79	1,151.67	1,180.20	1,357.23	1,534.26
21	972.60	1,118.49	1,264.38	1,300.30	1,495.35	1,690.39
22	1,058.90	1,217.74	1,376.57	1,437.00	1,652.55	1,868.10
23	1,148.60	1,320.89	1,493.18	1,597.50	1,837.13	2,076.75
24	1,241.30	1,427.50	1,613.69	1,755.60	2,018.94	2,282.28
25	1,329.80	1,529.27	1,728.74	1,912.40	2,199.26	2,486.12
26	1,427.70	1,641.86	1,856.01	2,089.50	2,402.93	2,716.35
27	1,524.60	1,753.29	1,981.98	2,265.40	2,605.21	2,945.02
28	1,623.10	1,866.57	2,110.03	2,441.30	2,807.50	3,173.69
29	1,722.30	1,980.65	2,238.99	2,618.30	3,011.05	3,403.79
30	1,837.50	2,113.13	2,388.75	2,979.70	3,426.66	3,873.61
31	1,949.40	2,241.81	2,534.22	3,185.30	3,663.10	4,140.89
32	2,072.60	2,383.49	2,694.38	3,411.10	3,922.77	4,434.43
33	2,199.30	2,529.20	2,859.09	3,634.60	4,179.79	4,724.98
34	2,324.30	2,672.95	3,021.59	3,862.70	4,442.11	5,021.51
35	2,451.00	2,818.65	3,186.30	4,091.00	4,704.65	5,318.30
36	2,574.20	2,960.33	3,346.46	4,315.60	4,962.94	5,610.28
37" +	EMAIL FOR QUOTE					

**Additional Pricing Notes:**

- Price includes either plain or stud mount and installation pattern / stencil
- Lower case is 75% of the corresponding Upper Case price
- Small punctuation, such as a comma, period and dash are 33% of the Upper Case price

## Brass & Bronze

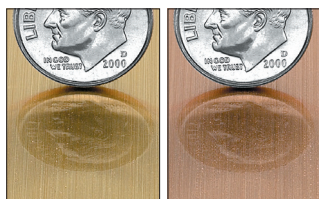

Brushed Brass      Brushed Bronze



Light Oxidized      Oxidized      Dark Oxidized



Polished Brass      Polished Bronze



Verde Patina      Turquoise Patina

# 1/8", 1/4" & 3/8" Thick Copper Letters

PRICE PER LETTER Including standard mounting with pattern.

	1/8" THICK			1/4" THICK			3/8" THICK		
	Brushed	Oxidized	Polished	Brushed	Oxidized	Polished	Brushed	Oxidized	Polished
1" †	\$35.20	\$40.48	---	---	---	---	---	---	---
2	37.60	43.24	---	\$43.60	\$50.14	\$56.68	\$53.30	\$61.30	\$69.29
3	43.60	50.14	\$56.68	54.60	62.79	70.98	66.70	76.71	86.71
4	50.90	58.54	66.17	61.80	71.07	80.34	81.20	93.38	105.56
5	65.40	75.21	85.02	75.10	86.37	97.63	103.00	118.45	133.90
6	78.80	90.62	102.44	94.50	108.68	122.85	123.60	142.14	160.68
7	96.90	111.44	125.97	112.70	129.61	146.51	149.10	171.47	193.83
8	109.00	125.35	141.70	132.10	151.92	171.73	180.60	207.69	234.78
9	137.00	157.55	178.10	153.90	176.99	200.07	214.50	246.68	278.85
10	155.10	178.37	201.63	176.90	203.44	229.97	258.10	296.82	335.53
11	178.20	204.93	231.66	202.40	232.76	263.12	290.80	334.42	378.04
12	198.70	228.51	258.31	230.20	264.73	299.26	330.80	380.42	430.04
13	221.80	255.07	288.34	260.60	299.69	338.78	370.80	426.42	482.04
14	243.60	280.14	316.68	294.50	338.68	382.85	420.50	483.58	546.65
15	270.20	310.73	351.26	330.80	380.42	430.04	465.30	535.10	604.89
16	299.30	344.20	389.09	367.20	422.28	477.36	521.00	599.15	677.30
17	339.20	390.08	440.96	407.10	468.17	529.23	580.40	667.46	754.52
18	374.40	430.56	486.72	448.30	515.55	582.79	641.00	737.15	833.30
19	414.40	476.56	538.72	491.90	565.69	639.47	702.70	808.11	913.51
20	461.70	530.96	600.21	536.80	617.32	697.84	769.40	884.81	1,000.22
21	513.70	590.76	667.81	587.70	675.86	764.01	836.00	961.40	1,086.80
22	562.20	646.53	730.86	641.00	737.15	833.30	905.10	1,040.87	1,176.63
23	610.60	702.19	793.78	694.30	798.45	902.59	974.10	1,120.22	1,266.33
24	659.10	757.97	856.83	752.50	865.38	978.25	1,045.70	1,202.56	1,359.41
25	717.30	824.90	932.49	808.20	929.43	1,050.66	1,113.50	1,280.53	1,447.55
26	775.40	891.71	1,008.02	867.50	997.63	1,127.75	1,180.10	1,357.12	1,534.13
27	833.60	958.64	1,083.68	924.50	1,063.18	1,201.85	1,251.60	1,439.34	1,627.08
28	890.60	1,024.19	1,157.78	980.20	1,127.23	1,274.26	1,320.70	1,518.81	1,716.91
29	947.50	1,089.63	1,231.75	1,037.10	1,192.67	1,348.23	1,386.10	1,594.02	1,801.93
30*	1,005.60	1,156.44	1,307.28	1,094.10	1,258.22	1,422.33	1,453.90	1,671.99	1,890.07
31*	1,061.40	1,220.61	1,379.82	1,176.50	1,352.98	1,529.45	1,584.80	1,822.52	2,060.24
32*	1,125.60	1,294.44	1,463.28	1,268.60	1,458.89	1,649.18	1,724.20	1,982.83	2,241.46
33*	1,194.60	1,373.79	1,552.98	1,361.80	1,566.07	1,770.34	1,865.90	2,145.79	2,425.67
34*	1,257.60	1,446.24	1,634.88	1,451.50	1,669.23	1,886.95	2,005.30	2,306.10	2,606.89
35*	1,324.30	1,522.95	1,721.59	1,543.60	1,775.14	2,006.68	2,147.00	2,469.05	2,791.10
36*	1,384.90	1,592.64	1,800.37	1,636.90	1,882.44	2,127.97	2,286.40	2,629.36	2,972.32
37"+	EMAIL FOR QUOTE								

LETTER HEIGHT - MAX DIMENSION

### Additional Pricing Notes:

- Price includes either plain or stud mount and installation pattern / stencil
- Lower case is 75% of the corresponding Upper Case price
- Small punctuation, such as a comma, period and dash are 33% of the Upper Case price

† 1" Letters UPPER CASE ONLY.

## Copper



Brushed



Light Oxidized



Oxidized



Dark Oxidized



Polished



**LOOKING FOR PREMIUM FINISHES  
AND CHAMFRED EDGES?**

**FLAT CUT METAL**

**Mini Premium Aluminum Letters (3" & Under)-Plain Mount**

Lower Case (LC) is 75% of corresponding Upper Case (UC) price.  
Small punctuation, such as comma, period and dash are 33% of Upper Case (UC) price.

1/8" THICK			
Size	Brushed or Painted	Random / Orbital / Polished	Anodized
1/2"	\$18.20	\$24.57	
3/4	19.36	26.13	
1	20.52	27.70	
1 1/4	21.10	28.48	
1 1/2	21.56	29.11	
1 3/4	22.02	29.73	
2	23.30	31.45	
3	24.23	32.71	

3/16" THICK			
Brushed or Painted	Random / Orbital / Polished	Anodized	Polished Anodized
\$23.42	\$31.61		
24.11	32.55		
24.92	33.65	39.88	48.60
25.62	34.58	40.99	49.95
26.66	35.99	42.66	51.99
27.70	37.40	44.33	54.02
29.33	39.59	46.92	57.19
31.65	42.72	50.63	61.71

1/4" THICK			
Brushed or Painted	Random / Orbital / Polished	Anodized	Polished Anodized
\$24.92	\$33.65		
25.62	34.58		
27.47	37.09	43.96	53.57
28.86	38.97	46.18	56.28
30.25	40.84	48.41	59.00
31.30	42.25	50.08	61.03
32.34	43.66	51.75	63.07
35.70	48.20	57.12	69.62

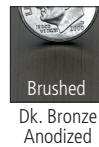
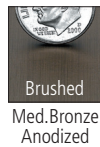
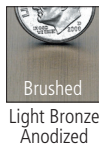
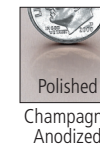
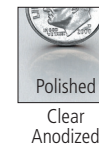
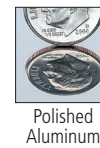
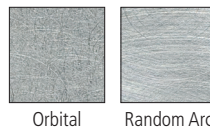
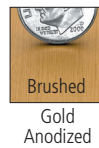
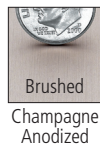
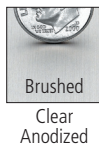

*Plain mount letters can be best installed by either rolling glue on back of letters or carefully applying adhesive using a needle applicator*

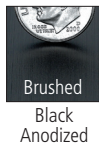
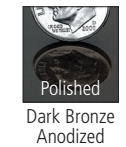
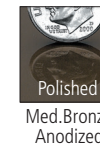
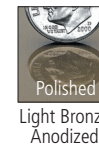

**LOOKING FOR PREMIUM FINISHES  
AND CHAMFRED EDGES?**

**Mini Premium Bronze & Brass Letters (3" & Under)-Plain Mount**

Lower Case (LC) is 75% of corresponding Upper Case (UC) price.  
Small punctuation, such as comma, period and dash are 33% of Upper Case (UC) price.

1/8" THICK			
Size	Brushed	Oxidized	Polished
1/2"	\$24.69	\$28.40	\$33.34
3/4	26.77	30.79	36.14
1	29.08	33.44	39.26
1 1/4	30.23	34.77	40.81
1 1/2	31.16	35.83	42.06
1 3/4	32.42	37.29	43.77
2	35.08	40.34	47.36
3	36.81	42.33	49.69

3/16" THICK			
Size	Brushed	Oxidized	Polished
1/2"	\$34.96	\$40.21	\$47.20
3/4	36.46	41.93	49.23
1	37.85	43.53	51.10
1 1/4	40.16	46.18	54.21
1 1/2	44.54	51.22	60.13
1 3/4	48.93	56.26	66.05
2	54.35	62.50	73.37
3	57.12	65.69	77.11

1/4" THICK			
Size	Brushed	Oxidized	Polished
1/2"	\$35.43	\$40.74	\$47.82
3/4	36.93	42.46	49.85
1	39.46	45.38	53.28
1 1/4	42.23	48.57	57.01
1 1/2	46.16	53.08	62.31
1 3/4	51.70	59.45	69.79
2	55.85	64.23	75.40
3	59.89	68.87	80.85

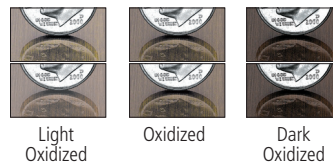
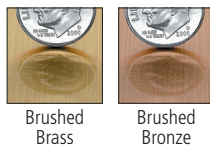





## **FORGING A LASTING IMPRESSION**

Gemini's hand-cast metal letters and logos signal unmistakable elegance and bring a timeless sense of tradition to indoor and outdoor signage. From university campuses to professional services and government offices, cast metal defines permanence, authority and sophistication.

# G CAST METAL

Flat, round, prismatic or your own custom face profile

Wide variety of different standard finishes

Multi-set discounts on custom

Larger letters & logos up to 64" available custom

Industry-leading lead times

## CLASS & DISTINCTION

For decades, Gemini has been a leading producer of the highest quality, hand-finished cast aluminum and bronze letters in our metal foundries, with all-electric, pollution-free furnaces.

Obtain this timeless look with surprising economy in your choice of cast bronze or aluminum. Choose a variety of finish options, including polished, oxidized and anodized, performed in-house, produced and shipped with industry leading lead times.



### WHEN ORDERING

PLEASE SPECIFY:

- Install Environment
- Size (Height)
- Finish Selection
- Vector Art or Standard Font
- Thickness
- Install Method



## Aluminum: Painted Colors

 5687 White Approx PMS White	 2718 Ivory Approx PMS 7499	 4660 Desert Sand Approx PMS 7506	 0209 Grey Approx PMS 423	 4310 Dove Grey Approx PMS 431	 8090 Safety Green Approx PMS 809	 2037 Lemon Yellow Approx PMS 102	 2000 Yellow Approx PMS 108
 0217 Citrus Yellow Approx PMS 606	 0218 Sundance Yellow Approx PMS 116	 0254 Mango Approx PMS 137	 2119 Orange Approx PMS 21	 2662 Red-Orange Approx PMS 485	 0256 Rampart Orange Approx PMS 172	 2793 Red Approx PMS 185	 1875 Brick Red Approx PMS 7623
 2280 Black Cherry Approx PMS 1817	 2240 Maroon Approx PMS 202	 2410 Magenta Approx PMS 241	 2287 Purple Approx PMS 2695	 0246 Violet Toner Approx PMS 2725	 2767 Midnight Blue Approx PMS 5395	 2050 Dark Blue Approx PMS 281	 2860 Medium Blue Approx PMS 286
 3000 Blue Approx PMS 300	 2648 Light Blue Approx PMS 2995	 5425 Marine Reef Blue Approx PMS 5425	 3210 Teal Blue Approx PMS 321	 3555 Spring Green Approx PMS 355	 0222 Emerald Green Approx PMS 356	 0259 Federal Green Approx PMS 350	 2108 Light Green Approx PMS 3415
 2030 Dark Green Approx PMS 3435	 2162 Hunter Green Approx PMS 3308	 0400 Brilliant Gold Approx PMS 7556	 2756 Metallic Gold* Approx PMS 465	 0401 Aztec Gold Approx PMS 2317	 0253 Copper Approx PMS 7600	 0402 Aztec Copper Approx PMS 7599	 2418 Brown Approx PMS 476
 0312 Medium Bronze* Approx PMS 2335	 0314 Old Copper* Approx PMS 2334	 3130 Duranodic Bronze* Approx PMS 2336	 1315 Dark Oxide Approx PMS 447	 8886 Metallic Silver* Approx PMS 3435	 2025 Black Approx PMS Black		

### Custom Paint Color:

It's easy to request custom color matching! Simply tell us the paint number or name and brand of paint you'd like us to match (e.g. PMS 186 or Sherwin-Williams Boathouse Blue) and we will obtain a mixing formula at no cost to you.

Don't have a paint name or number and still need a color exactly matched? Please send us a sample (sample item must be at least 3" x 3") and our paint lab will run it through an exacting color match process. Exact color matching from a sample is \$200.

## Aluminum Alloy 514: Brushed Finishes

#4 brushed, Random Arc & Orbital are available in all anodized finishes as well as aluminum and bronze.



Brushed

#4 Brushed

Random Arc

Orbital

Rust Powdercoat

## Aluminum: Anodized Finishes

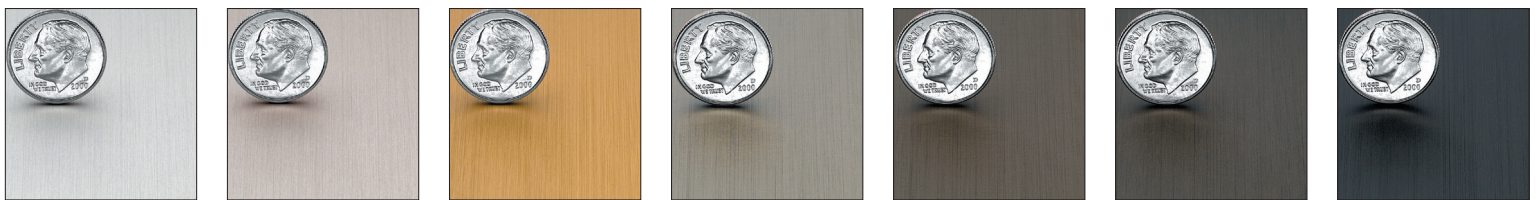

Clear

Champagne

Gold

Light Bronze

Medium Bronze

Dark Bronze

Black

### Anodized Aluminum:

Anodized finishes are not just coatings... they are a part of the finished aluminum letter. Anodizing is an electrochemical process that hardens aluminum and allows it to be colorized. We perform our own anodizing to ensure your letters within the same order have color consistency and are delivered to you within days. Some of the many reasons to have Gemini anodize your aluminum letters include: Abrasion and weather resistant; Beautiful finish; Increases hardness and durability; Will not crack or peel; Unaffected by sunlight / UV; Environmentally friendly; Cost effective. Note: Colors may vary slightly from order to order.

## Bronze: NAVY-G 88-8-0-4



Brushed

Polished

#4 Brushed

Light Oxidized

Oxidized

Dark Oxidized



Verde Patina

Turquoise Patina

### BRONZE FINISH NOTES:

**OXIDIZED:** Color matching of existing oxidized letters is available with a customer supplied sample.

**PATINA:** All Patinas, by their very nature, will vary from letter to letter and order to order. These finishes will change in appearance over time depending on contact with moisture and temperature. Patinas can "bleed" onto the installation surface when installed outside.

**POLISHING:** Requires a minimum of .5" stroke. Restrictions may apply on letters/logos over 24".

# Mounting Options

Go to GeminiSignage.com to view, print or save .pdf CAD drawings of all mounting and construction options.

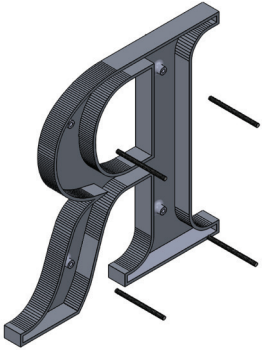

### Stud Mount - Standard

Backs of letters and logos are drilled and tapped to received threaded studs for mounting. Standard cast studs are in-line for brick mortar (2-5/8" on center)

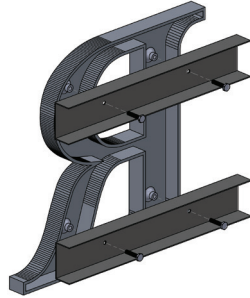

### 3A - Double Rail Mount

Includes painted or anodized aluminum c-channel rails. Email for quote.

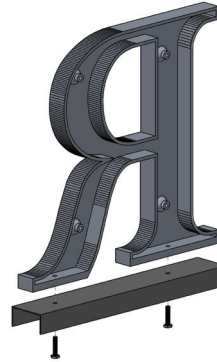

### 3B - Bottom & Top Rail Mount

Letters 4"-30", Minimum 3/8" thick  
Includes painted or anodized aluminum c-channel rails. Letters over 8" may require tie-back (not supplied). Email for quote.

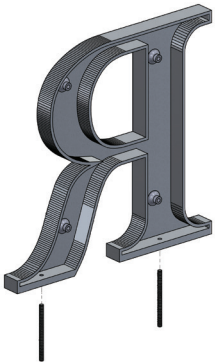

### 3C - Bottom or Top Stud

Letters 4"-30", Minimum 3/8" thick  
Letters over 8" may require tie-back (not supplied). Email for quote.

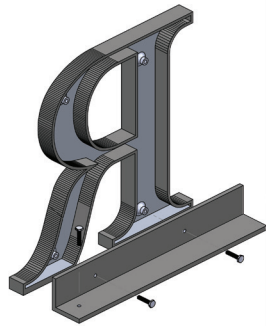

### 3D - Bottom Back Angle Bracket Mount

Letters 4"-30", Minimum 3/8" thick.  
Letters over 8" may require tie-back (not supplied). Aluminum angle is 2" x 2" with a painted finish. Email for quote.

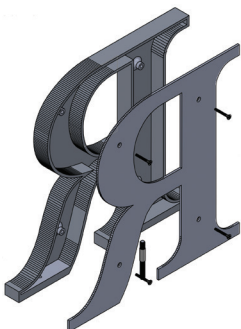

### Bottom Stud w/Back Email for quote

Letters 4"-24", Minimum 3/8" thick  
Includes painted or anodized 1/8" thick aluminum back. Letters over 8" may require tie-back (not supplied). Can be full cover or inset for flush edge.

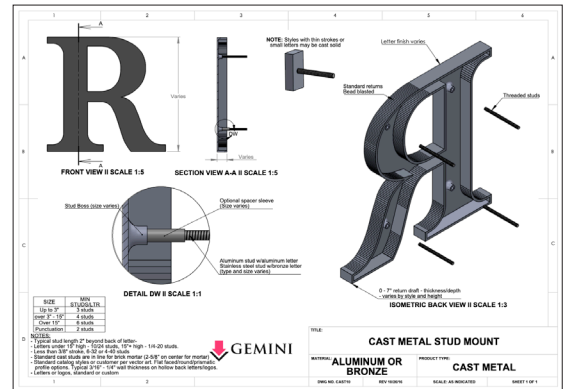

### CAD Drawings:

A complete list of downloadable PDFs can be found by clicking on the CAD drawing above.

## Stud Specifications

- Cast letters under 15" are shipped with 10/24 threaded studs-standard. (Thin strokes, 4/40 or 6/32 studs).
- Cast letters 15" + are shipped with 1/4-20 studs-standard.
- Cast Aluminum letters - Aluminum studs standard (Stainless steel available upon request).
- Cast Bronze letters - Stainless steel studs are standard.
- Metal spacers available upon request (specify stand-off distance).
- Stud for Brick, 2-5/8" on center, no extra fee
- Stud for Block, 8" on center, no extra fee
- Studs in-line for horizontal alignment no extra fee. (rail not included)
- Custom stud placement available up to 14" - Email for Quote



# Most Popular Cast Aluminum Flat Face Fonts

PRICE PER LETTER: Including standard mounting and pattern



ARIAL **ABC**

Helvetica **ABC**

		ALUMINUM		
UPPER CASE ONLY		BRUSHED or PAINTED	ANODIZED	#4 BRUSHED, RANDOM ARC, ORBITAL or RUST POWDERCOAT
UPPER	DEPTH			
4"	5/8"	\$31.00	\$38.75	\$40.30
6	3/4	42.00	52.50	54.60
8	3/4	53.00	66.25	68.90
10	1	73.00	91.25	94.90
12	1	88.00	110.00	114.40
15	1 1/4	136.00	170.00	176.80
18	1 1/2	170.00	212.50	221.00
24	1 1/2	262.00	327.50	340.60

			ALUMINUM		
UPPER	LOWER	DEPTH	BRUSHED or PAINTED	ANODIZED	#4 BRUSHED, RANDOM ARC, ORBITAL or RUST POWDERCOAT
3	2 1/4	1/2	25.00	31.25	32.50
4	3	5/8	29.00	36.25	37.70
5	3 3/4	3/4	38.00	47.50	49.40
6	4 1/2	3/4	41.00	51.25	53.30
8	6	3/4	51.00	63.75	66.30
9	6 3/4	3/4	64.00	80.00	83.20
10	7 1/2	1	65.00	81.25	84.50
12	9	1	77.00	96.25	100.10
14	10 1/2	1	110.00	137.50	143.00
15	11 1/4	1 1/4	126.00	157.50	163.80
16	12	1 1/4	136.00	170.00	176.80
18	13 1/2	1 1/2	165.00	206.25	214.50
20	15	1 1/2	215.00	268.75	279.50
24	18	1 1/2	269.00	336.25	349.70

Times New Roman **ABC**

		ALUMINUM			
UPPER	LOWER	DEPTH	BRUSHED or PAINTED	ANODIZED	#4 BRUSHED, RANDOM ARC, ORBITAL or RUST POWDERCOAT
3	NA	1/2	25.00	31.25	32.50
4	2 5/8"	5/8	29.00	36.25	37.70
5	3 1/2	3/4	38.00	47.50	49.40
6	4	3/4	40.00	50.00	52.00
8	5 1/2	3/4	51.00	63.75	66.30
9	6 1/4	3/4	64.00	80.00	83.20
10	6 3/4	1	65.00	81.25	84.50
12	8 1/8	1	82.00	102.50	106.60
15	10	1 1/4	135.00	168.75	175.50
16	11	1 1/4	136.00	170.00	176.80
18	12 1/2	1 1/2	167.00	208.75	217.10
20	13 3/4	1 1/2	214.00	267.50	278.20
24	16 1/2	1 1/2	266.00	332.50	345.80

- Additional Pricing Notes:**
- Price includes stud mounts and installation pattern
  - Lower case, where available, is 90% of the corresponding Upper Case price
  - Small punctuation, such as a comma, period and dash are 33% of the Upper Case price
  - Custom sizes available.  
Email: Signage@GeminiMade.com

# Most Popular Cast Aluminum Prismatic Face Fonts

PRICE PER LETTER: Including standard mounting and pattern

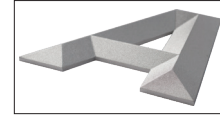

Architectural **ABC**

TRAJAN  
BOLD

**ABC**

ALUMINUM					
UPPER	LOWER	DEPTH	BLASTED or PAINTED		
			ANODIZED	RUST POWDERCOAT	
2"	NA	3/8"	\$32.00	\$40.00	\$41.60
3	NA	1/2	41.00	51.25	53.30
4	NA	5/8	48.00	60.00	62.40
5	NA	5/8	59.00	73.75	76.70
6	4"	5/8	62.00	77.50	80.60
8	5 1/2	3/4	75.00	93.75	97.50
10	6 7/8	3/4	98.00	122.50	127.40
12	8 1/4	1	118.00	147.50	153.40
14	9 5/8	1	156.00	195.00	202.80
16	11	1 1/4	196.00	245.00	254.80
18	12 3/8	1 1/4	244.00	305.00	317.20
24	16 1/2	1 1/2	429.00	536.25	557.70

ALUMINUM					
UPPER CASE ONLY		BLASTED or PAINTED			
UPPER	DEPTH	ANODIZED	RUST POWDERCOAT		
4"	5/8"	\$53.00	\$66.25	\$68.90	
6	3/4	77.00	96.25	100.10	
8	3/4	81.00	101.25	105.30	
10	1	107.00	133.75	139.10	
12	1	121.00	151.25	157.30	
15	1 1/4	201.00	251.25	261.30	
18	1 1/2	251.00	313.75	326.30	

Prismatic  
Star



ALUMINUM				
UPPER	DEPTH	BLASTED or PAINTED		
		ANODIZED	RUST POWDERCOAT	
2"	3/8"	\$57.00	\$71.25	\$74.10
3"	1/2	59.00	73.75	76.70
4	5/8	60.00	75.00	78.00
5	3/4	66.00	82.50	85.80
6	3/4	75.00	93.75	97.50
7	3/4	95.00	118.75	123.50
8	3/4	108.00	135.00	140.40
10	1	123.00	153.75	159.90
12	1	130.00	162.50	169.00
18	1 1/2	213.00	266.25	276.90
24	1 1/2	334.00	417.50	434.20

### Additional Pricing Notes:

- Price includes stud mounts and installation pattern
- Lower case, where available, is 90% of the corresponding Upper Case price
- Small punctuation, such as a comma, period and dash are 33% of the Upper Case price
- Custom sizes available.  
Email: [Signage@GeminiMade.com](mailto:Signage@GeminiMade.com)

# Flat Face Cast Aluminum Standard Letter Pricing

PRICE PER LETTER: Including standard mounting and pattern

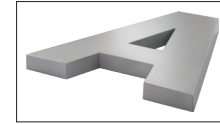

UPPER	ALUMINUM		
	BRUSHED or PAINTED	ANODIZED	#4 BRUSHED, RANDOM ARC, ORBITAL or RUST POWDERCOAT
4"	\$34.00	\$42.50	\$44.20
6	47.00	58.75	61.10
8	61.00	76.25	79.30
10	76.00	95.00	98.80
12	91.00	113.75	118.30
15	135.00	168.75	175.50
18	189.00	236.25	245.70
24	285.00	356.25	370.50

- Additional Pricing Notes:**
- Price includes stud mounts and installation pattern
  - Lower case, where available, is 90% of the corresponding Upper Case price
  - Small punctuation, such as a comma, period and dash are 33% of the Upper Case price
  - Additional fonts and sizes available. Email [Signage@GeminiMade.com](mailto:Signage@GeminiMade.com)

**VIEW  
DEPTHS & STROKES**

## Standard Cast Styles \* Only available in Upper Case

Adrianna Demibold	<b>EUROSTYLE BOLD EXT.*</b>	<b>Helvetica Bold</b>	PALATINO*
<b>Adrianna Bold</b>	<b>Fairbanks</b>	HELVETICA BOLD EXT.	PALATINO SEMIBOLD*
<b>Adrianna Extrabold</b>	Forward Thinking	<b>Helvetica Medium Cond.</b>	RIBBON*
AMERICANA BOLD*	FRIZ QUADRATA*	<i>Helvetica Med. Italic</i>	RIBBON CONDENSED*
<b>Arial Bold</b>	<b>FUTURA*</b>	HELVETICA LIGHT*	RIBBON DEEP*
AVANT GARDE*	<b>FUTURA BOLD*</b>	Hydropower Extracondensed	ROFFE*
CLARENDON FORTUNE BOLD*	GARAMOND BOLD*	KABEL*	<b>Roman</b>
CLARENDON MED.*	GARAMOND REG.*	<b>Kegger</b>	STANDARD BLOCK
COPPERPLATE*	<b>GIL SANS BOLD*</b>	Optima	<b>Times Bold</b>
CRAW CLARENDON COND*	Goudy Extra Bold	<b>OPTIMA SEMIBOLD*</b>	TWENTIETH CENTURY*
			<b>UNIVERS 67*</b>



# Flat Face Cast Aluminum Custom Letter Pricing

PRICE PER LETTER: Including standard mounting and pattern

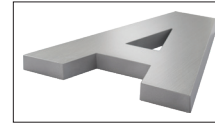

LETTER HEIGHT - MAX DIMENSION	SIZE	DEPTH	1 - 5 SETS			6+ SETS		
			BRUSHED or PAINTED	ANODIZED	#4 BRUSHED, RANDOM ARC, ORBITAL or RUST POWDERCOAT	BRUSHED or PAINTED	ANODIZED	#4 BRUSHED, RANDOM ARC, ORBITAL or RUST POWDERCOAT
	4"	1/2"	\$54.70	\$68.38	\$71.11	\$47.00	\$58.75	\$61.10
	5	3/4	59.70	74.63	77.61	50.80	63.50	66.04
	6	3/4	61.10	76.38	79.43	52.20	65.25	67.86
	7	3/4	71.20	89.00	92.56	61.10	76.38	79.43
	8	3/4	80.10	100.13	104.13	68.70	85.88	89.31
	9	3/4	90.30	112.88	117.39	76.20	95.25	99.06
	10	1	101.60	127.00	132.08	86.50	108.13	112.45
	11	1	110.50	138.13	143.65	94.10	117.63	122.33
	12	1	119.50	149.38	155.35	101.60	127.00	132.08
	13	1	141.10	176.38	183.43	119.50	149.38	155.35
	14	1	162.70	203.38	211.51	138.50	173.13	180.05
	15	1-1/4	202.00	252.50	262.60	171.50	214.38	222.95
	16	1-1/4	207.20	259.00	269.36	176.60	220.75	229.58
	17	1-1/4	231.20	289.00	300.56	196.90	246.13	255.97
	18	1-1/2	245.30	306.63	318.89	208.40	260.50	270.92
	19	1-1/2	264.30	330.38	343.59	224.90	281.13	292.37
	20	1-1/2	279.50	349.38	363.35	237.60	297.00	308.88
	21	1-1/2	294.80	368.50	383.24	250.30	312.88	325.39
	22	1-1/2	315.20	394.00	409.76	268.10	335.13	348.53
	23	1-1/2	331.60	414.50	431.08	282.10	352.63	366.73
	24	1-1/2	349.40	436.75	454.22	297.30	371.63	386.49
	25	1-1/2	565.30	706.63	734.89	480.30	600.38	624.39
	26	1-1/2	613.70	767.13	797.81	522.20	652.75	678.86
	27	1-1/2	659.40	824.25	857.22	560.30	700.38	728.39
	28	1-1/2	709.00	886.25	921.70	602.20	752.75	782.86
	29	1-1/2	761.00	951.25	989.30	646.70	808.38	840.71
	30*	1-1/2	813.10	1,016.38	1,057.03	691.10	863.88	898.43
	31+		EMAIL FOR QUOTE					

\*Oversize charges will apply

**Note:**

Custom depths can be specified in 1/4" increments from 1/2" to 1-1/4", and in 1/2" increments from 1-1/2" to 3". Depths above 1-1/2" email for quote.

**Additional Pricing Notes:**

- Price includes stud mounts and installation pattern
- Lower case, where available, is 90% of the corresponding Upper Case price
- Small punctuation, such as a comma, period and dash are 33% of the Upper Case price

# Round or Prismatic Cast Aluminum Custom Letter Pricing

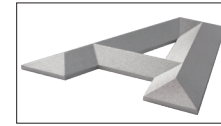
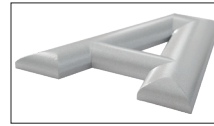

**PRICE PER LETTER: Including standard mounting and pattern**

SIZE	DEPTH	1 SET			2 - 5 SETS			6+ SETS		
		BLASTED or PAINTED	ANODIZED	RUST POWDERCOAT	BLASTED or PAINTED	ANODIZED	RUST POWDERCOAT	BLASTED or PAINTED	ANODIZED	RUST POWDERCOAT
4"	1/2"	\$129.70	\$162.13	\$168.61	\$97.90	\$122.38	\$127.27	\$77.60	\$97.00	\$100.88
5	3/4	129.70	162.13	168.61	97.90	122.38	127.27	77.60	97.00	100.88
6	3/4	129.70	162.13	168.61	97.90	122.38	127.27	77.60	97.00	100.88
7	3/4	148.70	185.88	193.31	113.20	141.50	147.16	89.00	111.25	115.70
8	3/4	174.20	217.75	226.46	131.00	163.75	170.30	104.30	130.38	135.59
9	3/4	197.00	246.25	256.10	147.50	184.38	191.75	119.50	149.38	155.35
10	1	222.40	278.00	289.12	167.80	209.75	218.14	133.50	166.88	173.55
11	1	240.30	300.38	312.39	180.50	225.63	234.65	143.70	179.63	186.81
12	1	264.50	330.63	343.85	198.40	248.00	257.92	160.20	200.25	208.26
13	1	312.80	391.00	406.64	235.20	294.00	305.76	188.20	235.25	244.66
14	1	355.90	444.88	462.67	268.30	335.38	348.79	214.90	268.63	279.37
15	1-1/4	446.20	557.75	580.06	334.40	418.00	434.72	269.50	336.88	350.35
16	1-1/4	461.50	576.88	599.95	345.80	432.25	449.54	278.40	348.00	361.92
17	1-1/4	511.00	638.75	664.30	383.90	479.88	499.07	433.50	541.88	563.55
18	1-1/2	547.90	684.88	712.27	410.70	513.38	533.91	330.50	413.13	429.65
19	1-1/2	587.30	734.13	763.49	441.10	551.38	573.43	352.10	440.13	457.73
20	1-1/2	622.90	778.63	809.77	467.90	584.88	608.27	375.00	468.75	487.50
21	1-1/2	661.00	826.25	859.30	495.70	619.63	644.41	396.60	495.75	515.58
22	1-1/2	699.10	873.88	908.83	526.30	657.88	684.19	420.80	526.00	547.04
23	1-1/2	738.60	923.25	960.18	554.30	692.88	720.59	443.70	554.63	576.81
24	1-1/2	780.50	975.63	1,014.65	586.10	732.63	761.93	467.90	584.88	608.27
25	1-1/2	819.90	1,024.88	1,065.87	615.30	769.13	799.89	492.00	615.00	639.60
26	1-1/2	945.80	1,182.25	1,229.54	709.40	886.75	922.22	567.00	708.75	737.10
27	1-1/2	1,067.70	1,334.63	1,388.01	800.80	1,001.00	1,041.04	640.70	800.88	832.91
28	1-1/2	1,192.40	1,490.50	1,550.12	894.90	1,118.63	1,163.37	715.70	894.63	930.41
29	1-1/2	1,317.00	1,646.25	1,712.10	987.70	1,234.63	1,284.01	790.70	988.38	1,027.91
30*	1-1/2	1,440.30	1,800.38	1,872.39	1,080.50	1,350.63	1,404.65	864.40	1,080.50	1,123.72
31+		EMAIL FOR QUOTE								

LETTER HEIGHT - MAX DIMENSION

\*Oversize charges will apply

**Note:**

Custom depths can be specified in 1/4" increments from 1/2" to 1-1/4", and in 1/2" increments from 1-1/2" to 3". Depths above 1-1/2" email for quote.

**Additional Pricing Notes:**

- Price includes stud mounts and installation pattern
- Lower case, where available, is 90% of the corresponding Upper Case price
- Small punctuation, such as a comma, period and dash are 33% of the Upper Case price

# Flat Face Cast Aluminum Logo Pricing

## PRICE PER LOGO. Including standard mounting with pattern.

Logos with 3 or more pieces may have additional charges.

SIZE	Up to		14"	15"	16"	17"	18"	19"	20"	21"	22"	23"	24"	25"	26"	27"	28"	29"	30"*
	12"	13"																	
Up to 12"	\$180	\$189	\$202	\$212	\$220	\$234	\$242	\$253	\$266	\$275	\$289	\$302	\$316	\$329	\$341	\$355	\$368	\$380	\$394
13	189	198	208	220	229	240	258	272	284	300	313	328	341	356	369	385	399	410	427
14	202	208	214	234	244	262	275	292	308	324	338	354	368	382	399	411	428	441	459
15	212	220	234	244	262	279	295	312	329	344	362	374	394	408	427	440	459	631	653
16	220	229	244	262	280	296	316	334	349	368	385	402	421	435	455	626	650	672	697
17	234	240	262	279	296	316	335	355	372	390	407	427	444	463	642	664	692	714	740
18	242	258	275	295	316	335	355	373	394	411	432	452	626	653	677	707	729	757	781
19	253	272	292	312	334	355	373	394	413	437	457	556	661	689	716	746	773	802	824
20	266	284	308	329	349	372	394	413	435	459	638	666	697	724	753	781	812	842	869
21	275	300	324	344	368	390	411	437	459	562	671	702	729	762	791	821	852	884	913
22	289	313	338	362	385	407	432	457	638	671	704	733	766	799	826	860	892	922	957
23	302	328	354	374	402	427	452	556	666	702	733	769	802	836	867	901	931	967	1,000
24	316	341	368	394	421	444	626	661	697	729	766	802	835	869	903	939	972	1,007	1,040
25	329	356	382	408	435	463	653	689	724	762	799	836	869	907	942	979	1,012	1,052	1,086
26	341	369	399	427	455	642	677	716	753	791	826	867	903	942	977	1,016	1,055	1,091	1,128
27	355	385	411	440	626	664	707	746	781	821	860	901	939	979	1,016	1,052	1,094	1,123	1,171
28	368	399	428	459	650	692	729	773	812	852	892	931	972	1,012	1,055	1,094	1,135	1,173	1,216
29	380	410	441	631	672	714	757	802	842	884	922	967	1,007	1,052	1,091	1,123	1,173	1,196	1,257
30*	394	427	459	653	697	740	781	824	869	913	957	1,000	1,040	1,086	1,128	1,171	1,216	1,257	1,300
31*	406	438	630	674	719	763	809	854	898	945	990	1,035	1,075	1,123	1,166	1,196	1,255	1,267	1,345
32*	421	455	650	697	744	787	835	880	926	972	1,019	1,066	1,110	1,159	1,202	1,249	1,295	1,342	1,388
33*	432	468	671	716	766	813	860	909	957	1,005	1,051	1,100	1,144	1,196	1,243	1,267	1,334	1,386	1,430
34*	444	642	692	740	787	840	885	935	984	1,031	1,080	1,133	1,181	1,228	1,278	1,326	1,377	1,424	1,474
35*	459	659	710	760	812	862	913	964	1,012	1,064	1,112	1,166	1,216	1,267	1,317	1,370	1,416	1,460	1,518
36*	626	677	729	781	835	885	939	994	1,040	1,094	1,144	1,196	1,249	1,300	1,353	1,405	1,457	1,509	1,560
37*	639	709	792	819	868	915	978	1,027	1,074	1,118	1,176	1,217	1,266	1,319	1,396	1,420	1,469	1,532	1,570
38*	647	730	804	846	889	931	1,003	1,045	1,089	1,130	1,189	1,231	1,276	1,331	1,417	1,430	1,475	1,546	1,575
40*	675	759	846	874	917	990	1,031	1,089	1,132	1,195	1,231	1,282	1,295	1,376	1,432	1,469	1,518	1,569	1,661
42*	718	781	881	917	980	1,038	1,061	1,115	1,161	1,221	1,276	1,309	1,331	1,420	1,503	1,541	1,569	1,658	1,742
44*	788	846	903	962	1,003	1,067	1,118	1,155	1,195	1,271	1,311	1,353	1,376	1,486	1,540	1,581	1,603	1,723	1,827
46*	860	874	931	990	1,104	1,132	1,183	1,220	1,246	1,308	1,360	1,400	1,432	1,541	1,646	1,701	1,745	1,830	1,906
48*	1,017	1,038	1,089	1,161	1,202	1,289	1,325	1,376	1,432	1,518	1,603	1,661	1,716	1,761	1,810	1,847	1,889	2,060	2,188

49+ EMAIL FOR QUOTE

\*Oversize charges will apply

### Price As Listed



Brushed

Painted

### Add 25% - Anodized



Clear

Champagne

Gold

Black

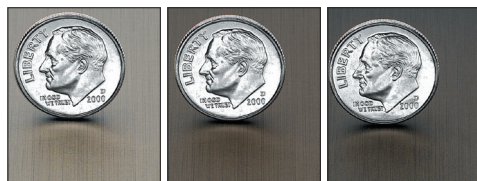

Light Bronze

Medium Bronze

Dark Bronze

### Add 30%



#4 Brushed

Rust Powdercoat

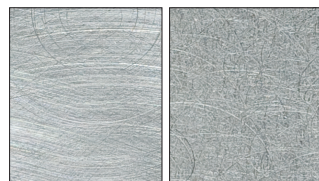

Random Arc

Orbital







# Most Popular Cast Bronze Flat Face Fonts

PRICE PER LETTER: Including standard mounting and pattern

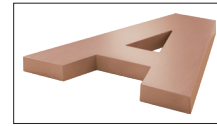

ARIAL **ABC**

Helvetica **ABC**

UPPER CASE ONLY		BRONZE		
UPPER	DEPTH	BRUSHED	OXIDIZED	POLISHED or PATINA
4"	5/8"	\$66.00	\$75.90	\$85.80
6	3/4	89.00	102.35	115.70
8	3/4	120.00	138.00	156.00
10	1	155.00	178.25	201.50
12	1	225.00	258.75	292.50
15	1 1/4	318.00	365.70	413.40
18	1 1/2	451.00	518.65	586.30
24	1 1/2	719.00	826.85	934.70

UPPER CASE ONLY			BRONZE		
UPPER	LOWER	DEPTH	BRUSHED	OXIDIZED	POLISHED or PATINA
2"	1 1/2"	3/8"	\$32.00	\$36.80	\$41.60
3	2 1/4	1/2	49.00	56.35	63.70
4	3	5/8	58.00	66.70	75.40
5	3 3/4	3/4	75.00	86.25	97.50
6	4 1/2	3/4	81.00	93.15	105.30
8	6	3/4	110.00	126.50	143.00
9	6 3/4	3/4	116.00	133.40	150.80
10	7 1/2	1	121.00	139.15	157.30
12	9	1	187.00	215.05	243.10
14	10 1/2	1	225.00	258.75	292.50
15	11 1/4	1 1/4	266.00	305.90	345.80
16	12	1 1/4	277.00	318.55	360.10
18	13 1/2	1 1/2	384.00	441.60	499.20
20	15	1 1/2	496.00	570.40	644.80
24	18	1 1/2	649.00	746.35	843.70

Times New Roman **ABC**

UPPER CASE ONLY		BRONZE			
UPPER	LOWER	DEPTH	BRUSHED	OXIDIZED	POLISHED or PATINA
2"	NA	3/8"	\$36.00	\$41.40	\$46.80
3	NA	1/2	57.00	65.55	74.10
4	2 5/8"	5/8	61.00	70.15	79.30
5	3 1/2	3/4	82.00	94.30	106.60
6	4	3/4	88.00	101.20	114.40
8	5 1/2	3/4	114.00	131.10	148.20
9	6 1/4	3/4	132.00	151.80	171.60
10	6 3/4	1	133.00	152.95	172.90
12	8 1/8	1	199.00	228.85	258.70
15	10	1 1/4	275.00	316.25	357.50
16	11	1 1/4	299.00	343.85	388.70
18	12 1/2	1 1/2	387.00	445.05	503.10
20	13 3/4	1 1/2	534.00	614.10	694.20
24	16 1/2	1 1/2	668.00	768.20	868.40

**Additional Pricing Notes:**

- Price includes stud mounts and installation pattern
- Lower case, where available, is 90% of the corresponding Upper Case price
- Small punctuation, such as a comma, period and dash are 33% of the Upper Case price
- Custom sizes available.  
Email: Signage@GeminiMade.com

# Most Popular Cast Bronze Prismatic Face Fonts

PRICE PER LETTER: Including standard mounting and pattern

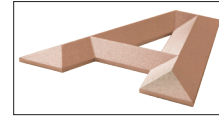

## Architectural ABC

## TRAJAN BOLD



UPPER	LOWER	DEPTH	BRONZE		
			BLASTED	OXIDIZED	POLISHED or PATINA
2"	NA	3/8"	\$70.00	\$80.50	\$91.00
3	NA	1/2	80.00	92.00	104.00
4	NA	5/8	93.00	106.95	120.90
5	NA	5/8	103.00	118.45	133.90
6	4"	5/8	119.00	136.85	154.70
8	5 1/2	3/4	158.00	181.70	205.40
10	6 7/8	3/4	201.00	231.15	261.30
12	8 1/4	1	295.00	339.25	383.50
14	9 5/8	1	390.00	448.50	507.00
16	11	1 1/4	512.00	588.80	665.60
18	12 3/8	1 1/4	613.00	704.95	796.90
24	16 1/2	1 1/2	847.00	974.05	1,101.10

UPPER CASE ONLY		BRONZE		
UPPER	DEPTH	BLASTED	OXIDIZED	POLISHED or PATINA
4"	5/8"	\$93.00	\$106.95	\$120.90
6	3/4	121.00	139.15	157.30
8	3/4	180.00	207.00	234.00
10	1	237.00	272.55	308.10
12	1	295.00	339.25	383.50
15	1 1/4	479.00	550.85	622.70
18	1 1/2	645.00	741.75	838.50

## Prismatic Star



UPPER	DEPTH	BRONZE		
		BLASTED	OXIDIZED	POLISHED or PATINA
2"	3/8"	\$114.00	\$131.10	\$148.20
3"	1/2	115.00	132.25	149.50
4	5/8	116.00	133.40	150.80
5	3/4	137.00	157.55	178.10
6	3/4	154.00	177.10	200.20
7	3/4	193.00	221.95	250.90
8	3/4	231.00	265.65	300.30
10	1	254.00	292.10	330.20
12	1	276.00	317.40	358.80
18	1 1/2	455.00	523.25	591.50
24	1 1/2	719.00	826.85	934.70

### Additional Pricing Notes:

- Price includes stud mounts and installation pattern
- Lower case, where available, is 90% of the corresponding Upper Case price
- Small punctuation, such as a comma, period and dash are 33% of the Upper Case price
- Custom sizes available.  
Email: [Signage@GeminiMade.com](mailto:Signage@GeminiMade.com)



# Flat Face Cast Bronze Standard Letter Pricing

PRICE PER LETTER: Including standard mounting and pattern



UPPER	BRONZE		POLISHED or PATINA
	BRUSHED	OXIDIZED	
4"	\$80.00	\$92.00	\$104.00
6	99.00	113.85	128.70
8	133.00	152.95	172.90
10	177.00	203.55	230.10
12	234.00	269.10	304.20
15	336.00	386.40	436.80
18	510.00	586.50	663.00
24	769.00	884.35	999.70

**Additional Pricing Notes:**

- Price includes stud mounts and installation pattern
- Lower case, where available, is 90% of the corresponding Upper Case price
- Small punctuation, such as a comma, period and dash are 33% of the Upper Case price
- Additional fonts and sizes available. Email Signage@GeminiMade.com

## VIEW DEPTHS & STROKES

## Standard Cast Styles \* Only available in Upper Case

Adrianna Demibold	<b>EUROSTYLE BOLD EXT.*</b>	<b>Helvetica Bold</b>	PALATINO*
<b>Adrianna Bold</b>	<b>Fairbanks</b>	HELVETICA BOLD EXT.	PALATINO SEMIBOLD*
<b>Adrianna Extrabold</b>	Forward Thinking	<b>Helvetica Medium Cond.</b>	RIBBON*
AMERICANA BOLD*	FRIZ QUADRATA*	<i>Helvetica Med. Italic</i>	RIBBON CONDENSED*
<b>Arial Bold</b>	<b>FUTURA*</b>	HELVETICA LIGHT*	RIBBON DEEP*
AVANT GARDE*	<b>FUTURA BOLD*</b>	Hydropower Extracondensed	ROFFE*
CLARENDON FORTUNE BOLD*	<b>GARAMOND BOLD*</b>	KABEL*	<b>Roman</b>
CLARENDON MED.*	GARAMOND REG.*	<b>Kegger</b>	STANDARD BLOCK
COPPERPLATE*	<b>GIL SANS BOLD*</b>	Optima	<b>Times Bold</b>
CRAW CLARENDON COND*	Goudy Extra Bold	<b>OPTIMA SEMIBOLD*</b>	TWENTIETH CENTURY*
			<b>UNIVERS 67*</b>

# Flat Face Cast Bronze Custom Letter Pricing

PRICE PER LETTER: Including standard mounting and pattern



LETTER HEIGHT - MAX DIMENSION	SIZE	DEPTH	1 - 5 SETS			6+ SETS		
			BRUSHED	OXIDIZED	POLISHED or PATINA	BRUSHED	OXIDIZED	POLISHED or PATINA
LETTER HEIGHT - MAX DIMENSION	4"	1/2"	\$110.20	\$126.73	\$143.26	\$103.90	\$119.49	\$135.07
	5	3/4	121.70	139.96	158.21	114.00	131.10	148.20
	6	3/4	130.60	150.19	169.78	122.90	141.34	159.77
	7	3/4	144.50	166.18	187.85	135.60	155.94	176.28
	8	3/4	162.20	186.53	210.86	152.00	174.80	197.60
	9	3/4	190.00	218.50	247.00	178.70	205.51	232.31
	10	1	214.10	246.22	278.33	201.50	231.73	261.95
	11	1	240.70	276.81	312.91	226.80	260.82	294.84
	12	1	268.60	308.89	349.18	252.10	289.92	327.73
	13	1	307.90	354.09	400.27	288.90	332.24	375.57
	14	1	345.90	397.79	449.67	325.60	374.44	423.28
	15	1-1/4	426.90	490.94	554.97	401.60	461.84	522.08
	16	1-1/4	457.40	526.01	594.62	429.50	493.93	558.35
	17	1-1/4	501.70	576.96	652.21	471.30	542.00	612.69
	18	1-1/2	542.30	623.65	704.99	509.30	585.70	662.09
	19	1-1/2	580.30	667.35	754.39	546.10	628.02	709.93
	20	1-1/2	618.30	711.05	803.79	581.50	668.73	755.95
	21	1-1/2	657.50	756.13	854.75	618.30	711.05	803.79
	22	1-1/2	695.50	799.83	904.15	653.70	751.76	849.81
	23	1-1/2	734.70	844.91	955.11	690.40	793.96	897.52
	24	1-1/2	781.60	898.84	1,016.08	734.70	844.91	955.11
	25	1-1/2	1,160.40	1,334.46	1,508.52	1,090.80	1,254.42	1,418.04
	26	1-1/2	1,255.50	1,443.83	1,632.15	1,180.70	1,357.81	1,534.91
	27	1-1/2	1,354.20	1,557.33	1,760.46	1,273.10	1,464.07	1,655.03
	28	1-1/2	1,454.40	1,672.56	1,890.72	1,366.90	1,571.94	1,776.97
	29	1-1/2	1,562.00	1,796.30	2,030.60	1,468.30	1,688.55	1,908.79
	30*	1-1/2	1,672.20	1,923.03	2,173.86	1,572.20	1,808.03	2,043.86
	31+	EMAIL FOR QUOTE						

\*Oversize charges will apply

**Note:**

Custom depths can be specified in 1/4" increments from 1/2" to 1-1/4", and in 1/2" increments from 1-1/2" to 3". Depths above 1-1/2" email for quote.

**Additional Pricing Notes:**

- Price includes stud mounts and installation pattern
- Lower case, where available, is 90% of the corresponding Upper Case price
- Small punctuation, such as a comma, period and dash are 33% of the Upper Case price

# Round or Prismatic Cast Bronze Custom Letter Pricing

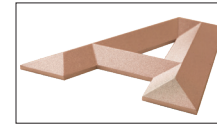
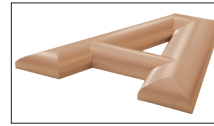

**PRICE PER LETTER: Including standard mounting and pattern**

LETTER HEIGHT - MAX DIMENSION	SIZE	DEPTH	1 SET			2 - 5 SETS			6+ SETS		
			BLASTED	OXIDIZED	POLISHED or PATINA	BLASTED	OXIDIZED	POLISHED or PATINA	BLASTED	OXIDIZED	POLISHED or PATINA
	4"	1/2"	\$231.90	\$266.69	\$301.47	\$210.40	\$241.96	\$273.52	\$190.00	\$218.50	\$247.00
	5	3/4	231.90	266.69	301.47	210.40	241.96	273.52	190.00	218.50	247.00
	6	3/4	231.90	266.69	301.47	210.40	241.96	273.52	190.00	218.50	247.00
	7	3/4	255.90	294.29	332.67	230.60	265.19	299.78	211.60	243.34	275.08
	8	3/4	281.30	323.50	365.69	253.40	291.41	329.42	230.60	265.19	299.78
	9	3/4	339.60	390.54	441.48	305.40	351.21	397.02	280.00	322.00	364.00
	10	1	378.80	435.62	492.44	340.80	391.92	443.04	310.40	356.96	403.52
	11	1	426.90	490.94	554.97	383.90	441.49	499.07	349.70	402.16	454.61
	12	1	475.00	546.25	617.50	429.50	493.93	558.35	390.30	448.85	507.39
	13	1	544.70	626.41	708.11	490.30	563.85	637.39	447.30	514.40	581.49
	14	1	614.40	706.56	798.72	553.60	636.64	719.68	504.30	579.95	655.59
	15	1-1/4	757.60	871.24	984.88	682.80	785.22	887.64	620.70	713.81	806.91
	16	1-1/4	810.70	932.31	1,053.91	731.00	840.65	950.30	665.10	764.87	864.63
	17	1-1/4	893.10	1,027.07	1,161.03	804.40	925.06	1,045.72	733.50	843.53	953.55
	18	1-1/2	961.50	1,105.73	1,249.95	865.30	995.10	1,124.89	788.00	906.20	1,024.40
	19	1-1/2	1,028.70	1,183.01	1,337.31	926.10	1,065.02	1,203.93	843.80	970.37	1,096.94
	20	1-1/2	1,102.10	1,267.42	1,432.73	992.00	1,140.80	1,289.60	903.30	1,038.80	1,174.29
	21	1-1/2	1,169.30	1,344.70	1,520.09	1,052.80	1,210.72	1,368.64	959.00	1,102.85	1,246.70
	22	1-1/2	1,237.70	1,423.36	1,609.01	1,113.60	1,280.64	1,447.68	1,014.80	1,167.02	1,319.24
	23	1-1/2	1,308.70	1,505.01	1,701.31	1,178.10	1,354.82	1,531.53	1,073.00	1,233.95	1,394.90
	24	1-1/2	1,389.70	1,598.16	1,806.61	1,250.30	1,437.85	1,625.39	1,140.10	1,311.12	1,482.13
	25	1-1/2	1,524.00	1,752.60	1,981.20	1,372.00	1,577.80	1,783.60	1,249.10	1,436.47	1,623.83
	26	1-1/2	1,765.90	2,030.79	2,295.67	1,589.80	1,828.27	2,066.74	1,446.70	1,663.71	1,880.71
	27	1-1/2	2,004.10	2,304.72	2,605.33	1,802.70	2,073.11	2,343.51	1,643.00	1,889.45	2,135.90
	28	1-1/2	2,180.20	2,507.23	2,834.26	1,961.10	2,255.27	2,549.43	1,787.50	2,055.63	2,323.75
	29	1-1/2	2,400.60	2,760.69	3,120.78	2,159.90	2,483.89	2,807.87	1,967.40	2,262.51	2,557.62
	30*	1-1/2	2,678.00	3,079.70	3,481.40	2,409.50	2,770.93	3,132.35	2,195.40	2,524.71	2,854.02
	31+		EMAIL FOR QUOTE								

\*Oversize charges will apply

**Note:**

Custom depths can be specified in 1/4" increments from 1/2" to 1-1/4", and in 1/2" increments from 1-1/2" to 3". Depths above 1-1/2" email for quote.

**Additional Pricing Notes:**

- Price includes stud mounts and installation pattern
- Lower case, where available, is 90% of the corresponding Upper Case price
- Small punctuation, such as a comma, period and dash are 33% of the Upper Case price



# Flat Face Cast Bronze Logo Pricing

**PRICE PER LOGO. Including standard mounting with pattern.**

Logos with 3 or more pieces may have additional charges.

SIZE	Up to																		
	12"	13"	14"	15"	16"	17"	18"	19"	20"	21"	22"	23"	24"	25"	26"	27"	28"	29"	30"*
Up to 12"	\$373	\$398	\$420	\$438	\$462	\$485	\$505	\$528	\$552	\$649	\$677	\$709	\$741	\$772	\$802	\$832	\$863	\$895	\$924
13	398	416	433	462	480	500	534	634	669	703	735	769	802	837	868	901	935	966	1,001
14	420	433	446	485	511	546	649	684	719	756	791	824	863	898	935	969	1,005	1,042	1,076
15	438	462	485	511	546	655	695	731	772	809	847	886	924	963	1,001	1,037	1,076	1,293	1,338
16	462	480	511	546	658	701	741	780	819	863	906	944	987	1,026	1,068	1,286	1,331	1,381	1,426
17	485	500	546	655	701	744	785	830	871	915	960	1,003	1,046	1,089	1,315	1,366	1,413	1,466	1,516
18	505	534	649	695	741	785	832	878	924	969	1,016	1,061	1,286	1,338	1,390	1,444	1,497	1,550	1,603
19	528	634	684	731	780	830	878	927	973	1,025	1,071	1,214	1,356	1,416	1,468	1,529	1,580	1,641	1,695
20	552	669	719	772	819	871	924	973	1,026	1,076	1,309	1,370	1,426	1,485	1,545	1,603	1,663	1,724	1,784
21	649	703	756	809	863	915	969	1,025	1,076	1,225	1,376	1,440	1,497	1,564	1,624	1,689	1,747	1,813	1,869
22	677	735	791	847	906	960	1,016	1,071	1,309	1,376	1,439	1,505	1,568	1,634	1,700	1,763	1,831	1,895	1,960
23	709	769	824	886	944	1,003	1,061	1,214	1,370	1,440	1,505	1,577	1,640	1,713	1,779	1,850	1,914	1,986	2,049
24	741	802	863	924	987	1,046	1,286	1,356	1,426	1,497	1,568	1,640	1,708	1,784	1,853	1,925	1,996	2,068	2,139
25	772	837	898	963	1,026	1,089	1,338	1,416	1,485	1,564	1,634	1,713	1,784	1,860	1,930	2,009	2,079	2,159	2,227
26	802	868	935	1,001	1,068	1,315	1,390	1,468	1,545	1,624	1,700	1,779	1,853	1,930	2,007	2,085	2,163	2,238	2,316
27	832	901	969	1,037	1,286	1,366	1,444	1,529	1,603	1,689	1,763	1,850	1,925	2,009	2,085	2,159	2,244	2,306	2,406
28	863	935	1,005	1,076	1,331	1,413	1,497	1,580	1,663	1,747	1,831	1,914	1,996	2,079	2,163	2,244	2,328	2,413	2,493
29	895	966	1,042	1,293	1,381	1,466	1,550	1,641	1,724	1,813	1,895	1,986	2,068	2,159	2,238	2,306	2,413	2,455	2,583
30*	924	1,001	1,076	1,338	1,426	1,516	1,603	1,695	1,784	1,869	1,960	2,049	2,139	2,227	2,316	2,406	2,493	2,583	2,672
31*	955	1,033	1,290	1,383	1,474	1,566	1,658	1,755	1,843	1,940	2,024	2,121	2,209	2,306	2,393	2,455	2,578	2,606	2,762
32*	987	1,068	1,331	1,426	1,524	1,616	1,708	1,806	1,899	1,996	2,089	2,186	2,279	2,373	2,468	2,565	2,660	2,752	2,850
33*	1,016	1,100	1,376	1,471	1,568	1,669	1,763	1,867	1,960	2,063	2,153	2,259	2,353	2,455	2,546	2,606	2,744	2,813	2,937
34*	1,046	1,315	1,413	1,516	1,616	1,718	1,819	1,919	2,018	2,120	2,222	2,322	2,423	2,523	2,623	2,724	2,826	2,928	3,027
35*	1,076	1,354	1,455	1,562	1,663	1,767	1,869	1,980	2,079	2,189	2,287	2,396	2,493	2,606	2,705	2,813	2,907	2,940	3,116
36*	1,286	1,390	1,497	1,603	1,708	1,819	1,925	2,033	2,139	2,244	2,353	2,459	2,565	2,672	2,778	2,886	2,992	3,098	3,205
37*	1,317	1,421	1,524	1,655	1,722	1,859	1,936	2,058	2,158	2,261	2,401	2,485	2,591	2,753	2,804	2,899	3,027	3,158	3,255
38*	1,327	1,428	1,535	1,678	1,728	1,868	1,942	2,069	2,169	2,269	2,412	2,496	2,605	2,768	2,817	2,908	3,037	3,164	3,266
40*	1,378	1,471	1,571	1,728	1,797	1,948	2,018	2,105	2,298	2,461	2,639	2,723	2,751	2,908	3,081	3,244	3,266	3,366	3,381
42*	1,428	1,519	1,622	1,769	1,868	1,984	2,083	2,251	2,412	2,544	2,664	2,829	2,984	3,165	3,338	3,463	3,571	3,636	3,680
44*	1,513	1,564	1,670	1,797	1,960	2,035	2,175	2,304	2,461	2,595	2,711	2,868	3,037	3,344	3,507	3,622	3,706	3,863	3,991
46*	1,583	1,677	1,750	1,868	2,018	2,098	2,255	2,395	2,524	2,705	2,874	3,088	3,293	3,468	3,628	3,713	3,773	3,953	4,060
48*	1,656	1,728	1,862	1,954	2,126	2,175	2,326	2,482	2,595	2,837	2,908	3,305	3,366	3,552	3,722	3,857	3,920	4,019	4,124
49+	EMAIL FOR QUOTE																		

**Price As Listed**



Brushed

**Add 15%**



#4 Brushed



Light Oxidized

**Add 30%**

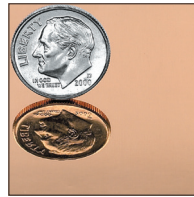

Polished

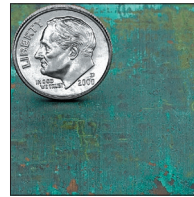

Verde Patina



Turquoise Patina

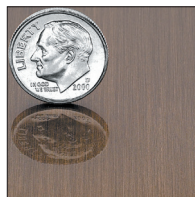

Oxidized

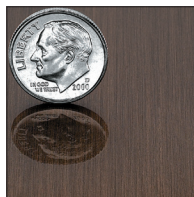

Dark Oxidized



BLADORA  
#4

## UNMATCHED FIT AND FINISH

Large or small, Gemini's fabricated metal letters and logos offer the scale and dramatic return depth you want with a precision fit and finish you won't find elsewhere. Our exclusive stainless steel manufacturing technology allows virtually any letter stroke-to-width ratio, and our aluminum letters and logos are precision MIG welded.



## FABRICATED METAL

Virtually unlimited  
design potential

Expertly crafted to  
exacting requirements

Sizes ranging from  
2 inch to 100+ inches

Multiple finish and  
return depths

Industry-leading  
lead times

### **DIMENSIONAL PRECISION**

Your most ambitious design aspirations can be realized with Gemini's fabricated metal letters and logos. Our precision manufacturing technology expands design possibilities in stainless steel, allowing for virtually any letter stroke-to-width ratio, letting you achieve delicate strokes as narrow as 3/8" paired with unprecedented return depths. Our aluminum fabrication capabilities are no less impressive, offering a made-to-order solution for larger scale letter and logo applications up to 120" high in one piece.

Like all Gemini products, we build with sustainability in mind, with the highest quality metals featuring 20% to 40% recycled materials, and 100% recycling of all scrap and trim produced.



#### WHEN ORDERING

PLEASE SPECIFY:

- Install Environment
- Size (Height)
- Finish Selection
- Vector Art or Standard Font
- Depth
- Install Method



## Standard: Painted Colors

 5687 White Approx PMS White	 2718 Ivory Approx PMS 7499	 4660 Desert Sand Approx PMS 7506	 0209 Grey Approx PMS 423	 4310 Dove Grey Approx PMS 431	 8090 Safety Green Approx PMS 809	 2037 Lemon Yellow Approx PMS 102	 2000 Yellow Approx PMS 108
 0217 Citrus Yellow Approx PMS 606	 0218 Sundance Yellow Approx PMS 116	 0254 Mango Approx PMS 137	 2119 Orange Approx PMS 21	 2662 Red-Orange Approx PMS 485	 0256 Rampart Orange Approx PMS 172	 2793 Red Approx PMS 185	 1875 Brick Red Approx PMS 7623
 2280 Black Cherry Approx PMS 1817	 2240 Maroon Approx PMS 202	 2410 Magenta Approx PMS 241	 2287 Purple Approx PMS 2695	 0246 Violet Toner Approx PMS 2725	 2767 Midnight Blue Approx PMS 5395	 2050 Dark Blue Approx PMS 281	 2860 Medium Blue Approx PMS 286
 3000 Blue Approx PMS 300	 2648 Light Blue Approx PMS 2995	 5425 Marine Reef Blue Approx PMS 5425	 3210 Teal Blue Approx PMS 321	 3555 Spring Green Approx PMS 355	 0222 Emerald Green Approx PMS 356	 0259 Federal Green Approx PMS 350	 2108 Light Green Approx PMS 3415
 2030 Dark Green Approx PMS 3435	 2162 Hunter Green Approx PMS 3308	 0400 Brilliant Gold Approx PMS 7556	 2756 Metallic Gold* Approx PMS 465	 0401 Aztec Gold Approx PMS 2317	 0253 Copper Approx PMS 7600	 0402 Aztec Copper Approx PMS 7599	 2418 Brown Approx PMS 476
 0312 Medium Bronze* Approx PMS 2335	 0314 Old Copper* Approx PMS 2334	 3130 Duranodic Bronze* Approx PMS 2336	 1315 Dark Oxide Approx PMS 447	 8886 Metallic Silver* Approx PMS 3435	 2025 Black Approx PMS Black		

### Custom Paint Color:

It's easy to request custom color matching! Simply tell us the paint number or name and brand of paint you'd like us to match (e.g. PMS 186 or Sherwin-Williams Boathouse Blue) and we will obtain a mixing formula at no cost to you.

Don't have a paint name or number and still need a color exactly matched? Please send us a sample (sample item must be at least 3" x 3") and our paint lab will run it through an exacting color match process. Exact color matching from a sample is \$200.



### Stainless Steel Alloy 304:

Vertical grain is standard on all fabricated letters & logos. Horizontal grain can be requested. Mixed face and return finishes - email for quote.



Brushed



#4 Brushed



Polished



Random Arc

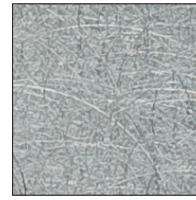

Orbital

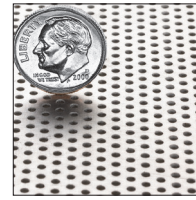

Perforated

### Titanium Coated 304 Stainless Steel



Brushed Gold



Brushed Copper



Brushed Bronze



Brushed Black

### Stainless Steel Alloy 316



Brushed



#4 Brushed



Polished



Polished Gold

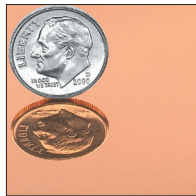

Polished Copper



Polished Bronze



Polished Black

### Stainless Steel Letter Construction

18 or 16 gauge face



24 gauge return - up to 24" high  
22 gauge return - over 24" high

24 gauge = .0239"    22 gauge = .0299"  
18 gauge = .0478"    16 gauge = .0598"

Precision welded/soldered construction

### Lighting Stainless Steel

**HALO-LIT**

See page xxx for Halo-Lit Stainless Steel pricing

**FACE-LIT**

See page xxx for Face-Lit Stainless Steel pricing

## Aluminum: Alloy 5052



Brushed

### Anodized Aluminum:

Anodized finishes are not just coatings... they are a part of the finished aluminum letter. Anodizing is an electrochemical process that hardens aluminum and allows it to be colorized. We perform our own anodizing to ensure your letters within the same order have color consistency and are delivered to you within days. Some of the many reasons to have Gemini anodize your aluminum letters include: Abrasion and weather resistant; Beautiful finish; Increases hardness and durability; Will not crack or peel; Unaffected by sunlight / UV; Environmentally friendly; Cost effective. Note: Colors may vary slightly from order to order.

## Aluminum: Anodized Finishes



Clear

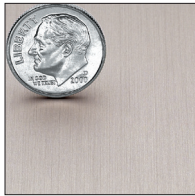

Champagne



Gold

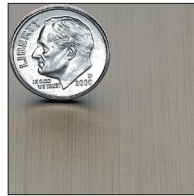

Light Bronze

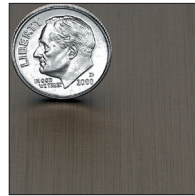

Medium Bronze

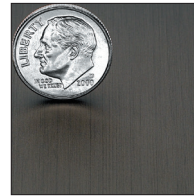

Dark Bronze

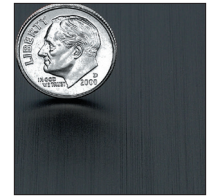

Black

## Aluminum Letter Construction

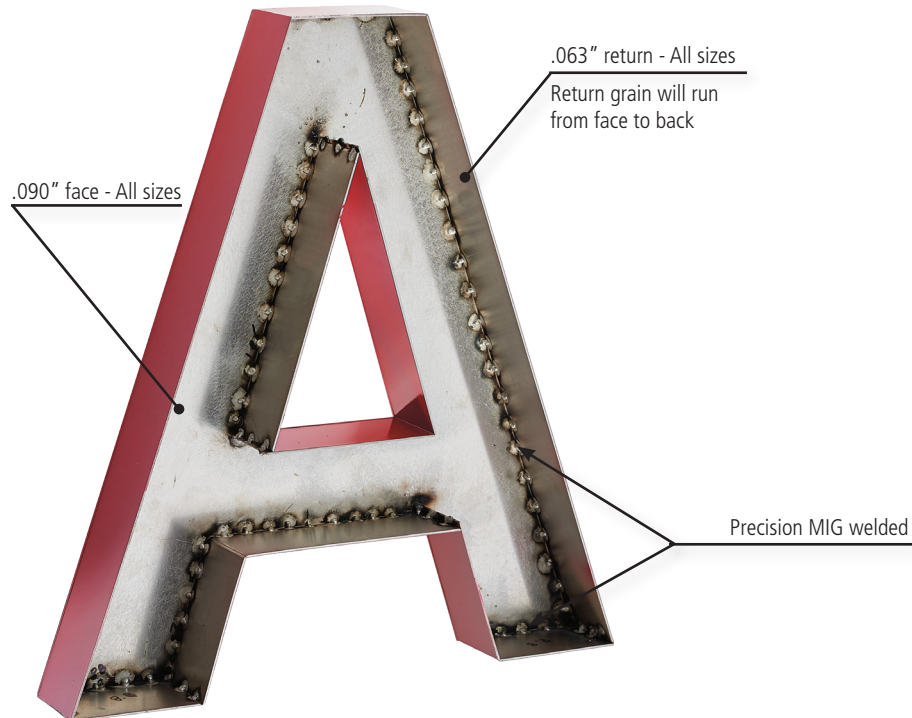

## Lighting Aluminum



See page xxx for Halo-Lit Aluminum Fabricated



See page xxx for Face-Lit Aluminum Fabricated

Standard Mounting Method:

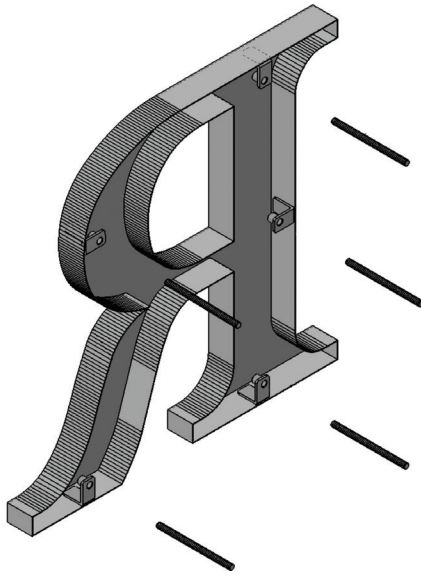

**Stud Mount**

*Backs of letters and logos have hardware that is drilled and tapped to received threaded studs for mounting. Optional alignment for brick, block or rails available.*

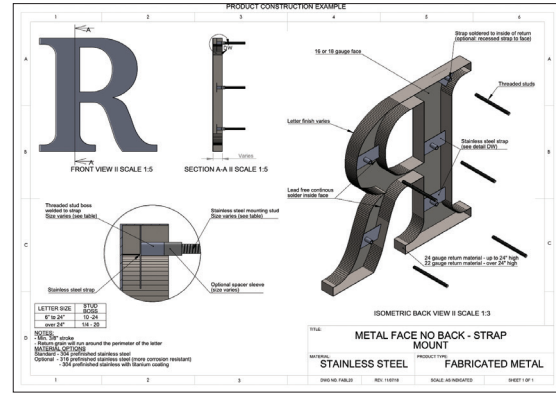

**CAD Drawings:**

A complete list of downloadable PDFs can be found by clicking on the CAD drawing above.

Optional Mounting Methods:

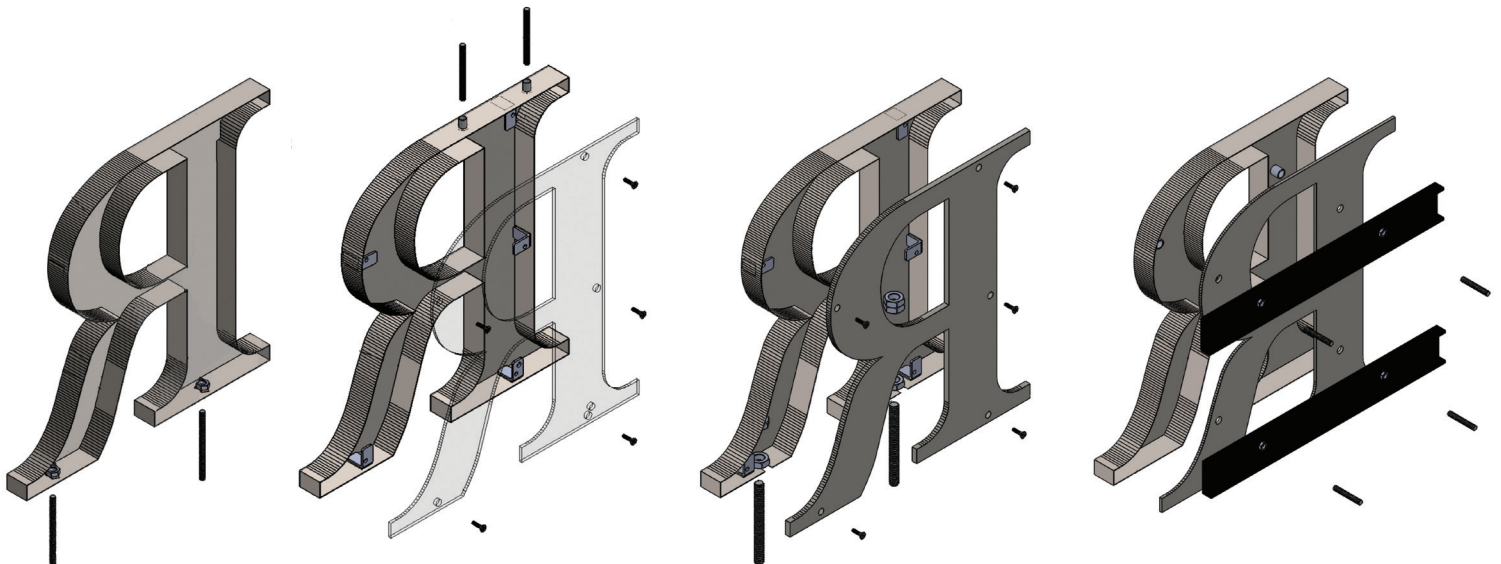

**Bottom or Top Stud  
No Back  
(Up to 8" - Add 15%)**

**Bottom or Top Stud  
w/Back  
(Over 8" - Call for quote)**

**Bottom or Top Stud  
w/Thick Back  
(Over 8" - Call for quote)**

**Double Rail Mount  
(Call for quote)**



# Fabricated Stainless Steel - Without Back

## PRICE PER LETTER INCLUDES STANDARD MOUNTING AND PATTERN



Brushed



Painted

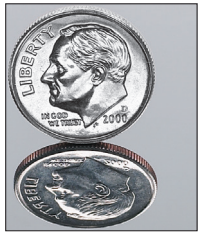

Polished

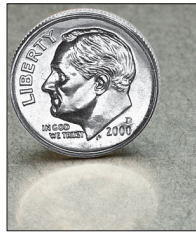

Vibration

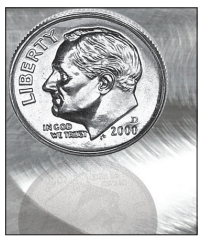

Random Arc



Perforated

LETTER HEIGHT - MAX DIMENSION

SIZE	3/8" DEEP	1/2" DEEP	3/4" DEEP	1" DEEP	1-1/2" DEEP	2" DEEP	2-1/2" DEEP	3" DEEP	4" DEEP	5" DEEP	6" DEEP
2"	\$57	\$57	\$62	\$64	\$72						
3	57	57	62	64	72						
4	57	57	62	64	72						
5		57	62	64	72						
6		61	63	68	76	\$88					
7		66	68	74	82	95					
8		70	74	82	88	101					
9			79	91	100	117	\$125	\$131	\$145		
10			85	100	108	125	133	139	153		
11			92	108	117	131	140	147	163		
12			99	115	124	141	151	159	177		
13				125	134	156	166	174	192	\$206	
14				136	150	171	183	193	215	232	
15				150	159	185	198	208	230	247	
16				158	171	197	211	223	241	258	\$280
17				166	179	209	224	236	257	276	300
18				179	194	226	241	253	269	287	312
19				194	205	241	257	271	281	299	324
20				201	220	257	273	286	296	309	335
21				214	234	267	278	287	308	319	346
22				230	252	282	294	303	322	335	362
23				249	275	308	319	328	350	361	388
24				276	309	342	354	364	386	399	431
25				302	340	370	382	392	414	433	467
26				330	364	389	402	412	436	468	508
27				349	379	404	418	429	453	486	527
28				362	392	418	433	445	471	505	547
29				376	407	433	448	461	488	522	567
30*				388	421	447	463	476	505	541	587
31*				404	437	464	480	494	522	560	608
32*				419	454	480	496	510	541	579	628
33*				436	472	499	518	534	562	602	653
34*				453	490	517	535	551	583	625	678
35*				471	509	537	556	572	606	650	705
36*				489	529	557	576	593	629	675	732
37"+	EMAIL FOR QUOTE										

### Pricing Notes:

- Price includes stud mount and installation pattern
- Lower case is 90% of the corresponding Upper Case price
- Small punctuation, such as a comma, period and dash are 33% of the Upper Case price
- Block, serif & script styles - SAME PRICE
- Returns painted different color than face add 15%

\*Oversize charges will apply

### OPTIONAL FINISHES - ADD 30%

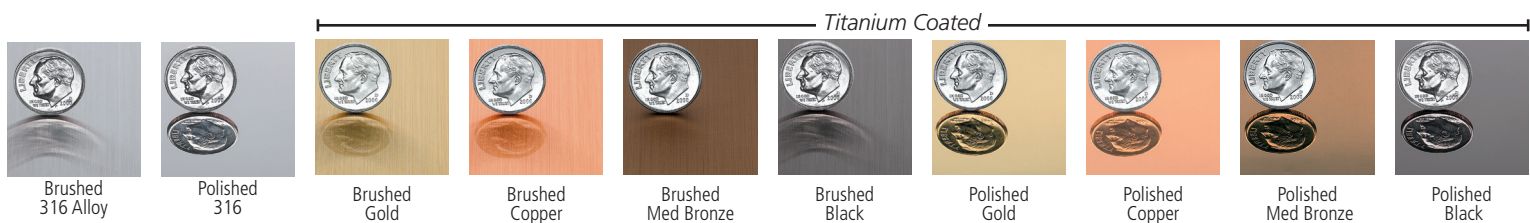

# Fabricated Stainless Steel - With Metal Back

PRICE PER LETTER INCLUDES STANDARD MOUNTING AND PATTERN



Brushed

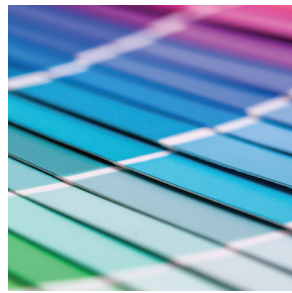

Painted



Polished



Vibration



Random Arc

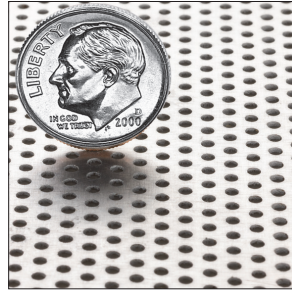

Perforated

LETTER HEIGHT - MAX DIMENSION

SIZE	1" DEEP	1-1/2" DEEP	2" DEEP	2-1/2" DEEP	3" DEEP	4" DEEP	5" DEEP	6" DEEP
6"	\$86	\$95	\$110					
7	93	104	119					
8	99	110	126					
9	112	123	140	\$152	\$161	\$180		
10	125	135	154	166	175	190		
11	134	145	163	174	182	202		
12	144	157	175	188	198	220		
13	154	168	192	204	214	237	\$257	
14	169	186	212	227	239	266	288	
15	186	197	229	244	257	284	306	
16	195	209	244	260	274	295	319	\$347
17	206	222	258	276	292	317	342	375
18	222	241	280	298	313	329	353	385
19	241	256	298	317	334	346	367	398
20	255	273	314	332	348	363	382	410
21	267	291	324	338	350	375	393	420
22	284	307	339	354	366	392	412	439
23	301	328	357	372	385	413	435	464
24	335	366	393	407	418	445	464	511
25	368	402	424	440	453	480	504	554
26	395	429	457	476	492	516	551	598
27	422	457	484	503	520	556	591	637
28	448	485	507	527	545	584	625	666
29	466	503	526	547	565	604	650	698
30*	484	523	545	566	585	624	670	720
31*			564	587	607	648	695	746
32*			582	606	628	673	722	777
33*			602	628	651	698	750	808
34*			623	649	673	726	779	839
35*			642	671	698	754	809	874
36*			667	697	725	782	840	908
37"+	EMAIL FOR QUOTE							

\*Oversize charges will apply

**Pricing Notes:**

- Price includes stud mount and installation pattern
- Lower case is 90% of the corresponding Upper Case price
- Small punctuation, such as a comma, period and dash are 33% of the Upper Case price
- Block, serif & script styles - SAME PRICE
- Returns painted different color than face add 15%

**OPTIONAL FINISHES - ADD 30%**



Brushed 316 Alloy

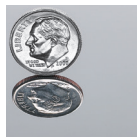

Polished 316

Titanium Coated



Brushed Gold



Brushed Copper

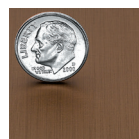

Brushed Med Bronze



Brushed Black

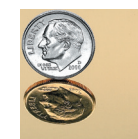

Polished Gold

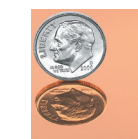

Polished Copper

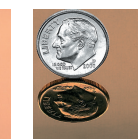

Polished Med Bronze

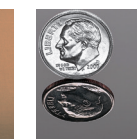

Polished Black

# Your Logo 1" Deep #304 Stainless Steel without Back

**PRICE PER LOGO.** Including standard mounting with pattern.

*Logos smaller than 10" x 10" or with more than 3 pieces email for quote*

SIZE	10"	11"	12"	13"	14"	15"	16"	17"	18"	19"*	20"*	21"*	22"*	23"*	24"*	26"*	28"*	30"*	32"*	34"*	36"*
10"	\$65.02	\$71.52	\$78.02	\$84.53	\$91.03	\$97.53	\$104.03	\$110.53	\$117.03	\$123.54	\$130.04	\$136.54	\$143.04	\$149.54	\$156.04	\$169.05	\$182.05	\$195.05	\$221.71	\$221.06	\$234.06
11	71.52	78.67	85.83	92.98	100.13	107.28	114.43	121.58	128.74	135.89	143.04	150.19	157.34	164.50	171.65	185.95	200.25	214.56	241.86	243.16	257.47
12	78.02	85.83	93.63	101.43	109.23	117.03	124.84	132.64	140.44	148.24	156.04	163.85	171.65	179.45	187.25	202.85	218.46	234.06	262.02	265.27	280.87
13	84.53	92.98	101.43	109.88	118.33	126.79	135.24	143.69	152.14	160.59	169.05	177.50	185.95	194.40	202.85	219.76	236.66	253.57	282.17	287.38	304.28
14	91.03	100.13	109.23	118.33	127.44	136.54	145.64	154.74	163.85	172.95	182.05	191.15	200.25	209.36	218.46	236.66	254.87	273.07	302.33	309.48	327.69
15	97.53	107.28	117.03	126.79	136.54	146.29	156.04	165.80	175.55	185.30	195.05	204.81	214.56	224.31	234.06	253.57	273.07	292.58	322.48	331.59	351.09
16	104.03	114.43	124.84	135.24	145.64	156.04	166.45	176.85	187.25	197.65	208.06	218.46	228.86	239.26	249.67	270.47	291.28	312.08	342.64	353.69	374.50
17	110.53	121.58	132.64	143.69	154.74	165.80	176.85	187.90	198.95	210.01	221.06	232.11	243.16	254.22	265.27	287.38	309.48	331.59	362.79	375.80	397.90
18	117.03	128.74	140.44	152.14	163.85	175.55	187.25	198.95	210.66	222.36	234.06	245.77	257.47	269.17	280.87	304.28	327.69	351.09	382.95	397.90	421.31
19	123.54	135.89	148.24	160.59	172.95	185.30	197.65	210.01	222.36	234.71	247.07	259.42	271.77	284.12	296.48	321.18	345.89	370.60	403.10	420.01	444.71
20	130.04	143.04	156.04	169.05	182.05	195.05	208.06	221.06	234.06	247.07	260.07	273.07	286.08	299.08	312.08	338.09	364.09	390.10	423.26	442.11	468.12
21	136.54	150.19	163.85	177.50	191.15	204.81	218.46	232.11	245.77	259.42	273.07	286.73	300.38	314.03	327.69	354.99	382.30	409.61	443.41	464.22	491.53
22	143.04	157.34	171.65	185.95	200.25	214.56	228.86	243.16	257.47	271.77	286.08	300.38	314.68	328.99	343.29	371.90	400.50	429.11	463.57	486.32	514.93
23	149.54	164.50	179.45	194.40	209.36	224.31	239.26	254.22	269.17	284.12	299.08	314.03	328.99	343.94	358.89	388.80	418.71	448.62	483.72	508.43	538.34
24	156.04	171.65	187.25	202.85	218.46	234.06	249.67	265.27	280.87	296.48	312.08	327.69	343.29	358.89	374.50	405.70	436.91	468.12	503.88	530.54	561.74
25	162.54	178.80	195.05	211.31	227.56	243.81	260.07	276.32	292.58	308.83	325.08	341.34	357.59	373.85	390.10	422.61	455.12	487.62	524.03	552.64	585.15
26	169.05	185.95	202.85	219.76	236.66	253.57	270.47	287.38	304.28	321.18	338.09	354.99	371.90	388.80	405.70	439.51	473.32	507.13	544.19	574.75	608.55
27	175.55	193.10	210.66	228.21	245.77	263.32	280.87	298.43	315.98	333.54	351.09	368.65	386.20	403.75	421.31	456.42	491.53	526.63	564.34	596.85	631.96
28	182.05	200.25	218.46	236.66	254.87	273.07	291.28	309.48	327.69	345.89	364.09	382.30	400.50	418.71	436.91	473.32	509.73	546.14	584.50	618.96	655.37
29	188.55	207.41	226.26	245.12	263.97	282.82	301.68	320.53	339.39	358.24	377.10	395.95	414.81	433.66	452.52	490.23	527.93	565.64	604.65	641.06	678.77
30*	195.05	214.56	234.06	253.57	273.07	292.58	312.08	331.59	351.09	370.60	390.10	409.61	429.11	448.62	468.12	507.13	546.14	585.15	624.81	663.17	702.18
31*	201.55	221.71	241.86	262.02	282.17	302.33	322.48	342.64	362.79	382.95	403.10	423.26	443.41	463.57	483.72	524.03	564.34	604.65	644.96	685.27	725.58
32*	208.06	228.86	249.67	270.47	291.28	312.08	332.89	353.69	374.50	395.30	416.11	436.91	457.72	478.52	499.33	540.94	582.55	624.16	665.77	707.38	748.99
33*	214.56	236.01	257.47	278.92	300.38	321.83	343.29	364.74	386.20	407.66	429.11	450.57	472.02	493.48	514.93	557.84	600.75	643.66	686.57	729.48	772.40
34*	221.06	243.16	265.27	287.38	309.48	331.59	353.69	375.80	397.90	420.01	442.11	464.22	486.32	508.43	530.54	574.75	618.96	663.17	707.38	751.59	795.80
35*	227.56	250.32	273.07	295.83	318.58	341.34	364.09	386.85	409.61	432.36	455.12	477.87	500.63	523.38	546.14	591.65	637.16	682.67	728.18	773.70	819.21
36*	234.06	257.47	280.87	304.28	327.69	351.09	374.50	397.90	421.31	444.71	468.12	491.53	514.93	538.34	561.74	608.55	655.37	702.18	748.99	795.80	842.61
37+	EMAIL FOR QUOTE																				

\*Oversize charges will apply

## PRICE AS LISTED

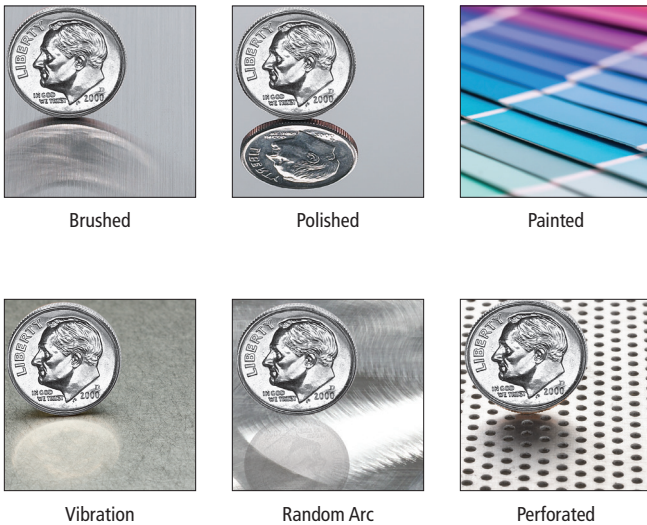

## OPTIONAL FINISHES - ADD 30%





# Your Logo 1" Deep #304 Stainless Steel with Back

**PRICE PER LOGO.** Including standard mounting with pattern.

*Logos smaller than 10" x 10" or with more than 3 pieces email for quote*

SIZE	10"	11"	12"	13"	14"	15"	16"	17"	18"	19"*	20"*	21"*	22"*	23"*	24"*	26"*	28"*	30"*	32"*	34"*	36"*
10"	\$75.47	\$83.02	\$90.56	\$98.11	\$105.66	\$113.20	\$120.75	\$128.30	\$135.84	\$143.39	\$150.93	\$158.48	\$166.03	\$173.57	\$181.12	\$196.21	\$211.31	\$226.40	\$241.49	\$256.59	\$271.68
11	83.02	91.32	99.62	107.92	116.22	124.52	132.82	141.12	149.43	157.73	166.03	174.33	182.63	190.93	199.23	215.83	232.44	249.04	265.64	282.24	298.85
12	90.56	99.62	108.67	117.73	126.79	135.84	144.90	153.95	163.01	172.07	181.12	190.18	199.23	208.29	217.34	235.46	253.57	271.68	289.79	307.90	326.01
13	98.11	107.92	117.73	127.54	137.35	147.16	156.97	166.78	176.59	186.40	196.21	206.02	215.83	225.65	235.46	255.08	274.70	294.32	313.94	333.56	353.18
14	105.66	116.22	126.79	137.35	147.92	158.48	169.05	179.61	190.18	200.74	211.31	221.87	232.44	243.00	253.57	274.70	295.83	316.96	338.09	359.22	380.35
15	113.20	124.52	135.84	147.16	158.48	169.80	181.12	192.44	203.76	215.08	226.40	237.72	249.04	260.36	271.68	294.32	316.96	339.60	362.24	384.88	407.52
16	120.75	132.82	144.90	156.97	169.05	181.12	193.20	205.27	217.34	229.42	241.49	253.57	265.64	277.72	289.79	313.94	338.09	362.24	386.39	410.53	434.68
17	128.30	141.12	153.95	166.78	179.61	192.44	205.27	218.10	230.93	243.76	256.59	269.42	282.24	295.07	307.90	333.56	359.22	384.88	410.53	436.19	461.85
18	135.84	149.43	163.01	176.59	190.18	203.76	217.34	230.93	244.51	258.10	271.68	285.26	298.85	312.43	326.01	353.18	380.35	407.52	434.68	461.85	489.02
19	143.39	157.73	172.07	186.40	200.74	215.08	229.42	243.76	258.10	272.43	286.77	301.11	315.45	329.79	344.13	372.80	401.48	430.16	458.83	487.51	516.19
20	150.93	166.03	181.12	196.21	211.31	226.40	241.49	256.59	271.68	286.77	301.86	316.96	332.05	347.14	362.24	392.42	422.61	452.79	482.98	513.17	543.35
21	158.48	174.33	190.18	206.02	221.87	237.72	253.57	269.42	285.26	301.11	316.96	332.81	348.65	364.50	380.35	412.04	443.74	475.43	507.13	538.83	570.52
22	166.03	182.63	199.23	215.83	232.44	249.04	265.64	282.24	298.85	315.45	332.05	348.65	365.26	381.86	398.46	431.66	464.87	498.07	531.28	564.48	597.69
23	173.57	190.93	208.29	225.65	243.00	260.36	277.72	295.07	312.43	329.79	347.14	364.50	381.86	399.21	416.57	451.29	486.00	520.71	555.43	590.14	624.86
24	181.12	199.23	217.34	235.46	253.57	271.68	289.79	307.90	326.01	344.13	362.24	380.35	398.46	416.57	434.68	470.91	507.13	543.35	579.58	615.80	652.02
25	188.67	207.53	226.40	245.27	264.13	283.00	301.86	320.73	339.60	358.46	377.33	396.20	415.06	433.93	452.79	490.53	528.26	565.99	603.72	641.46	679.19
26	196.21	215.83	235.46	255.08	274.70	294.32	313.94	333.56	353.18	372.80	392.42	412.04	431.66	451.29	470.91	510.15	549.39	588.63	627.87	667.12	706.36
27	203.76	224.14	244.51	264.89	285.26	305.64	326.01	346.39	366.76	387.14	407.52	427.89	448.27	468.64	489.02	529.77	570.52	611.27	652.02	692.77	733.52
28	211.31	232.44	253.57	274.70	295.83	316.96	338.09	359.22	380.35	401.48	422.61	443.74	464.87	486.00	507.13	549.39	591.65	633.91	676.17	718.43	760.69
29	218.85	240.74	262.62	284.51	306.39	328.28	350.16	372.05	393.93	415.82	437.70	459.59	481.47	503.36	525.24	569.01	612.78	656.55	700.32	744.09	787.86
30*	226.40	249.04	271.68	294.32	316.96	339.60	362.24	384.88	407.52	430.16	452.79	475.43	498.07	520.71	543.35	588.63	633.91	679.19	724.47	769.75	815.03
31*	233.95	257.34	280.73	304.13	327.52	350.92	374.31	397.71	421.10	444.49	467.89	491.28	514.68	538.07	561.46	608.25	655.04	701.83	748.62	795.41	842.19
32*	241.49	265.64	289.79	313.94	338.09	362.24	386.39	410.53	434.68	458.83	482.98	507.13	531.28	555.43	579.58	627.87	676.17	724.47	772.77	821.06	869.36
33*	249.04	273.94	298.85	323.75	348.65	373.56	398.46	423.36	448.27	473.17	498.07	522.98	547.88	572.78	597.69	647.49	697.30	747.11	796.92	846.72	896.53
34*	256.59	282.24	307.90	333.56	359.22	384.88	410.53	436.19	461.85	487.51	513.17	538.83	564.48	590.14	615.80	667.12	718.43	769.75	821.06	872.38	923.70
35*	264.13	290.55	316.96	343.37	369.78	396.20	422.61	449.02	475.43	501.85	528.26	554.67	581.09	607.50	633.91	686.74	739.56	792.39	845.21	898.04	950.86
36*	271.68	298.85	326.01	353.18	380.35	407.52	434.68	461.85	489.02	516.19	543.35	570.52	597.69	624.86	652.02	706.36	760.69	815.03	869.36	923.70	978.03
37+	EMAIL FOR QUOTE																				

\*Oversize charges will apply

## PRICE AS LISTED



Brushed



Polished

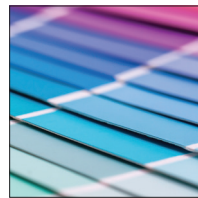

Painted

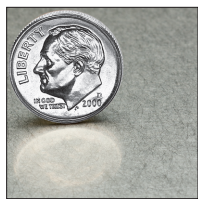

Vibration



Random Arc

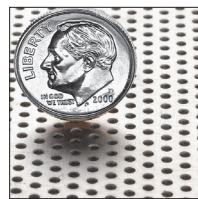

Perforated

## OPTIONAL FINISHES - ADD 30%

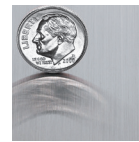

Brushed 316 Alloy

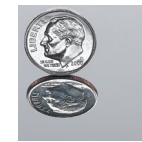

Polished 316 Alloy



Brushed Gold

Polished Gold

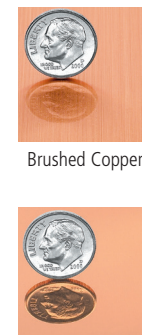

Brushed Copper

Polished Copper

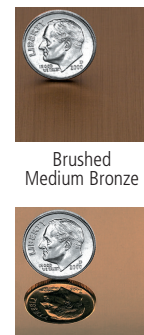

Brushed Medium Bronze

Polished Medium Bronze

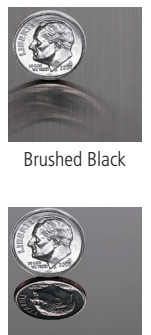

Brushed Black

Polished Black

# Your Logo 1-1/2" Deep #304 Stainless Steel without Back

**PRICE PER LOGO.** Including standard mounting with pattern.

*Logos smaller than 10" x 10" or with more than 3 pieces email for quote*

SIZE	10"	11"	12"	13"	14"	15"	16"	17"	18"	19"*	20"*	21"*	22"*	23"*	24"*	26"*	28"*	30"*	32"*	34"*	36"*
10"	\$74.78	\$82.25	\$89.73	\$97.21	\$104.69	\$112.16	\$119.64	\$127.11	\$134.59	\$142.08	\$149.55	\$157.03	\$164.50	\$171.98	\$179.45	\$194.41	\$209.36	\$224.31	\$254.97	\$254.22	\$269.17
11	82.25	90.48	98.71	106.93	115.15	123.38	131.60	139.82	148.06	156.28	164.50	172.72	180.95	189.18	197.40	213.85	230.29	246.75	278.14	279.64	296.10
12	89.73	98.71	107.68	116.65	125.62	134.59	143.57	152.54	161.51	170.48	179.45	188.43	197.40	206.37	215.34	233.28	251.23	269.17	301.33	305.07	323.01
13	97.21	106.93	116.65	126.37	136.08	145.81	155.53	165.25	174.97	184.68	194.41	204.13	213.85	223.56	233.28	252.73	272.16	291.61	324.50	330.49	349.93
14	104.69	115.15	125.62	136.08	146.56	157.03	167.49	177.96	188.43	198.90	209.36	219.83	230.29	240.77	251.23	272.16	293.11	314.04	347.68	355.91	376.85
15	112.16	123.38	134.59	145.81	157.03	168.24	179.45	190.67	201.89	213.10	224.31	235.54	246.75	257.96	269.17	291.61	314.04	336.47	370.86	381.33	403.76
16	119.64	131.60	143.57	155.53	167.49	179.45	191.42	203.38	215.34	227.30	239.27	251.23	263.19	275.15	287.13	311.05	334.98	358.90	394.04	406.75	430.68
17	127.11	139.82	152.54	165.25	177.96	190.67	203.38	216.09	228.80	241.52	254.22	266.93	279.64	292.36	305.07	330.49	355.91	381.33	417.21	432.17	457.59
18	134.59	148.06	161.51	174.97	188.43	201.89	215.34	228.80	242.26	255.72	269.17	282.64	296.10	309.55	323.01	349.93	376.85	403.76	440.40	457.59	484.51
19	142.08	156.28	170.48	184.68	198.90	213.10	227.30	241.52	255.72	269.92	284.14	298.34	312.54	326.74	340.96	369.36	397.78	426.19	463.57	483.02	511.42
20	149.55	164.50	179.45	194.41	209.36	224.31	239.27	254.22	269.17	284.14	299.09	314.04	329.00	343.95	358.90	388.81	418.71	448.62	486.75	508.43	538.34
21	157.03	172.72	188.43	204.13	219.83	235.54	251.23	266.93	282.64	298.34	314.04	329.74	345.44	361.14	376.85	408.24	439.65	471.06	509.93	533.86	565.26
22	164.50	180.95	197.40	213.85	230.29	246.75	263.19	279.64	296.10	312.54	329.00	345.44	361.89	378.34	394.79	427.69	460.58	493.48	533.11	559.27	592.17
23	171.98	189.18	206.37	223.56	240.77	257.96	275.15	292.36	309.55	326.74	343.95	361.14	378.34	395.54	412.73	447.12	481.52	515.92	556.28	584.70	619.10
24	179.45	197.40	215.34	233.28	251.23	269.17	287.13	305.07	323.01	340.96	358.90	376.85	394.79	412.73	430.68	466.56	502.45	538.34	579.47	610.13	646.01
25	186.93	205.62	224.31	243.01	261.70	280.39	299.09	317.77	336.47	355.16	373.85	392.55	411.23	429.93	448.62	486.01	523.39	560.77	602.64	635.54	672.93
26	194.41	213.85	233.28	252.73	272.16	291.61	311.05	330.49	349.93	369.36	388.81	408.24	427.69	447.12	466.56	505.44	544.32	583.20	625.82	660.97	699.84
27	201.89	222.07	242.26	262.45	282.64	302.82	323.01	343.20	363.38	383.58	403.76	423.95	444.13	464.32	484.51	524.89	565.26	605.63	649.00	686.38	726.76
28	209.36	230.29	251.23	272.16	293.11	314.04	334.98	355.91	376.85	397.78	418.71	439.65	460.58	481.52	502.45	544.32	586.19	628.07	672.18	711.81	753.68
29	216.84	238.53	260.20	281.89	303.57	325.25	346.94	368.61	390.30	411.98	433.67	455.35	477.04	498.71	520.40	563.77	607.12	650.49	695.35	737.22	780.59
30*	224.31	246.75	269.17	291.61	314.04	336.47	358.90	381.33	403.76	426.19	448.62	471.06	493.48	515.92	538.34	583.20	628.07	672.93	718.54	762.65	807.51
31*	231.79	254.97	278.14	301.33	324.50	347.68	370.86	394.04	417.21	440.40	463.57	486.75	509.93	533.11	556.28	602.64	649.00	695.35	741.71	788.07	834.42
32*	239.27	263.19	287.13	311.05	334.98	358.90	382.83	406.75	430.68	454.60	478.53	502.45	526.38	550.30	574.23	622.09	669.94	717.79	765.64	813.49	861.34
33*	246.75	271.42	296.10	320.76	345.44	370.11	394.79	419.46	444.13	468.81	493.48	518.16	542.83	567.51	592.17	641.52	690.87	740.21	789.56	838.91	888.26
34*	254.22	279.64	305.07	330.49	355.91	381.33	406.75	432.17	457.59	483.02	508.43	533.86	559.27	584.70	610.13	660.97	711.81	762.65	813.49	864.33	915.17
35*	261.70	287.87	314.04	340.21	366.37	392.55	418.71	444.88	471.06	497.22	523.39	549.56	575.73	601.89	628.07	680.40	732.74	785.08	837.41	889.76	942.10
36*	269.17	296.10	323.01	349.93	376.85	403.76	430.68	457.59	484.51	511.42	538.34	565.26	592.17	619.10	646.01	699.84	753.68	807.51	861.34	915.17	969.01
37+	EMAIL FOR QUOTE																				

\*Oversize charges will apply

## PRICE AS LISTED

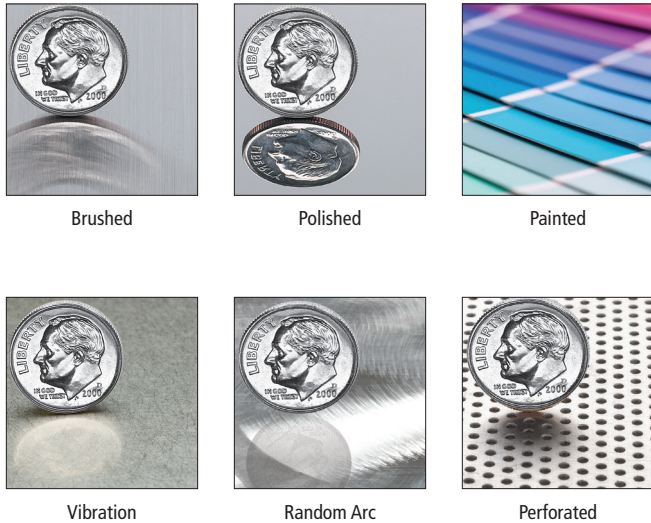

## OPTIONAL FINISHES - ADD 30%



# Your Logo 1-1/2" Deep #304 Stainless Steel with Back

**PRICE PER LOGO.** Including standard mounting with pattern.

*Logos smaller than 10" x 10" or with more than 3 pieces email for quote*

SIZE	10"	11"	12"	13"	14"	15"	16"	17"	18"	19"*	20"*	21"*	22"*	23"*	24"*	26"*	28"*	30"*	32"*	34"*	36"*
10"	\$86.80	\$95.48	\$104.15	\$112.83	\$121.51	\$130.18	\$138.87	\$147.55	\$156.22	\$164.90	\$173.57	\$182.26	\$190.94	\$199.61	\$208.29	\$225.65	\$243.01	\$260.36	\$277.72	\$295.08	\$312.44
11	95.48	105.02	114.57	124.11	133.66	143.20	152.75	162.29	171.85	181.39	190.94	200.48	210.03	219.57	229.12	248.21	267.31	286.40	305.49	324.58	343.68
12	104.15	114.57	124.98	135.39	145.81	156.22	166.64	177.05	187.47	197.89	208.29	218.71	229.12	239.54	249.95	270.78	291.61	312.44	333.26	354.09	374.92
13	112.83	124.11	135.39	146.68	157.96	169.24	180.52	191.80	203.08	214.36	225.65	236.93	248.21	259.50	270.78	293.35	315.91	338.47	361.04	383.60	406.16
14	121.51	133.66	145.81	157.96	170.11	182.26	194.41	206.56	218.71	230.86	243.01	255.16	267.31	279.45	291.61	315.91	340.21	364.51	388.81	413.11	437.41
15	130.18	143.20	156.22	169.24	182.26	195.27	208.29	221.31	234.33	247.35	260.36	273.38	286.40	299.42	312.44	338.47	364.51	390.54	416.58	442.62	468.65
16	138.87	152.75	166.64	180.52	194.41	208.29	222.18	236.07	249.95	263.84	277.72	291.61	305.49	319.38	333.26	361.04	388.81	416.58	444.35	472.11	499.89
17	147.55	162.29	177.05	191.80	206.56	221.31	236.07	250.82	265.57	280.33	295.08	309.84	324.58	339.34	354.09	383.60	413.11	442.62	472.11	501.62	531.13
18	156.22	171.85	187.47	203.08	218.71	234.33	249.95	265.57	281.19	296.82	312.44	328.05	343.68	359.30	374.92	406.16	437.41	468.65	499.89	531.13	562.38
19	164.90	181.39	197.89	214.36	230.86	247.35	263.84	280.33	296.82	313.30	329.79	346.28	362.77	379.26	395.75	428.72	461.71	494.69	527.66	560.64	593.62
20	173.57	190.94	208.29	225.65	243.01	260.36	277.72	295.08	312.44	329.79	347.14	364.51	381.86	399.22	416.58	451.29	486.01	520.71	555.43	590.15	624.86
21	182.26	200.48	218.71	236.93	255.16	273.38	291.61	309.84	328.05	346.28	364.51	382.74	400.95	419.18	437.41	473.85	510.31	546.75	583.20	619.66	656.10
22	190.94	210.03	229.12	248.21	267.31	286.40	305.49	324.58	343.68	362.77	381.86	400.95	420.05	439.14	458.23	496.41	534.61	572.79	610.98	649.16	687.35
23	199.61	219.57	239.54	259.50	279.45	299.42	319.38	339.34	359.30	379.26	399.22	419.18	439.14	459.10	479.06	518.99	558.90	598.82	638.75	678.67	718.59
24	208.29	229.12	249.95	270.78	291.61	312.44	333.26	354.09	374.92	395.75	416.58	437.41	458.23	479.06	499.89	541.55	583.20	624.86	666.52	708.17	749.83
25	216.98	238.66	260.36	282.07	303.75	325.45	347.14	368.84	390.54	412.23	433.93	455.63	477.32	499.02	520.71	564.11	607.50	650.89	694.28	737.68	781.07
26	225.65	248.21	270.78	293.35	315.91	338.47	361.04	383.60	406.16	428.72	451.29	473.85	496.41	518.99	541.55	586.68	631.80	676.93	722.06	767.19	812.32
27	234.33	257.77	281.19	304.63	328.05	351.49	374.92	398.35	421.78	445.22	468.65	492.08	515.52	538.94	562.38	609.24	656.10	702.97	749.83	796.69	843.55
28	243.01	267.31	291.61	315.91	340.21	364.51	388.81	413.11	437.41	461.71	486.01	510.31	534.61	558.90	583.20	631.80	680.40	729.00	777.60	826.20	874.80
29	251.68	276.86	302.02	327.19	352.35	377.53	402.69	427.86	453.02	478.20	503.36	528.53	553.70	578.87	604.03	654.37	704.70	755.04	805.37	855.71	906.04
30*	260.36	286.40	312.44	338.47	364.51	390.54	416.58	442.62	468.65	494.69	520.71	546.75	572.79	598.82	624.86	676.93	729.00	781.07	833.15	885.22	937.29
31*	269.05	295.95	322.84	349.75	376.65	403.56	430.46	457.37	484.27	511.17	538.08	564.98	591.89	618.79	645.68	699.49	753.30	807.11	860.92	914.73	968.52
32*	277.72	305.49	333.26	361.04	388.81	416.58	444.35	472.11	499.89	527.66	555.43	583.20	610.98	638.75	666.52	722.06	777.60	833.15	888.69	944.22	999.77
33*	286.40	315.04	343.68	372.32	400.95	429.60	458.23	486.87	515.52	544.15	572.79	601.43	630.07	658.70	687.35	744.62	801.90	859.18	916.46	973.73	1,031.01
34*	295.08	324.58	354.09	383.60	413.11	442.62	472.11	501.62	531.13	560.64	590.15	619.66	649.16	678.67	708.17	767.19	826.20	885.22	944.22	1,003.24	1,062.26
35*	303.75	334.14	364.51	394.88	425.25	455.63	486.01	516.38	546.75	577.13	607.50	637.88	668.26	698.63	729.00	789.76	850.50	911.25	972.00	1,032.75	1,093.49
36*	312.44	343.68	374.92	406.16	437.41	468.65	499.89	531.13	562.38	593.62	624.86	656.10	687.35	718.59	749.83	812.32	874.80	937.29	999.77	1,062.26	1,124.74
37+	EMAIL FOR QUOTE																				

\*Oversize charges will apply

## PRICE AS LISTED



Brushed



Polished



Painted

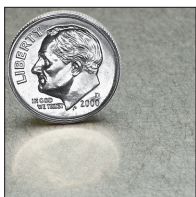

Vibration



Random Arc

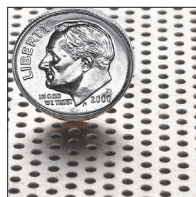

Perforated

## OPTIONAL FINISHES - ADD 30%



Brushed 316 Alloy

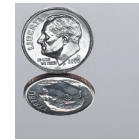

Polished 316 Alloy



Brushed Gold



Brushed Copper

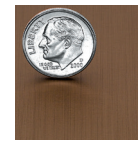

Brushed Medium Bronze



Brushed Black

Titanium Coated

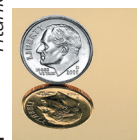

Polished Gold

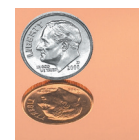

Polished Copper

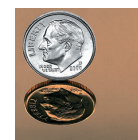

Polished Medium Bronze

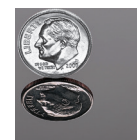

Polished Black



# Your Logo 2" Deep #304 Stainless Steel without Back

**PRICE PER LOGO.** Including standard mounting with pattern.

*Logos smaller than 10" x 10" or with more than 3 pieces email for quote*

SIZE	10"	11"	12"	13"	14"	15"	16"	17"	18"	19"*	20"*	21"*	22"*	23"*	24"*	26"*	28"*	30"*	32"*	34"*	36"*
10"	\$78.03	\$85.83	\$93.63	\$101.44	\$109.24	\$117.04	\$124.84	\$132.64	\$140.44	\$148.25	\$156.05	\$163.85	\$171.65	\$179.45	\$187.25	\$202.86	\$218.46	\$234.06	\$266.06	\$265.28	\$280.88
11	85.83	94.41	103.00	111.58	120.16	128.74	137.32	145.90	154.49	163.07	171.65	180.23	188.81	197.40	205.98	223.14	240.30	257.48	290.24	291.80	308.97
12	93.63	103.00	112.36	121.72	131.08	140.44	149.81	159.17	168.53	177.89	187.25	196.62	205.98	215.34	224.70	243.42	262.16	280.88	314.43	318.33	337.05
13	101.44	111.58	121.72	131.86	142.00	152.15	162.29	172.43	182.57	192.71	202.86	213.00	223.14	233.28	243.42	263.72	284.00	304.29	338.61	344.86	365.14
14	109.24	120.16	131.08	142.00	152.93	163.85	174.77	185.69	196.62	207.54	218.46	229.38	240.30	251.24	262.16	284.00	305.85	327.69	362.80	371.38	393.23
15	117.04	128.74	140.44	152.15	163.85	175.55	187.25	198.96	210.66	222.36	234.06	245.78	257.48	269.18	280.88	304.29	327.69	351.10	386.98	397.91	421.31
16	124.84	137.32	149.81	162.29	174.77	187.25	199.74	212.22	224.70	237.18	249.68	262.16	274.64	287.12	299.61	324.57	349.54	374.50	411.17	424.43	449.40
17	132.64	145.90	159.17	172.43	185.69	198.96	212.22	225.48	238.74	252.02	265.28	278.54	291.80	305.07	318.33	344.86	371.38	397.91	435.35	450.96	477.48
18	140.44	154.49	168.53	182.57	196.62	210.66	224.70	238.74	252.80	266.84	280.88	294.93	308.97	323.01	337.05	365.14	393.23	421.31	459.54	477.48	505.58
19	148.25	163.07	177.89	192.71	207.54	222.36	237.18	252.02	266.84	281.66	296.49	311.31	326.13	340.95	355.78	385.42	415.07	444.72	483.72	504.02	533.66
20	156.05	171.65	187.25	202.86	218.46	234.06	249.68	265.28	280.88	296.49	312.09	327.69	343.30	358.90	374.50	405.71	436.91	468.12	507.92	530.54	561.75
21	163.85	180.23	196.62	213.00	229.38	245.78	262.16	278.54	294.93	311.31	327.69	344.08	360.46	376.84	393.23	425.99	458.76	491.54	532.10	557.07	589.84
22	171.65	188.81	205.98	223.14	240.30	257.48	274.64	291.80	308.97	326.13	343.30	360.46	377.62	394.79	411.95	446.28	480.60	514.94	556.29	583.35	617.92
23	179.45	197.40	215.34	233.28	251.24	269.18	287.12	305.07	323.01	340.95	358.90	376.84	394.79	412.73	430.67	466.56	502.46	538.35	580.47	610.12	646.01
24	187.25	205.98	224.70	243.42	262.16	280.88	299.61	318.33	337.05	355.78	374.50	393.23	411.95	430.67	449.40	486.84	524.30	561.75	604.66	636.65	674.09
25	195.05	214.56	234.06	253.58	273.08	292.58	312.09	331.59	351.10	370.60	390.10	409.61	429.11	448.62	468.12	507.14	546.15	585.15	628.84	663.17	702.18
26	202.86	223.14	243.42	263.72	284.00	304.29	324.57	344.86	365.14	385.42	405.71	425.99	446.28	466.56	486.84	527.42	567.99	608.56	653.03	689.70	730.26
27	210.66	231.72	252.80	273.86	294.93	315.99	337.05	358.12	379.18	400.25	421.31	442.38	463.44	484.50	505.58	547.71	589.84	631.96	677.21	716.22	758.36
28	218.46	240.30	262.16	284.00	305.85	327.69	349.54	371.38	393.23	415.07	436.91	458.76	480.60	502.46	524.30	567.99	611.68	655.37	701.40	742.76	786.45
29	226.26	248.90	271.52	294.15	316.77	339.39	362.02	384.64	407.27	429.89	452.52	475.14	497.78	520.40	543.03	588.28	633.52	678.77	725.58	769.28	814.53
30*	234.06	257.48	280.88	304.29	327.69	351.10	374.50	397.91	421.31	444.72	468.12	491.54	514.94	538.35	561.75	608.56	655.37	702.18	749.78	795.81	842.62
31*	241.86	266.06	290.24	314.43	338.61	362.80	386.98	411.17	435.35	459.54	483.72	507.92	532.10	556.29	580.47	628.84	677.21	725.58	773.96	822.33	870.70
32*	249.68	274.64	299.61	324.57	349.54	374.50	399.47	424.43	449.40	474.36	499.34	524.30	549.27	574.23	599.20	649.13	699.06	749.00	798.93	848.86	898.79
33*	257.48	283.22	308.97	334.71	360.46	386.20	411.95	437.69	463.44	489.20	514.94	540.69	566.43	592.18	617.92	669.41	720.90	772.40	823.89	875.38	926.88
34*	265.28	291.80	318.33	344.86	371.38	397.91	424.43	450.96	477.48	504.02	530.54	557.07	583.59	610.12	636.65	689.70	742.76	795.81	848.86	901.91	954.96
35*	273.08	300.39	327.69	355.00	382.30	409.61	436.91	464.22	491.54	518.84	546.15	573.45	600.76	628.06	655.37	709.98	764.60	819.21	873.82	928.44	983.06
36*	280.88	308.97	337.05	365.14	393.23	421.31	449.40	477.48	505.58	533.66	561.75	589.84	617.92	646.01	674.09	730.26	786.45	842.62	898.79	954.96	1,011.14
37+	EMAIL FOR QUOTE																				

\*Oversize charges will apply

## PRICE AS LISTED



Brushed



Polished



Painted

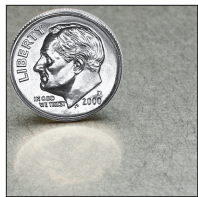

Vibration



Random Arc

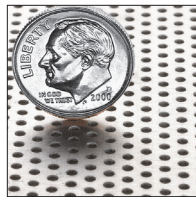

Perforated

## OPTIONAL FINISHES - ADD 30%



Brushed 316 Alloy

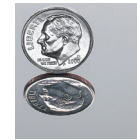

Polished 316 Alloy



Brushed Gold



Brushed Copper



Brushed Medium Bronze



Brushed Black

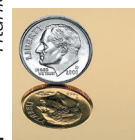

Polished Gold

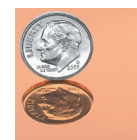

Polished Copper

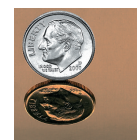

Polished Medium Bronze

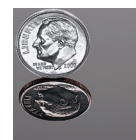

Polished Black

# Your Logo 2" Deep #304 Stainless Steel with Back

**PRICE PER LOGO.** Including standard mounting with pattern.

*Logos smaller than 10" x 10" or with more than 3 pieces email for quote*

SIZE	10"	11"	12"	13"	14"	15"	16"	17"	18"	19"*	20"*	21"*	22"*	23"*	24"*	26"*	28"*	30"*	32"*	34"*	36"*
10"	\$90.57	\$99.63	\$108.68	\$117.74	\$126.80	\$135.84	\$144.90	\$153.96	\$163.01	\$172.07	\$181.12	\$190.18	\$199.24	\$208.29	\$217.35	\$235.46	\$253.58	\$271.68	\$289.79	\$307.91	\$326.02
11	99.63	109.59	119.55	129.51	139.47	149.43	159.39	169.35	179.32	189.28	199.24	209.20	219.16	229.12	239.08	259.00	278.93	298.85	318.77	338.69	358.62
12	108.68	119.55	130.41	141.28	152.15	163.01	173.88	184.74	195.62	206.49	217.35	228.22	239.08	249.95	260.81	282.56	304.29	326.02	347.75	369.48	391.22
13	117.74	129.51	141.28	153.05	164.82	176.60	188.37	200.14	211.91	223.68	235.46	247.23	259.00	270.78	282.56	306.10	329.64	353.19	376.73	400.28	423.82
14	126.80	139.47	152.15	164.82	177.51	190.18	202.86	215.54	228.22	240.89	253.58	266.25	278.93	291.60	304.29	329.64	355.00	380.36	405.71	431.07	456.42
15	135.84	149.43	163.01	176.60	190.18	203.76	217.35	230.93	244.52	258.10	271.68	285.27	298.85	312.44	326.02	353.19	380.36	407.52	434.69	461.86	489.03
16	144.90	159.39	173.88	188.37	202.86	217.35	231.84	246.33	260.81	275.31	289.79	304.29	318.77	333.27	347.75	376.73	405.71	434.69	463.67	492.64	521.62
17	153.96	169.35	184.74	200.14	215.54	230.93	246.33	261.72	277.12	292.52	307.91	323.31	338.69	354.09	369.48	400.28	431.07	461.86	492.64	523.43	554.22
18	163.01	179.32	195.62	211.91	228.22	244.52	260.81	277.12	293.42	309.72	326.02	342.32	358.62	374.92	391.22	423.82	456.42	489.03	521.62	554.22	586.83
19	172.07	189.28	206.49	223.68	240.89	258.10	275.31	292.52	309.72	326.92	344.13	361.34	378.54	395.75	412.96	447.36	481.78	516.20	550.60	585.02	619.43
20	181.12	199.24	217.35	235.46	253.58	271.68	289.79	307.91	326.02	344.13	362.24	380.36	398.46	416.57	434.69	470.91	507.14	543.35	579.58	615.81	652.02
21	190.18	209.20	228.22	247.23	266.25	285.27	304.29	323.31	342.32	361.34	380.36	399.38	418.38	437.40	456.42	494.45	532.49	570.52	608.56	646.60	684.63
22	199.24	219.16	239.08	259.00	278.93	298.85	318.77	338.69	358.62	378.54	398.46	418.38	438.32	458.24	478.16	518.00	557.85	597.69	637.54	677.38	717.23
23	208.29	229.12	249.95	270.78	291.60	312.44	333.27	354.09	374.92	395.75	416.57	437.40	458.24	479.06	499.89	541.55	583.20	624.86	666.52	708.17	749.84
24	217.35	239.08	260.81	282.56	304.29	326.02	347.75	369.48	391.22	412.96	434.69	456.42	478.16	499.89	521.62	565.10	608.56	652.02	695.50	738.96	782.43
25	226.41	249.04	271.68	294.33	316.96	339.60	362.24	384.88	407.52	430.16	452.80	475.44	498.08	520.72	543.35	588.64	633.92	679.19	724.47	769.76	815.03
26	235.46	259.00	282.56	306.10	329.64	353.19	376.73	400.28	423.82	447.36	470.91	494.45	518.00	541.55	565.10	612.18	659.27	706.36	753.45	800.55	847.64
27	244.52	268.97	293.42	317.87	342.32	366.77	391.22	415.67	440.12	464.57	489.03	513.47	537.93	562.37	586.83	635.73	684.63	733.53	782.43	831.33	880.23
28	253.58	278.93	304.29	329.64	355.00	380.36	405.71	431.07	456.42	481.78	507.14	532.49	557.85	583.20	608.56	659.27	709.98	760.70	811.41	862.12	912.83
29	262.62	288.89	315.15	341.42	367.67	393.94	420.20	446.46	472.72	498.99	525.24	551.51	577.77	604.04	630.29	682.82	735.34	787.86	840.39	892.91	945.44
30*	271.68	298.85	326.02	353.19	380.36	407.52	434.69	461.86	489.03	516.20	543.35	570.52	597.69	624.86	652.02	706.36	760.70	815.03	869.37	923.70	978.04
31*	280.74	308.81	336.88	364.96	393.03	421.11	449.18	477.26	505.32	533.39	561.47	589.54	617.62	645.69	673.76	729.90	786.05	842.20	898.35	954.50	1,010.63
32*	289.79	318.77	347.75	376.73	405.71	434.69	463.67	492.64	521.62	550.60	579.58	608.56	637.54	666.52	695.50	753.45	811.41	869.37	927.33	985.28	1,043.24
33*	298.85	328.73	358.62	388.50	418.38	448.28	478.16	508.04	537.93	567.81	597.69	627.58	657.46	687.34	717.23	776.99	836.76	896.54	956.31	1,016.07	1,075.84
34*	307.91	338.69	369.48	400.28	431.07	461.86	492.64	523.43	554.22	585.02	615.81	646.60	677.38	708.17	738.96	800.55	862.12	923.70	985.28	1,046.86	1,108.44
35*	316.96	348.66	380.36	412.05	443.74	475.44	507.14	538.83	570.52	602.22	633.92	665.61	697.31	729.00	760.70	824.09	887.48	950.87	1,014.26	1,077.65	1,141.04
36*	326.02	358.62	391.22	423.82	456.42	489.03	521.62	554.22	586.83	619.43	652.02	684.63	717.23	749.84	782.43	847.64	912.83	978.04	1,043.24	1,108.44	1,173.64
37+	<b>EMAIL FOR QUOTE</b>																				

\*Oversize charges will apply

### PRICE AS LISTED



Brushed

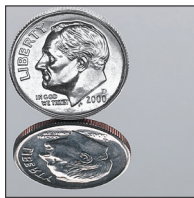

Polished



Painted

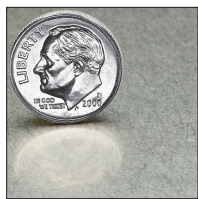

Vibration



Random Arc

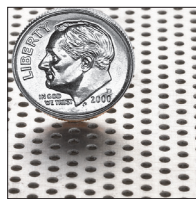

Perforated

### OPTIONAL FINISHES - ADD 30%

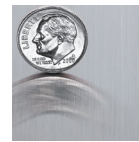

Brushed 316 Alloy

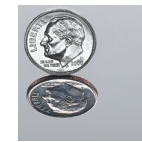

Polished 316 Alloy



Brushed Gold



Brushed Copper

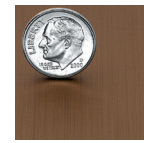

Brushed Medium Bronze



Brushed Black



Polished Gold

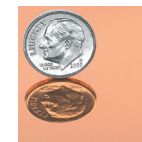

Polished Copper

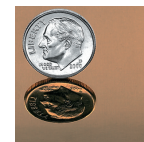

Polished Medium Bronze

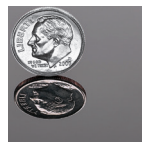

Polished Black

# Your Logo 2-1/2" Deep #304 Stainless Steel without Back

**PRICE PER LOGO.** Including standard mounting with pattern.

*Logos smaller than 10" x 10" or with more than 3 pieces email for quote*

SIZE	10"	11"	12"	13"	14"	15"	16"	17"	18"	19"*	20"*	21"*	22"*	23"*	24"*	26"*	28"*	30"*	32"*	34"*	36"*
10"	\$87.16	\$95.77	\$104.38	\$113.01	\$121.62	\$130.23	\$138.85	\$147.46	\$156.07	\$164.70	\$173.31	\$181.92	\$190.53	\$199.15	\$207.76	\$225.00	\$242.22	\$259.45	\$294.77	\$293.91	\$311.14
11	95.77	105.25	114.73	124.21	133.68	143.15	152.63	162.10	171.59	181.06	190.53	200.01	209.48	218.97	228.44	247.39	266.34	285.30	321.47	323.20	342.16
12	104.38	114.73	125.07	135.40	145.74	156.07	166.42	176.75	187.09	197.42	207.76	218.11	228.44	238.78	249.11	269.78	290.47	311.14	348.18	352.49	373.16
13	113.01	124.21	135.40	146.60	157.79	169.00	180.20	191.40	202.59	213.79	225.00	236.19	247.39	258.58	269.78	292.19	314.58	336.99	374.88	381.79	404.18
14	121.62	133.68	145.74	157.79	169.86	181.92	193.98	206.04	218.11	230.16	242.22	254.28	266.34	278.41	290.47	314.58	338.71	362.83	401.59	411.07	435.20
15	130.23	143.15	156.07	169.00	181.92	194.84	207.76	220.69	233.61	246.53	259.45	272.38	285.30	298.22	311.14	336.99	362.83	388.68	428.29	440.36	466.20
16	138.85	152.63	166.42	180.20	193.98	207.76	221.55	235.33	249.11	262.89	276.69	290.47	304.25	318.03	331.82	359.38	386.95	414.51	455.00	469.65	497.22
17	147.46	162.10	176.75	191.40	206.04	220.69	235.33	249.97	264.61	279.27	293.91	308.55	323.20	337.85	352.49	381.79	411.07	440.36	481.70	498.94	528.22
18	156.07	171.59	187.09	202.59	218.11	233.61	249.11	264.61	280.13	295.64	311.14	326.65	342.16	357.66	373.16	404.18	435.20	466.20	508.41	528.22	559.24
19	164.70	181.06	197.42	213.79	230.16	246.53	262.89	279.27	295.64	312.00	328.38	344.74	361.10	377.47	393.84	426.57	459.31	492.05	535.11	557.52	590.25
20	173.31	190.53	207.76	225.00	242.22	259.45	276.69	293.91	311.14	328.38	345.60	362.83	380.06	397.29	414.51	448.98	483.43	517.89	561.83	586.80	621.27
21	181.92	200.01	218.11	236.19	254.28	272.38	290.47	308.55	326.65	344.74	362.83	380.92	399.01	417.10	435.20	471.37	507.55	543.74	588.53	616.10	652.28
22	190.53	209.48	228.44	247.39	266.34	285.30	304.25	323.20	342.16	361.10	380.06	399.01	417.96	436.92	455.87	493.77	531.67	569.58	615.24	645.38	683.29
23	199.15	218.97	238.78	258.58	278.41	298.22	318.03	337.85	357.66	377.47	397.29	417.10	436.92	456.73	476.54	516.16	555.80	595.43	641.94	674.68	714.31
24	207.76	228.44	249.11	269.78	290.47	311.14	331.82	352.49	373.16	393.84	414.51	435.20	455.87	476.54	497.22	538.56	579.91	621.27	668.65	703.97	745.31
25	216.37	237.91	259.45	280.99	302.53	324.06	345.60	367.13	388.68	410.21	431.74	453.28	474.81	496.36	517.89	560.97	604.04	647.10	695.35	733.25	776.33
26	225.00	247.39	269.78	292.19	314.58	336.99	359.38	381.79	404.18	426.57	448.98	471.37	493.77	516.16	538.56	583.36	628.16	672.95	722.06	762.55	807.33
27	233.61	256.86	280.13	303.39	326.65	349.91	373.16	396.43	419.68	442.95	466.20	489.47	512.72	535.97	559.24	605.76	652.28	698.79	748.76	791.83	838.36
28	242.22	266.34	290.47	314.58	338.71	362.83	386.95	411.07	435.20	459.31	483.43	507.55	531.67	555.80	579.91	628.16	676.40	724.64	775.47	821.13	869.37
29	250.83	275.83	300.80	325.79	350.77	375.74	400.73	425.71	450.70	475.67	500.66	525.64	550.63	575.61	600.60	650.56	700.51	750.48	802.17	850.41	900.38
30*	259.45	285.30	311.14	336.99	362.83	388.68	414.51	440.36	466.20	492.05	517.89	543.74	569.58	595.43	621.27	672.95	724.64	776.33	828.88	879.71	931.40
31*	268.06	294.77	321.47	348.18	374.88	401.59	428.29	455.00	481.70	508.41	535.11	561.83	588.53	615.24	641.94	695.35	748.76	802.17	855.58	908.99	962.40
32*	276.69	304.25	331.82	359.38	386.95	414.51	442.09	469.65	497.22	524.78	552.35	579.91	607.49	635.05	662.62	717.75	772.88	828.02	883.15	938.29	993.42
33*	285.30	313.72	342.16	370.58	399.01	427.43	455.87	484.29	512.72	541.16	569.58	598.01	626.43	654.87	683.29	740.14	797.00	853.86	910.71	967.57	1,024.43
34*	293.91	323.20	352.49	381.79	411.07	440.36	469.65	498.94	528.22	557.52	586.80	616.10	645.38	674.68	703.97	762.55	821.13	879.71	938.29	996.86	1,055.44
35*	302.53	332.68	362.83	392.98	423.13	453.28	483.43	513.58	543.74	573.89	604.04	634.19	664.34	694.49	724.64	784.94	845.25	905.55	965.85	1,026.16	1,086.46
36*	311.14	342.16	373.16	404.18	435.20	466.20	497.22	528.22	559.24	590.25	621.27	652.28	683.29	714.31	745.31	807.33	869.37	931.40	993.42	1,055.44	1,117.47
37+	<b>EMAIL FOR QUOTE</b>																				

\*Oversize charges will apply

## PRICE AS LISTED

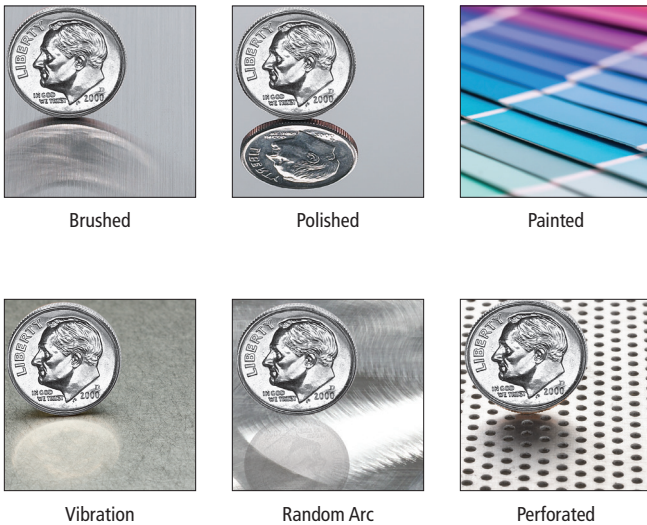

## OPTIONAL FINISHES - ADD 30%





# Your Logo 2-1/2" Deep #304 Stainless Steel with Back

**PRICE PER LOGO.** Including standard mounting with pattern.

*Logos smaller than 10" x 10" or with more than 3 pieces email for quote*

SIZE	10"	11"	12"	13"	14"	15"	16"	17"	18"	19"*	20"*	21"*	22"*	23"*	24"*	26"*	28"*	30"*	32"*	34"*	36"*
10"	\$101.01	\$111.01	\$121.00	\$131.00	\$141.01	\$150.99	\$161.00	\$171.00	\$180.99	\$191.00	\$200.99	\$210.99	\$221.00	\$230.99	\$240.99	\$260.99	\$280.99	\$300.98	\$320.98	\$340.99	\$360.98
11	111.01	122.01	133.00	144.00	155.00	166.00	176.99	187.99	199.00	210.00	221.00	231.99	242.99	253.99	264.99	286.98	308.99	330.98	352.98	374.97	396.98
12	121.00	133.00	145.00	157.00	169.00	180.99	193.00	204.99	217.00	229.00	240.99	253.00	264.99	276.99	288.98	312.99	336.99	360.98	384.98	408.97	432.97
13	131.00	144.00	157.00	170.00	182.99	196.00	208.99	221.99	234.99	247.98	260.99	273.98	286.98	299.99	312.99	338.99	364.98	390.98	416.98	442.98	468.97
14	141.01	155.00	169.00	182.99	197.00	210.99	225.00	238.99	253.00	266.99	280.99	294.99	308.99	322.98	336.99	364.98	392.98	420.98	448.98	476.97	504.97
15	150.99	166.00	180.99	196.00	210.99	225.99	240.99	255.99	270.99	285.99	300.98	315.99	330.98	345.99	360.98	390.98	420.98	450.97	480.97	510.97	540.97
16	161.00	176.99	193.00	208.99	225.00	240.99	256.99	272.99	288.98	304.99	320.98	336.99	352.98	368.99	384.98	416.98	448.98	480.97	512.97	544.96	576.96
17	171.00	187.99	204.99	221.99	238.99	255.99	272.99	289.99	306.99	323.99	340.99	357.99	374.97	391.98	408.97	442.98	476.97	510.97	544.96	578.96	612.96
18	180.99	199.00	217.00	234.99	253.00	270.99	288.98	306.99	324.98	342.99	360.98	378.98	396.98	414.98	432.97	468.97	504.97	540.97	576.96	612.96	648.96
19	191.00	210.00	229.00	247.98	266.99	285.99	304.99	323.99	342.99	361.98	380.98	399.98	418.98	437.98	456.98	494.96	532.97	570.97	608.96	646.96	684.96
20	200.99	221.00	240.99	260.99	280.99	300.98	320.98	340.99	360.98	380.98	400.97	420.98	440.97	460.97	480.97	520.96	560.97	600.95	640.96	680.96	720.94
21	210.99	231.99	253.00	273.98	294.99	315.99	336.99	357.99	378.98	399.98	420.98	441.98	462.97	483.97	504.97	546.96	588.96	630.95	672.95	714.96	756.95
22	221.00	242.99	264.99	286.98	308.99	330.98	352.98	374.97	396.98	418.98	440.97	462.97	484.98	506.97	528.97	572.96	616.96	660.95	704.95	748.94	792.95
23	230.99	253.99	276.99	299.99	322.98	345.99	368.99	391.98	414.98	437.98	460.97	483.97	506.97	529.96	552.96	598.97	644.95	690.95	736.95	782.94	828.95
24	240.99	264.99	288.98	312.99	336.99	360.98	384.98	408.97	432.97	456.98	480.97	504.97	528.97	552.96	576.96	624.96	672.95	720.94	768.95	816.94	864.93
25	251.00	275.98	300.98	325.99	350.98	375.98	400.97	425.97	450.97	475.97	500.97	525.97	550.96	575.96	600.95	650.96	700.95	750.94	800.94	850.94	900.93
26	260.99	286.98	312.99	338.99	364.98	390.98	416.98	442.98	468.97	494.96	520.96	546.96	572.96	598.97	624.96	676.95	728.95	780.94	832.94	884.94	936.94
27	270.99	297.99	324.98	351.99	378.98	405.98	432.97	459.97	486.97	513.97	540.97	567.96	594.97	621.95	648.96	702.95	756.95	810.94	864.93	918.93	972.92
28	280.99	308.99	336.99	364.98	392.98	420.98	448.98	476.97	504.97	532.97	560.97	588.96	616.96	644.95	672.95	728.95	784.94	840.94	896.93	952.93	1,008.92
29	290.98	319.99	348.98	377.98	406.97	435.98	464.97	493.97	522.96	551.97	580.96	609.96	638.96	667.96	696.95	754.95	812.94	870.93	928.93	986.93	1,044.92
30*	300.98	330.98	360.98	390.98	420.98	450.97	480.97	510.97	540.97	570.97	600.95	630.95	660.95	690.95	720.94	780.94	840.94	900.93	960.93	1,020.92	1,080.92
31*	310.99	341.98	372.97	403.98	434.97	465.98	496.97	527.97	558.96	589.96	620.96	651.95	682.96	713.95	744.94	806.94	868.93	930.93	992.93	1,054.93	1,116.91
32*	320.98	352.98	384.98	416.98	448.98	480.97	512.97	544.96	576.96	608.96	640.96	672.95	704.95	736.95	768.95	832.94	896.93	960.93	1,024.93	1,088.91	1,152.91
33*	330.98	363.98	396.98	429.97	462.97	495.98	528.97	561.96	594.97	627.96	660.95	693.96	726.95	759.94	792.95	858.93	924.93	990.93	1,056.93	1,122.91	1,188.91
34*	340.99	374.97	408.97	442.98	476.97	510.97	544.96	578.96	612.96	646.96	680.96	714.96	748.94	782.94	816.94	884.94	952.93	1,020.92	1,088.91	1,156.91	1,224.91
35*	350.98	385.98	420.98	455.97	490.97	525.97	560.97	595.96	630.95	665.96	700.95	735.95	770.95	805.94	840.94	910.94	980.93	1,050.92	1,120.91	1,190.91	1,260.90
36*	360.98	396.98	432.97	468.97	504.97	540.97	576.96	612.96	648.96	684.96	720.94	756.95	792.95	828.95	864.93	936.94	1,008.92	1,080.92	1,152.91	1,224.91	1,296.90
37+	EMAIL FOR QUOTE																				

\*Oversize charges will apply

## PRICE AS LISTED



Brushed



Polished



Painted

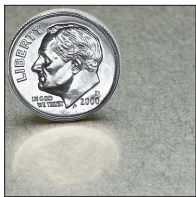

Vibration



Random Arc

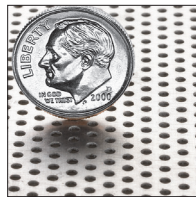

Perforated

## OPTIONAL FINISHES - ADD 30%



Brushed 316 Alloy

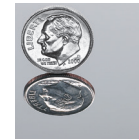

Polished 316 Alloy



Brushed Gold

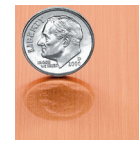

Brushed Copper

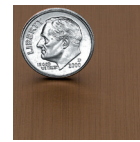

Brushed Medium Bronze



Brushed Black



Polished Gold

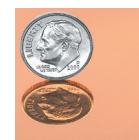

Polished Copper



Polished Medium Bronze

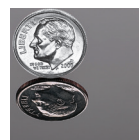

Polished Black

# Your Logo 3" Deep #304 Stainless Steel without Back

**PRICE PER LOGO.** Including standard mounting with pattern.

*Logos smaller than 10" x 10" or with more than 3 pieces email for quote*

SIZE	10"	11"	12"	13"	14"	15"	16"	17"	18"	19"*	20"*	21"*	22"*	23"*	24"*	26"*	28"*	30"*	32"*	34"*	36"*
10"	\$94.28	\$103.71	\$113.13	\$122.57	\$132.00	\$141.42	\$150.85	\$160.27	\$169.70	\$179.14	\$188.56	\$197.99	\$207.41	\$216.84	\$226.26	\$245.13	\$263.98	\$282.83	\$321.48	\$320.54	\$339.39
11	103.71	114.08	124.46	134.83	145.19	155.56	165.93	176.30	186.68	197.05	207.41	217.78	228.15	238.53	248.90	269.63	290.37	311.12	350.70	352.59	373.34
12	113.13	124.46	135.77	147.08	158.39	169.70	181.02	192.33	203.64	214.95	226.26	237.59	248.90	260.21	271.52	294.14	316.77	339.39	379.93	384.65	407.27
13	122.57	134.83	147.08	159.33	171.58	183.85	196.10	208.36	220.61	232.86	245.13	257.38	269.63	281.88	294.14	318.66	343.16	367.68	409.15	416.71	441.21
14	132.00	145.19	158.39	171.58	184.79	197.99	211.18	224.38	237.59	250.78	263.98	277.17	290.37	303.58	316.77	343.16	369.57	395.96	438.38	448.75	475.16
15	141.42	155.56	169.70	183.85	197.99	212.13	226.26	240.41	254.55	268.69	282.83	296.98	311.12	325.25	339.39	367.68	395.96	424.25	467.60	480.81	509.09
16	150.85	165.93	181.02	196.10	211.18	226.26	241.36	256.44	271.52	286.60	301.69	316.77	331.85	346.93	362.03	392.19	422.36	452.52	496.83	512.86	543.03
17	160.27	176.30	192.33	208.36	224.38	240.41	256.44	272.46	288.48	304.52	320.54	336.56	352.59	368.62	384.65	416.71	448.75	480.81	526.05	544.91	576.96
18	169.70	186.68	203.64	220.61	237.59	254.55	271.52	288.48	305.46	322.43	339.39	356.37	373.34	390.30	407.27	441.21	475.16	509.09	555.28	576.96	610.90
19	179.14	197.05	214.95	232.86	250.78	268.69	286.60	304.52	322.43	340.33	358.26	376.16	394.07	411.98	429.90	465.72	501.55	537.37	584.50	609.02	644.83
20	188.56	207.41	226.26	245.13	263.98	282.83	301.69	320.54	339.39	358.26	377.11	395.96	414.82	433.67	452.52	490.24	527.94	565.65	613.73	641.06	678.78
21	197.99	217.78	237.59	257.38	277.17	296.98	316.77	336.56	356.37	376.16	395.96	415.76	435.56	455.35	475.16	514.74	554.34	593.94	642.95	673.12	712.72
22	207.41	228.15	248.90	269.63	290.37	311.12	331.85	352.59	373.34	394.07	414.82	435.56	456.29	477.04	497.78	539.26	580.73	622.21	672.18	705.17	746.65
23	216.84	238.53	260.21	281.88	303.58	325.25	346.93	368.62	390.30	411.98	433.67	455.35	477.04	498.72	520.40	563.76	607.13	650.50	701.40	737.23	780.60
24	226.26	248.90	271.52	294.14	316.77	339.39	362.03	384.65	407.27	429.90	452.52	475.16	497.78	520.40	543.03	588.27	633.52	678.78	730.63	769.29	814.53
25	235.69	259.26	282.83	306.40	329.97	353.53	377.11	400.67	424.25	447.81	471.37	494.95	518.51	542.09	565.65	612.79	659.93	707.05	759.85	801.33	848.47
26	245.13	269.63	294.14	318.66	343.16	367.68	392.19	416.71	441.21	465.72	490.24	514.74	539.26	563.76	588.27	637.29	686.32	735.34	789.08	833.39	882.40
27	254.55	280.00	305.46	330.91	356.37	381.82	407.27	432.73	458.18	483.64	509.09	534.55	559.99	585.44	610.90	661.81	712.72	763.62	818.30	865.44	916.35
28	263.98	290.37	316.77	343.16	369.57	395.96	422.36	448.75	475.16	501.55	527.94	554.34	580.73	607.13	633.52	686.32	739.11	791.91	847.53	897.50	950.29
29	273.40	300.75	328.08	355.43	382.76	410.09	437.44	464.77	492.12	519.45	546.80	574.13	601.48	628.81	656.16	710.84	765.50	820.18	876.75	929.54	984.22
30*	282.83	311.12	339.39	367.68	395.96	424.25	452.52	480.81	509.09	537.37	565.65	593.94	622.21	650.50	678.78	735.34	791.91	848.47	905.98	961.60	1,018.17
31*	292.25	321.48	350.70	379.93	409.15	438.38	467.60	496.83	526.05	555.28	584.50	613.73	642.95	672.18	701.40	759.85	818.30	876.75	935.20	993.65	1,052.10
32*	301.69	331.85	362.03	392.19	422.36	452.52	482.70	512.86	543.03	573.19	603.36	633.52	663.70	693.86	724.03	784.37	844.70	905.04	965.37	1,025.71	1,086.04
33*	311.12	342.22	373.34	404.44	435.56	466.66	497.78	528.88	559.99	591.11	622.21	653.33	684.43	715.55	746.65	808.87	871.09	933.31	995.53	1,057.75	1,119.98
34*	320.54	352.59	384.65	416.71	448.75	480.81	512.86	544.91	576.96	609.02	641.06	673.12	705.17	737.23	769.29	833.39	897.50	961.60	1,025.71	1,089.81	1,153.91
35*	329.97	362.97	395.96	428.96	461.95	494.95	527.94	560.94	593.94	626.93	659.93	692.92	725.92	758.91	791.91	857.90	923.89	989.88	1,055.87	1,121.87	1,187.86
36*	339.39	373.34	407.27	441.21	475.16	509.09	543.03	576.96	610.90	644.83	678.78	712.72	746.65	780.60	814.53	882.40	950.29	1,018.17	1,086.04	1,153.91	1,221.79
37+	<b>EMAIL FOR QUOTE</b>																				

\*Oversize charges will apply

## PRICE AS LISTED

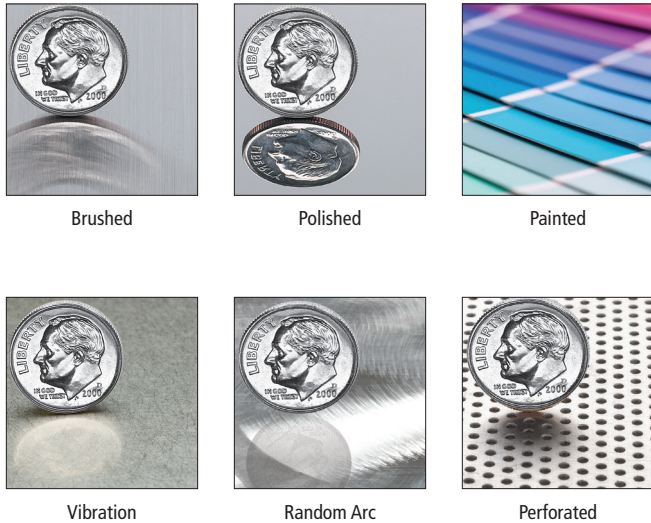

## OPTIONAL FINISHES - ADD 30%



# Your Logo 3" Deep #304 Stainless Steel with Back

**PRICE PER LOGO.** Including standard mounting with pattern.

*Logos smaller than 10" x 10" or with more than 3 pieces email for quote*

SIZE	10"	11"	12"	13"	14"	15"	16"	17"	18"	19"*	20"*	21"*	22"*	23"*	24"*	26"*	28"*	30"*	32"*	34"*	36"*
10"	\$109.44	\$120.38	\$131.32	\$142.26	\$153.21	\$164.14	\$175.09	\$186.04	\$196.97	\$207.92	\$218.85	\$229.80	\$240.75	\$251.68	\$262.63	\$284.51	\$306.40	\$328.28	\$350.17	\$372.06	\$393.94
11	120.38	132.42	144.45	156.49	168.52	180.56	192.59	204.63	216.68	228.71	240.75	252.78	264.82	276.85	288.89	312.96	337.04	361.11	385.18	409.25	433.34
12	131.32	144.45	157.58	170.71	183.85	196.97	210.11	223.23	236.37	249.51	262.63	275.77	288.89	302.03	315.15	341.42	367.68	393.94	420.20	446.46	472.72
13	142.26	156.49	170.71	184.94	199.16	213.39	227.61	241.84	256.06	270.28	284.51	298.73	312.96	327.20	341.42	369.87	398.32	426.77	455.22	483.67	512.12
14	153.21	168.52	183.85	199.16	214.49	229.80	245.13	260.44	275.77	291.08	306.40	321.72	337.04	352.35	367.68	398.32	428.96	459.60	490.24	520.87	551.51
15	164.14	180.56	196.97	213.39	229.80	246.21	262.63	279.04	295.46	311.87	328.28	344.70	361.11	377.53	393.94	426.77	459.60	492.42	525.25	558.08	590.91
16	175.09	192.59	210.11	227.61	245.13	262.63	280.14	297.65	315.15	332.66	350.17	367.68	385.18	402.70	420.20	455.22	490.24	525.25	560.27	595.27	630.29
17	186.04	204.63	223.23	241.84	260.44	279.04	297.65	316.25	334.85	353.46	372.06	390.66	409.25	427.86	446.46	483.67	520.87	558.08	595.27	632.48	669.69
18	196.97	216.68	236.37	256.06	275.77	295.46	315.15	334.85	354.54	374.25	393.94	413.63	433.34	453.03	472.72	512.12	551.51	590.91	630.29	669.69	709.08
19	207.92	228.71	249.51	270.28	291.08	311.87	332.66	353.46	374.25	395.03	415.82	436.61	457.41	478.20	498.99	540.56	582.15	623.74	665.31	706.89	748.48
20	218.85	240.75	262.63	284.51	306.40	328.28	350.17	372.06	393.94	415.82	437.70	459.60	481.48	503.36	525.25	569.01	612.79	656.55	700.33	744.10	787.86
21	229.80	252.78	275.77	298.73	321.72	344.70	367.68	390.66	413.63	436.61	459.60	482.58	505.55	528.53	551.51	597.46	643.43	689.38	735.34	781.31	827.26
22	240.75	264.82	288.89	312.96	337.04	361.11	385.18	409.25	433.34	457.41	481.48	505.55	529.63	553.70	577.77	625.91	674.07	722.21	770.36	818.50	866.66
23	251.68	276.85	302.03	327.20	352.35	377.53	402.70	427.86	453.03	478.20	503.36	528.53	553.70	578.86	604.03	654.38	704.70	755.03	805.38	855.71	906.05
24	262.63	288.89	315.15	341.42	367.68	393.94	420.20	446.46	472.72	498.99	525.25	551.51	577.77	604.03	630.29	682.82	735.34	787.86	840.40	892.91	945.43
25	273.58	300.92	328.28	355.65	382.99	410.35	437.70	465.06	492.42	519.77	547.13	574.49	601.84	629.20	656.55	711.27	765.98	820.69	875.40	930.12	984.83
26	284.51	312.96	341.42	369.87	398.32	426.77	455.22	483.67	512.12	540.56	569.01	597.46	625.91	654.38	682.82	739.72	796.62	853.52	910.42	967.33	1,024.23
27	295.46	325.01	354.54	384.10	413.63	443.18	472.72	502.27	531.81	561.36	590.91	620.45	650.00	679.53	709.08	768.17	827.26	886.35	945.43	1,004.52	1,063.61
28	306.40	337.04	367.68	398.32	428.96	459.60	490.24	520.87	551.51	582.15	612.79	643.43	674.07	704.70	735.34	796.62	857.90	919.17	980.45	1,041.73	1,103.01
29	317.34	349.08	380.80	412.54	444.27	476.01	507.74	539.48	571.20	602.94	634.67	666.41	698.14	729.88	761.60	825.07	888.54	952.00	1,015.47	1,078.94	1,142.40
30*	328.28	361.11	393.94	426.77	459.60	492.42	525.25	558.08	590.91	623.74	656.55	689.38	722.21	755.03	787.86	853.52	919.17	984.83	1,050.49	1,116.14	1,181.80
31*	339.23	373.15	407.06	440.99	474.91	508.84	542.75	576.68	610.60	644.52	678.45	712.36	746.29	780.21	814.12	881.97	949.81	1,017.66	1,085.50	1,153.35	1,221.18
32*	350.17	385.18	420.20	455.22	490.24	525.25	560.27	595.27	630.29	665.31	700.33	735.34	770.36	805.38	840.40	910.42	980.45	1,050.49	1,120.52	1,190.54	1,260.58
33*	361.11	397.22	433.34	469.44	505.55	541.67	577.77	613.88	650.00	686.10	722.21	758.33	794.43	830.54	866.66	938.87	1,011.09	1,083.31	1,155.54	1,227.75	1,299.97
34*	372.06	409.25	446.46	483.67	520.87	558.08	595.27	632.48	669.69	706.89	744.10	781.31	818.50	855.71	892.91	967.33	1,041.73	1,116.14	1,190.54	1,264.96	1,339.37
35*	382.99	421.30	459.60	497.89	536.19	574.49	612.79	651.08	689.38	727.69	765.98	804.28	842.59	880.88	919.17	995.78	1,072.37	1,148.97	1,225.56	1,302.16	1,378.75
36*	393.94	433.34	472.72	512.12	551.51	590.91	630.29	669.69	709.08	748.48	787.86	827.26	866.66	906.05	945.43	1,024.23	1,103.01	1,181.80	1,260.58	1,339.37	1,418.15
37+	EMAIL FOR QUOTE																				

\*Oversize charges will apply

## PRICE AS LISTED



Brushed



Polished



Painted

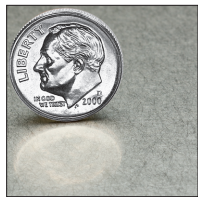

Vibration



Random Arc



Perforated

## OPTIONAL FINISHES - ADD 30%



Brushed  
316 Alloy

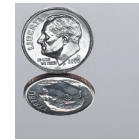

Polished  
316 Alloy



Brushed Gold



Brushed Copper

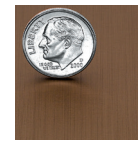

Brushed  
Medium Bronze



Brushed Black

Titanium Coated

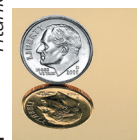

Polished Gold

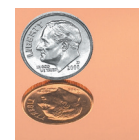

Polished Copper

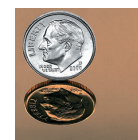

Polished  
Medium Bronze

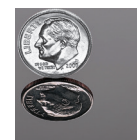

Polished Black



# Your Logo 4" Deep #304 Stainless Steel without Back

**PRICE PER LOGO.** Including standard mounting with pattern.

*Logos smaller than 10" x 10" or with more than 3 pieces email for quote*

SIZE	10"	11"	12"	13"	14"	15"	16"	17"	18"	19"*	20"*	21"*	22"*	23"*	24"*	26"*	28"*	30"*	32"*	34"*	36"*
10"	\$110.54	\$121.59	\$132.64	\$143.71	\$154.76	\$165.81	\$176.86	\$187.91	\$198.96	\$210.02	\$221.07	\$232.12	\$243.17	\$254.22	\$265.27	\$287.39	\$309.49	\$331.59	\$376.91	\$375.81	\$397.91
11	121.59	133.74	145.92	158.07	170.23	182.38	194.54	206.69	218.86	231.02	243.17	255.33	267.48	279.65	291.81	316.12	340.43	364.76	411.17	413.38	437.70
12	132.64	145.92	159.18	172.44	185.70	198.96	212.23	225.49	238.75	252.01	265.27	278.55	291.81	305.07	318.33	344.85	371.39	397.91	445.44	450.96	477.48
13	143.71	158.07	172.44	186.80	201.17	215.55	229.91	244.28	258.64	273.01	287.39	301.75	316.12	330.48	344.85	373.60	402.33	431.07	479.69	488.55	517.28
14	154.76	170.23	185.70	201.17	216.65	232.12	247.59	263.06	278.55	294.02	309.49	324.96	340.43	355.92	371.39	402.33	433.28	464.22	513.97	526.12	557.08
15	165.81	182.38	198.96	215.55	232.12	248.70	265.27	281.86	298.44	315.01	331.59	348.18	364.76	381.33	397.91	431.07	464.22	497.39	548.22	563.71	596.86
16	176.86	194.54	212.23	229.91	247.59	265.27	282.97	300.65	318.33	336.01	353.71	371.39	389.07	406.75	424.44	459.80	495.18	530.54	582.49	601.28	636.65
17	187.91	206.69	225.49	244.28	263.06	281.86	300.65	319.43	338.22	357.02	375.81	394.59	413.38	432.18	450.96	488.55	526.12	563.71	616.75	638.86	676.43
18	198.96	218.86	238.75	258.64	278.55	298.44	318.33	338.22	358.13	378.02	397.91	417.81	437.70	457.59	477.48	517.28	557.08	596.86	651.02	676.43	716.23
19	210.02	231.02	252.01	273.01	294.02	315.01	336.01	357.02	378.02	399.01	420.02	441.02	462.01	483.01	504.02	546.01	588.02	630.02	685.27	714.02	756.01
20	221.07	243.17	265.27	287.39	309.49	331.59	353.71	375.81	397.91	420.02	442.12	464.22	486.34	508.44	530.54	574.76	618.96	663.17	719.55	751.59	795.81
21	232.12	255.33	278.55	301.75	324.96	348.18	371.39	394.59	417.81	441.02	464.22	487.45	510.65	533.86	557.08	603.49	649.91	696.34	753.80	789.18	835.61
22	243.17	267.48	291.81	316.12	340.43	364.76	389.07	413.38	437.70	462.01	486.34	510.65	534.96	559.29	583.60	632.23	680.85	729.49	788.07	826.75	875.39
23	254.22	279.65	305.07	330.48	355.92	381.33	406.75	432.18	457.59	483.01	508.44	533.86	559.29	584.70	610.12	660.96	711.81	762.66	822.33	864.34	915.18
24	265.27	291.81	318.33	344.85	371.39	397.91	424.44	450.96	477.48	504.02	530.54	557.08	583.60	610.12	636.65	689.69	742.75	795.81	856.60	901.92	954.96
25	276.32	303.96	331.59	359.23	386.86	414.48	442.12	469.75	497.39	525.02	552.64	580.28	607.91	635.55	663.17	718.44	773.71	828.96	890.86	939.49	994.76
26	287.39	316.12	344.85	373.60	402.33	431.07	459.80	488.55	517.28	546.01	574.76	603.49	632.23	660.96	689.69	747.17	804.65	862.13	925.13	977.08	1,034.54
27	298.44	328.27	358.13	387.96	417.81	447.65	477.48	507.34	537.17	567.02	596.86	626.71	656.54	686.38	716.23	775.92	835.61	895.28	959.38	1,014.65	1,074.34
28	309.49	340.43	371.39	402.33	433.28	464.22	495.18	526.12	557.08	588.02	618.96	649.91	680.85	711.81	742.75	804.65	866.55	928.44	993.65	1,052.24	1,114.13
29	320.54	352.60	384.65	416.71	448.75	480.80	512.86	544.91	576.97	609.01	641.07	673.12	705.18	737.23	769.29	833.40	897.49	961.59	1,027.91	1,089.81	1,153.91
30*	331.59	364.76	397.91	431.07	464.22	497.39	530.54	563.71	596.86	630.02	663.17	696.34	729.49	762.66	795.81	862.13	928.44	994.76	1,062.18	1,127.39	1,193.71
31*	342.64	376.91	411.17	445.44	479.69	513.97	548.22	582.49	616.75	651.02	685.27	719.55	753.80	788.07	822.33	890.86	959.38	1,027.91	1,096.44	1,164.96	1,233.49
32*	353.71	389.07	424.44	459.80	495.18	530.54	565.92	601.28	636.65	672.01	707.39	742.75	778.13	813.49	848.87	919.60	990.34	1,061.08	1,131.81	1,202.55	1,273.29
33*	364.76	401.22	437.70	474.17	510.65	547.12	583.60	620.06	656.54	693.03	729.49	765.97	802.44	838.92	875.39	948.33	1,021.28	1,094.23	1,167.17	1,240.12	1,313.08
34*	375.81	413.38	450.96	488.55	526.12	563.71	601.28	638.86	676.43	714.02	751.59	789.18	826.75	864.34	901.92	977.08	1,052.24	1,127.39	1,202.55	1,277.71	1,352.86
35*	386.86	425.55	464.22	502.92	541.59	580.28	618.96	657.65	696.34	735.02	773.71	812.38	851.08	889.75	928.44	1,005.81	1,083.18	1,160.54	1,237.91	1,315.29	1,392.66
36*	397.91	437.70	477.48	517.28	557.08	596.86	636.65	676.43	716.23	756.01	795.81	835.61	875.39	915.18	954.96	1,034.54	1,114.13	1,193.71	1,273.29	1,352.86	1,432.44
37+	EMAIL FOR QUOTE																				

\*Oversize charges will apply

## PRICE AS LISTED



Brushed

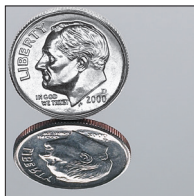

Polished

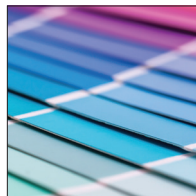

Painted

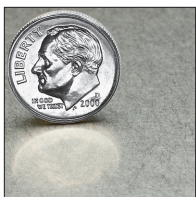

Vibration



Random Arc

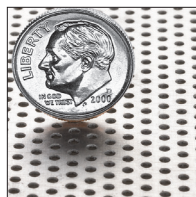

Perforated

## OPTIONAL FINISHES - ADD 30%



Brushed 316 Alloy

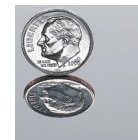

Polished 316 Alloy



Brushed Gold

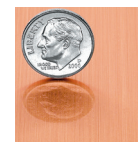

Brushed Copper

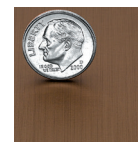

Brushed Medium Bronze



Brushed Black



Polished Gold

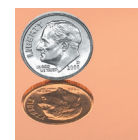

Polished Copper

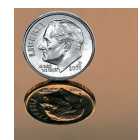

Polished Medium Bronze

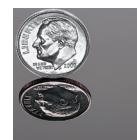

Polished Black

# Your Logo 4" Deep #304 Stainless Steel with Back

**PRICE PER LOGO.** Including standard mounting with pattern.

*Logos smaller than 10" x 10" or with more than 3 pieces email for quote*

SIZE	10"	11"	12"	13"	14"	15"	16"	17"	18"	19"*	20"*	21"*	22"*	23"*	24"*	26"*	28"*	30"*	32"*	34"*	36"*
10"	\$128.30	\$141.14	\$153.96	\$166.79	\$179.63	\$192.44	\$205.28	\$218.11	\$230.93	\$243.77	\$256.59	\$269.42	\$282.26	\$295.07	\$307.91	\$333.56	\$359.23	\$384.88	\$410.54	\$436.21	\$461.86
11	141.14	155.25	169.36	183.47	197.58	211.69	225.80	239.91	254.04	268.15	282.26	296.37	310.48	324.59	338.70	366.92	395.15	423.37	451.59	479.81	508.05
12	153.96	169.36	184.74	200.15	215.55	230.93	246.33	261.72	277.12	292.52	307.91	323.31	338.70	354.10	369.48	400.29	431.07	461.86	492.65	523.43	554.22
13	166.79	183.47	200.15	216.82	233.50	250.18	266.85	283.53	300.21	316.88	333.56	350.24	366.92	383.61	400.29	433.64	466.99	500.35	533.70	567.06	600.41
14	179.63	197.58	215.55	233.50	251.47	269.42	287.39	305.34	323.31	341.26	359.23	377.18	395.15	413.10	431.07	466.99	502.92	538.84	574.76	610.68	646.60
15	192.44	211.69	230.93	250.18	269.42	288.66	307.91	327.15	346.40	365.64	384.88	404.13	423.37	442.62	461.86	500.35	538.84	577.32	615.81	654.30	692.79
16	205.28	225.80	246.33	266.85	287.39	307.91	328.44	348.96	369.48	390.02	410.54	431.07	451.59	472.13	492.65	533.70	574.76	615.81	656.87	697.91	738.96
17	218.11	239.91	261.72	283.53	305.34	327.15	348.96	370.77	392.59	414.40	436.21	458.02	479.81	501.62	523.43	567.06	610.68	654.30	697.91	741.53	785.15
18	230.93	254.04	277.12	300.21	323.31	346.40	369.48	392.59	415.67	438.77	461.86	484.95	508.05	531.14	554.22	600.41	646.60	692.79	738.96	785.15	831.34
19	243.77	268.15	292.52	316.88	341.26	365.64	390.02	414.40	438.77	463.14	487.51	511.89	536.27	560.65	585.03	633.76	682.52	731.28	780.02	828.77	877.53
20	256.59	282.26	307.91	333.56	359.23	384.88	410.54	436.21	461.86	487.51	513.17	538.84	564.49	590.14	615.81	667.12	718.44	769.75	821.07	872.39	923.70
21	269.42	296.37	323.31	350.24	377.18	404.13	431.07	458.02	484.95	511.89	538.84	565.78	592.71	619.65	646.60	700.47	754.36	808.24	862.13	916.02	969.89
22	282.26	310.48	338.70	366.92	395.15	423.37	451.59	479.81	508.05	536.27	564.49	592.71	620.95	649.17	677.39	733.83	790.28	846.72	903.18	959.62	1,016.08
23	295.07	324.59	354.10	383.61	413.10	442.62	472.13	501.62	531.14	560.65	590.14	619.65	649.17	678.66	708.17	767.20	826.20	885.21	944.24	1,003.24	1,062.27
24	307.91	338.70	369.48	400.29	431.07	461.86	492.65	523.43	554.22	585.03	615.81	646.60	677.39	708.17	738.96	800.55	862.13	923.70	985.29	1,046.86	1,108.44
25	320.74	352.81	384.88	416.96	449.03	481.10	513.17	545.25	577.32	609.39	641.47	673.54	705.61	737.69	769.75	833.91	898.05	962.19	1,026.33	1,090.49	1,154.63
26	333.56	366.92	400.29	433.64	466.99	500.35	533.70	567.06	600.41	633.76	667.12	700.47	733.83	767.20	800.55	867.26	933.97	1,000.68	1,067.38	1,134.11	1,200.82
27	346.40	381.04	415.67	450.32	484.95	519.59	554.22	588.87	623.50	658.14	692.79	727.42	762.06	796.69	831.34	900.61	969.89	1,039.16	1,108.44	1,177.71	1,246.99
28	359.23	395.15	431.07	466.99	502.92	538.84	574.76	610.68	646.60	682.52	718.44	754.36	790.28	826.20	862.13	933.97	1,005.81	1,077.65	1,149.49	1,221.34	1,293.18
29	372.05	409.26	446.46	483.67	520.87	558.08	595.28	632.49	669.69	706.90	744.09	781.31	818.50	855.72	892.91	967.32	1,041.73	1,116.14	1,190.55	1,264.96	1,339.37
30*	384.88	423.37	461.86	500.35	538.84	577.32	615.81	654.30	692.79	731.28	769.75	808.24	846.72	885.21	923.70	1,000.68	1,077.65	1,154.63	1,231.60	1,308.58	1,385.56
31*	397.72	437.48	477.25	517.03	556.79	596.57	636.33	676.11	715.87	755.64	795.42	835.18	874.96	914.72	954.49	1,034.03	1,113.57	1,193.12	1,272.66	1,352.20	1,431.73
32*	410.54	451.59	492.65	533.70	574.76	615.81	656.87	697.91	738.96	780.02	821.07	862.13	903.18	944.24	985.29	1,067.38	1,149.49	1,231.60	1,313.71	1,395.81	1,477.92
33*	423.37	465.70	508.05	550.38	592.71	635.06	677.39	719.72	762.06	804.39	846.72	889.07	931.40	973.73	1,016.08	1,100.74	1,185.41	1,270.09	1,354.77	1,439.43	1,524.11
34*	436.21	479.81	523.43	567.06	610.68	654.30	697.91	741.53	785.15	828.77	872.39	916.02	959.62	1,003.24	1,046.86	1,134.11	1,221.34	1,308.58	1,395.81	1,483.05	1,570.29
35*	449.03	493.94	538.84	583.73	628.63	673.54	718.44	763.34	808.24	853.15	898.05	942.94	987.86	1,032.75	1,077.65	1,167.46	1,257.26	1,347.07	1,436.86	1,526.67	1,616.47
36*	461.86	508.05	554.22	600.41	646.60	692.79	738.96	785.15	831.34	877.53	923.70	969.89	1,016.08	1,062.27	1,108.44	1,200.82	1,293.18	1,385.56	1,477.92	1,570.29	1,662.66
37+	EMAIL FOR QUOTE																				

\*Oversize charges will apply

## PRICE AS LISTED



Brushed

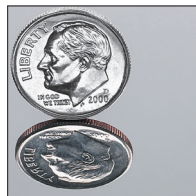

Polished

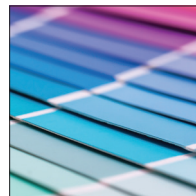

Painted

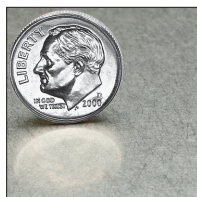

Vibration



Random Arc

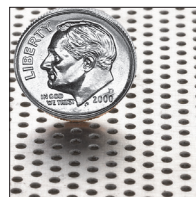

Perforated

## OPTIONAL FINISHES - ADD 30%



Brushed 316 Alloy

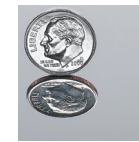

Polished 316 Alloy



Brushed Gold

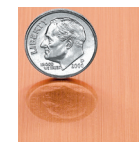

Brushed Copper

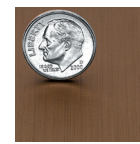

Brushed Medium Bronze

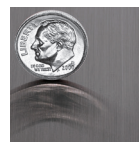

Brushed Black

Titanium Coated



Polished Gold

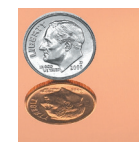

Polished Copper

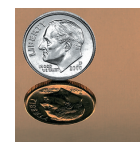

Polished Medium Bronze

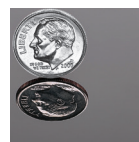

Polished Black

# Your Logo 5" Deep #304 Stainless Steel without Back

**PRICE PER LOGO.** Including standard mounting with pattern.

*Logos smaller than 10" x 10" or with more than 3 pieces email for quote*

SIZE	10"	11"	12"	13"	14"	15"	16"	17"	18"	19"*	20"*	21"*	22"*	23"*	24"*	26"*	28"*	30"*	32"*	34"*	36"*
10"	\$130.04	\$143.04	\$156.04	\$169.06	\$182.06	\$195.06	\$208.06	\$221.06	\$234.06	\$247.08	\$260.08	\$273.08	\$286.08	\$299.08	\$312.08	\$338.10	\$364.10	\$390.10	\$443.42	\$442.12	\$468.12
11	143.04	157.34	171.66	185.96	200.26	214.56	228.86	243.16	257.48	271.78	286.08	300.38	314.68	329.00	343.30	371.90	400.50	429.12	483.72	486.32	514.94
12	156.04	171.66	187.26	202.86	218.46	234.06	249.68	265.28	280.88	296.48	312.08	327.70	343.30	358.90	374.50	405.70	436.92	468.12	524.04	530.54	561.74
13	169.06	185.96	202.86	219.76	236.66	253.58	270.48	287.38	304.28	321.18	338.10	355.00	371.90	388.80	405.70	439.52	473.32	507.14	564.34	574.76	608.56
14	182.06	200.26	218.46	236.66	254.88	273.08	291.28	309.48	327.70	345.90	364.10	382.30	400.50	418.72	436.92	473.32	509.74	546.14	604.66	618.96	655.38
15	195.06	214.56	234.06	253.58	273.08	292.58	312.08	331.60	351.10	370.60	390.10	409.62	429.12	448.62	468.12	507.14	546.14	585.16	644.96	663.18	702.18
16	208.06	228.86	249.68	270.48	291.28	312.08	332.90	353.70	374.50	395.30	416.12	436.92	457.72	478.52	499.34	540.94	582.56	624.16	685.28	707.38	749.00
17	221.06	243.16	265.28	287.38	309.48	331.60	353.70	375.80	397.90	420.02	442.12	464.22	486.32	508.44	530.54	574.76	618.96	663.18	725.58	751.60	795.80
18	234.06	257.48	280.88	304.28	327.70	351.10	374.50	397.90	421.32	444.72	468.12	491.54	514.94	538.34	561.74	608.56	655.38	702.18	765.90	795.80	842.62
19	247.08	271.78	296.48	321.18	345.90	370.60	395.30	420.02	444.72	469.42	494.14	518.84	543.54	568.24	592.96	642.36	691.78	741.20	806.20	840.02	889.42
20	260.08	286.08	312.08	338.10	364.10	390.10	416.12	442.12	468.12	494.14	520.14	546.14	572.16	598.16	624.16	676.18	728.18	780.20	846.52	884.22	936.24
21	273.08	300.38	327.70	355.00	382.30	409.62	436.92	464.22	491.54	518.84	546.14	573.46	600.76	628.06	655.38	709.98	764.60	819.22	886.82	928.44	983.06
22	286.08	314.68	343.30	371.90	400.50	429.12	457.72	486.32	514.94	543.54	572.16	600.76	629.36	657.98	686.58	743.80	801.00	858.22	927.14	972.64	1,029.86
23	299.08	329.00	358.90	388.80	418.72	448.62	478.52	508.44	538.34	568.24	598.16	628.06	657.98	687.88	717.78	777.60	837.42	897.24	967.44	1,016.86	1,076.68
24	312.08	343.30	374.50	405.70	436.92	468.12	499.34	530.54	561.74	592.96	624.16	655.38	686.58	717.78	749.00	811.40	873.82	936.24	1,007.76	1,061.08	1,123.48
25	325.08	357.60	390.10	422.62	455.12	487.62	520.14	552.64	585.16	617.66	650.16	682.68	715.18	747.70	780.20	845.22	910.24	975.24	1,048.06	1,105.28	1,170.30
26	338.10	371.90	405.70	439.52	473.32	507.14	540.94	574.76	608.56	642.36	676.18	709.98	743.80	777.60	811.40	879.02	946.64	1,014.26	1,088.38	1,149.50	1,217.10
27	351.10	386.20	421.32	456.42	491.54	526.64	561.74	596.86	631.96	667.08	702.18	737.30	772.40	807.50	842.62	912.84	983.06	1,053.26	1,128.68	1,193.70	1,263.92
28	364.10	400.50	436.92	473.32	509.74	546.14	582.56	618.96	655.38	691.78	728.18	764.60	801.00	837.42	873.82	946.64	1,019.46	1,092.28	1,169.00	1,237.92	1,310.74
29	377.10	414.82	452.52	490.24	527.94	565.64	603.36	641.06	678.78	716.48	754.20	791.90	829.62	867.32	905.04	980.46	1,055.86	1,131.28	1,209.30	1,282.12	1,357.54
30*	390.10	429.12	468.12	507.14	546.14	585.16	624.16	663.18	702.18	741.20	780.20	819.22	858.22	897.24	936.24	1,014.26	1,092.28	1,170.30	1,249.62	1,326.34	1,404.36
31*	403.10	443.42	483.72	524.04	564.34	604.66	644.96	685.28	725.58	765.90	806.20	846.52	886.82	927.14	967.44	1,048.06	1,128.68	1,209.30	1,289.92	1,370.54	1,451.16
32*	416.12	457.72	499.34	540.94	582.56	624.16	665.78	707.38	749.00	790.60	832.22	873.82	915.44	957.04	998.66	1,081.88	1,165.10	1,248.32	1,331.54	1,414.76	1,497.98
33*	429.12	472.02	514.94	557.84	600.76	643.66	686.58	729.48	772.40	815.32	858.22	901.14	944.04	986.96	1,029.86	1,115.68	1,201.50	1,287.32	1,373.14	1,458.96	1,544.80
34*	442.12	486.32	530.54	574.76	618.96	663.18	707.38	751.60	795.80	840.02	884.22	928.44	972.64	1,016.86	1,061.08	1,149.50	1,237.92	1,326.34	1,414.76	1,503.18	1,591.60
35*	455.12	500.64	546.14	591.66	637.16	682.68	728.18	773.70	819.22	864.72	910.24	955.74	1,001.26	1,046.76	1,092.28	1,183.30	1,274.32	1,365.34	1,456.36	1,547.40	1,638.42
36*	468.12	514.94	561.74	608.56	655.38	702.18	749.00	795.80	842.62	889.42	936.24	983.06	1,029.86	1,076.68	1,123.48	1,217.10	1,310.74	1,404.36	1,497.98	1,591.60	1,685.22
37+	EMAIL FOR QUOTE																				

\*Oversize charges will apply

## PRICE AS LISTED



Brushed



Polished



Painted

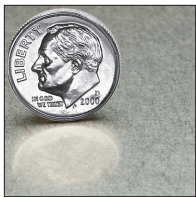

Vibration



Random Arc



Perforated

## OPTIONAL FINISHES - ADD 30%



Brushed  
316 Alloy

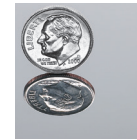

Polished  
316 Alloy



Brushed Gold



Brushed Copper



Brushed  
Medium Bronze



Brushed Black

Titanium Coated



Polished Gold

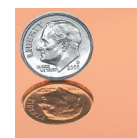

Polished Copper



Polished  
Medium Bronze

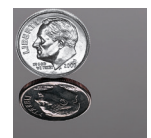

Polished Black



# Your Logo 5" Deep #304 Stainless Steel with Back

**PRICE PER LOGO.** Including standard mounting with pattern.

*Logos smaller than 10" x 10" or with more than 3 pieces email for quote*

SIZE	10"	11"	12"	13"	14"	15"	16"	17"	18"	19"*	20"*	21"*	22"*	23"*	24"*	26"*	28"*	30"*	32"*	34"*	36"*
10"	\$150.94	\$166.04	\$181.12	\$196.22	\$211.32	\$226.40	\$241.50	\$256.60	\$271.68	\$286.78	\$301.86	\$316.96	\$332.06	\$347.14	\$362.24	\$392.42	\$422.62	\$452.80	\$482.98	\$513.18	\$543.36
11	166.04	182.64	199.24	215.84	232.44	249.04	265.64	282.24	298.86	315.46	332.06	348.66	365.26	381.86	398.46	431.66	464.88	498.08	531.28	564.48	597.70
12	181.12	199.24	217.34	235.46	253.58	271.68	289.80	307.90	326.02	344.14	362.24	380.36	398.46	416.58	434.68	470.92	507.14	543.36	579.58	615.80	652.02
13	196.22	215.84	235.46	255.08	274.70	294.32	313.94	333.56	353.18	372.80	392.42	412.04	431.66	451.30	470.92	510.16	549.40	588.64	627.88	667.12	706.36
14	211.32	232.44	253.58	274.70	295.84	316.96	338.10	359.22	380.36	401.48	422.62	443.74	464.88	486.00	507.14	549.40	591.66	633.92	676.18	718.44	760.70
15	226.40	249.04	271.68	294.32	316.96	339.60	362.24	384.88	407.52	430.16	452.80	475.44	498.08	520.72	543.36	588.64	633.92	679.20	724.48	769.76	815.04
16	241.50	265.64	289.80	313.94	338.10	362.24	386.40	410.54	434.68	458.84	482.98	507.14	531.28	555.44	579.58	627.88	676.18	724.48	772.78	821.06	869.36
17	256.60	282.24	307.90	333.56	359.22	384.88	410.54	436.20	461.86	487.52	513.18	538.84	564.48	590.14	615.80	667.12	718.44	769.76	821.06	872.38	923.70
18	271.68	298.86	326.02	353.18	380.36	407.52	434.68	461.86	489.02	516.20	543.36	570.52	597.70	624.86	652.02	706.36	760.70	815.04	869.36	923.70	978.04
19	286.78	315.46	344.14	372.80	401.48	430.16	458.84	487.52	516.20	544.86	573.54	602.22	630.90	659.58	688.26	745.60	802.96	860.32	917.66	975.02	1,032.38
20	301.86	332.06	362.24	392.42	422.62	452.80	482.98	513.18	543.36	573.54	603.72	633.92	664.10	694.28	724.48	784.84	845.22	905.58	965.96	1,026.34	1,086.70
21	316.96	348.66	380.36	412.04	443.74	475.44	507.14	538.84	570.52	602.22	633.92	665.62	697.30	729.00	760.70	824.08	887.48	950.86	1,014.26	1,077.66	1,141.04
22	332.06	365.26	398.46	431.66	464.88	498.08	531.28	564.48	597.70	630.90	664.10	697.30	730.52	763.72	796.92	863.32	929.74	996.14	1,062.56	1,128.96	1,195.38
23	347.14	381.86	416.58	451.30	486.00	520.72	555.44	590.14	624.86	659.58	694.28	729.00	763.72	798.42	833.14	902.58	972.00	1,041.42	1,110.86	1,180.28	1,249.72
24	362.24	398.46	434.68	470.92	507.14	543.36	579.58	615.80	652.02	688.26	724.48	760.70	796.92	833.14	869.36	941.82	1,014.26	1,086.70	1,159.16	1,231.60	1,304.04
25	377.34	415.06	452.80	490.54	528.26	566.00	603.72	641.46	679.20	716.92	754.66	792.40	830.12	867.86	905.58	981.06	1,056.52	1,131.98	1,207.44	1,282.92	1,358.38
26	392.42	431.66	470.92	510.16	549.40	588.64	627.88	667.12	706.36	745.60	784.84	824.08	863.32	902.58	941.82	1,020.30	1,098.78	1,177.26	1,255.74	1,334.24	1,412.72
27	407.52	448.28	489.02	529.78	570.52	611.28	652.02	692.78	733.52	774.28	815.04	855.78	896.54	937.28	978.04	1,059.54	1,141.04	1,222.54	1,304.04	1,385.54	1,467.04
28	422.62	464.88	507.14	549.40	591.66	633.92	676.18	718.44	760.70	802.96	845.22	887.48	929.74	972.00	1,014.26	1,098.78	1,183.30	1,267.82	1,352.34	1,436.86	1,521.38
29	437.70	481.48	525.24	569.02	612.78	656.56	700.32	744.10	787.86	831.64	875.40	919.18	962.94	1,006.72	1,050.48	1,138.02	1,225.56	1,313.10	1,400.64	1,488.18	1,575.72
30*	452.80	498.08	543.36	588.64	633.92	679.20	724.48	769.76	815.04	860.32	905.58	950.86	996.14	1,041.42	1,086.70	1,177.26	1,267.82	1,358.38	1,448.94	1,539.50	1,630.06
31*	467.90	514.68	561.46	608.26	655.04	701.84	748.62	795.42	842.20	888.98	935.78	982.56	1,029.36	1,076.14	1,122.92	1,216.50	1,310.08	1,403.66	1,497.24	1,590.82	1,684.38
32*	482.98	531.28	579.58	627.88	676.18	724.48	772.78	821.06	869.36	917.66	965.96	1,014.26	1,062.56	1,110.86	1,159.16	1,255.74	1,352.34	1,448.94	1,545.54	1,642.12	1,738.72
33*	498.08	547.88	597.70	647.50	697.30	747.12	796.92	846.72	896.54	946.34	996.14	1,045.96	1,095.76	1,145.56	1,195.38	1,294.98	1,394.60	1,494.22	1,593.84	1,693.44	1,793.06
34*	513.18	564.48	615.80	667.12	718.44	769.76	821.06	872.38	923.70	975.02	1,026.34	1,077.66	1,128.96	1,180.28	1,231.60	1,334.24	1,436.86	1,539.50	1,642.12	1,744.76	1,847.40
35*	528.26	581.10	633.92	686.74	739.56	792.40	845.22	898.04	950.86	1,003.70	1,056.52	1,109.34	1,162.18	1,215.00	1,267.82	1,373.48	1,479.12	1,584.78	1,690.42	1,796.08	1,901.72
36*	543.36	597.70	652.02	706.36	760.70	815.04	869.36	923.70	978.04	1,032.38	1,086.70	1,141.04	1,195.38	1,249.72	1,304.04	1,412.72	1,521.38	1,630.06	1,738.72	1,847.40	1,956.06
37+	<b>EMAIL FOR QUOTE</b>																				

\*Oversize charges will apply

## PRICE AS LISTED

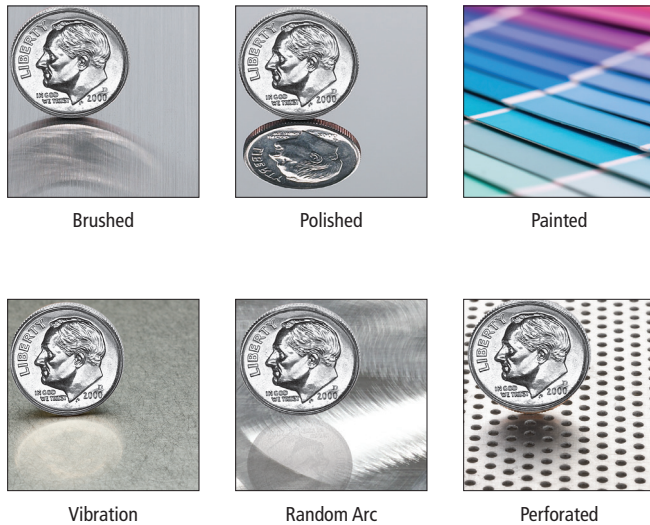

## OPTIONAL FINISHES - ADD 30%



# Your Logo 6" Deep #304 Stainless Steel without Back

**PRICE PER LOGO.** Including standard mounting with pattern.

*Logos smaller than 10" x 10" or with more than 3 pieces email for quote*

SIZE	10"	11"	12"	13"	14"	15"	16"	17"	18"	19"*	20"*	21"*	22"*	23"*	24"*	26"*	28"*	30"*	32"*	34"*	36"*
10"	\$149.55	\$164.50	\$179.45	\$194.42	\$209.37	\$224.32	\$239.27	\$254.22	\$269.17	\$284.15	\$299.10	\$314.05	\$329.00	\$343.95	\$358.90	\$388.82	\$418.72	\$448.62	\$509.94	\$508.44	\$538.34
11	164.50	180.95	197.41	213.86	230.30	246.75	263.19	279.64	296.11	312.55	329.00	345.44	361.89	378.35	394.80	427.69	460.58	493.49	556.28	559.27	592.19
12	179.45	197.41	215.35	233.29	251.23	269.17	287.14	305.08	323.02	340.96	358.90	376.86	394.80	412.74	430.68	466.56	502.46	538.34	602.65	610.13	646.01
13	194.42	213.86	233.29	252.73	272.16	291.62	311.06	330.49	349.93	369.36	388.82	408.25	427.69	447.12	466.56	505.45	544.32	583.22	649.00	660.98	699.85
14	209.37	230.30	251.23	272.16	293.12	314.05	334.98	355.91	376.86	397.79	418.72	439.65	460.58	481.53	502.46	544.32	586.21	628.07	695.36	711.81	753.69
15	224.32	246.75	269.17	291.62	314.05	336.47	358.90	381.34	403.77	426.19	448.62	471.07	493.49	515.92	538.34	583.22	628.07	672.94	741.71	762.66	807.51
16	239.27	263.19	287.14	311.06	334.98	358.90	382.84	406.76	430.68	454.60	478.54	502.46	526.38	550.30	574.25	622.09	669.95	717.79	788.08	813.49	861.35
17	254.22	279.64	305.08	330.49	355.91	381.34	406.76	432.17	457.59	483.03	508.44	533.86	559.27	584.71	610.13	660.98	711.81	762.66	834.42	864.34	915.17
18	269.17	296.11	323.02	349.93	376.86	403.77	430.68	457.59	484.52	511.43	538.34	565.28	592.19	619.10	646.01	699.85	753.69	807.51	880.79	915.17	969.02
19	284.15	312.55	340.96	369.36	397.79	426.19	454.60	483.03	511.43	539.84	568.27	596.67	625.08	653.48	681.91	738.72	795.55	852.38	927.13	966.03	1,022.84
20	299.10	329.00	358.90	388.82	418.72	448.62	478.54	508.44	538.34	568.27	598.17	628.07	657.99	687.89	717.79	777.61	837.41	897.23	973.50	1,016.86	1,076.68
21	314.05	345.44	376.86	408.25	439.65	471.07	502.46	533.86	565.28	596.67	628.07	659.48	690.88	722.27	753.69	816.48	879.29	942.11	1,019.85	1,067.71	1,130.52
22	329.00	361.89	394.80	427.69	460.58	493.49	526.38	559.27	592.19	625.08	657.99	690.88	723.77	756.68	789.57	855.37	921.15	986.96	1,066.22	1,118.54	1,184.34
23	343.95	378.35	412.74	447.12	481.53	515.92	550.30	584.71	619.10	653.48	687.89	722.27	756.68	791.07	825.45	894.24	963.04	1,031.83	1,112.56	1,169.39	1,238.19
24	358.90	394.80	430.68	466.56	502.46	538.34	574.25	610.13	646.01	681.91	717.79	753.69	789.57	825.45	861.35	933.11	1,004.90	1,076.68	1,158.93	1,220.25	1,292.01
25	373.85	411.24	448.62	486.02	523.39	560.77	598.17	635.54	672.94	710.31	747.69	785.09	822.46	859.86	897.23	972.01	1,046.78	1,121.53	1,205.27	1,271.08	1,345.85
26	388.82	427.69	466.56	505.45	544.32	583.22	622.09	660.98	699.85	738.72	777.61	816.48	855.37	894.24	933.11	1,010.88	1,088.64	1,166.40	1,251.64	1,321.93	1,399.67
27	403.77	444.13	484.52	524.89	565.28	605.64	646.01	686.39	726.76	767.15	807.51	847.90	888.26	928.63	969.02	1,049.77	1,130.52	1,211.25	1,297.99	1,372.76	1,453.51
28	418.72	460.58	502.46	544.32	586.21	628.07	669.95	711.81	753.69	795.55	837.41	879.29	921.15	963.04	1,004.90	1,088.64	1,172.38	1,256.13	1,344.35	1,423.61	1,507.36
29	433.67	477.05	520.40	563.78	607.14	650.49	693.87	737.22	780.60	823.96	867.33	910.69	954.07	997.42	1,040.80	1,127.53	1,214.24	1,300.98	1,390.70	1,474.44	1,561.18
30*	448.62	493.49	538.34	583.22	628.07	672.94	717.79	762.66	807.51	852.38	897.23	942.11	986.96	1,031.83	1,076.68	1,166.40	1,256.13	1,345.85	1,437.07	1,525.30	1,615.02
31*	463.57	509.94	556.28	602.65	649.00	695.36	741.71	788.08	834.42	880.79	927.13	973.50	1,019.85	1,066.22	1,112.56	1,205.27	1,297.99	1,390.70	1,483.41	1,576.13	1,668.84
32*	478.54	526.38	574.25	622.09	669.95	717.79	765.65	813.49	861.35	909.19	957.06	1,004.90	1,052.76	1,100.60	1,148.46	1,244.17	1,339.87	1,435.57	1,531.28	1,626.98	1,722.68
33*	493.49	542.83	592.19	641.52	690.88	740.21	789.57	838.91	888.26	937.62	986.96	1,036.32	1,085.65	1,135.01	1,184.34	1,283.04	1,381.73	1,480.42	1,579.12	1,677.81	1,776.52
34*	508.44	559.27	610.13	660.98	711.81	762.66	813.49	864.34	915.17	966.03	1,016.86	1,067.71	1,118.54	1,169.39	1,220.25	1,321.93	1,423.61	1,525.30	1,626.98	1,728.66	1,830.34
35*	523.39	575.74	628.07	680.41	732.74	785.09	837.41	889.76	942.11	994.43	1,046.78	1,099.11	1,151.45	1,203.78	1,256.13	1,360.80	1,465.47	1,570.15	1,674.82	1,779.51	1,884.19
36*	538.34	592.19	646.01	699.85	753.69	807.51	861.35	915.17	969.02	1,022.84	1,076.68	1,130.52	1,184.34	1,238.19	1,292.01	1,399.67	1,507.36	1,615.02	1,722.68	1,830.34	1,938.01
37+	<b>EMAIL FOR QUOTE</b>																				

\*Oversize charges will apply

## PRICE AS LISTED

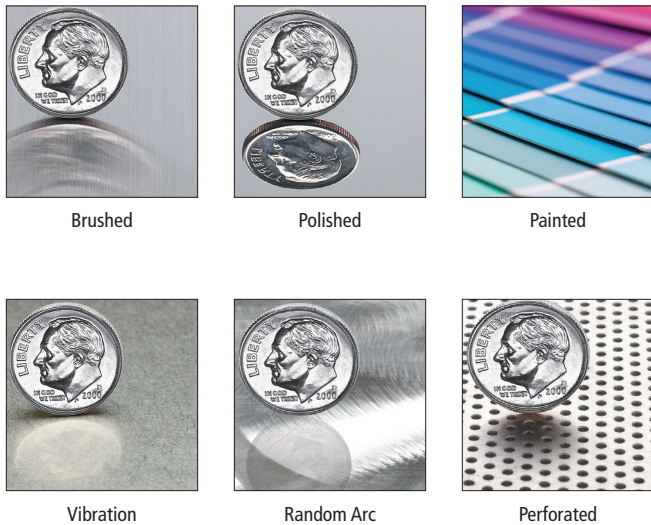

## OPTIONAL FINISHES - ADD 30%



# Your Logo 6" Deep #304 Stainless Steel with Back

**PRICE PER LOGO.** Including standard mounting with pattern.

*Logos smaller than 10" x 10" or with more than 3 pieces email for quote*

SIZE	10"	11"	12"	13"	14"	15"	16"	17"	18"	19"*	20"*	21"*	22"*	23"*	24"*	26"*	28"*	30"*	32"*	34"*	36"*
10"	\$173.59	\$190.95	\$208.29	\$225.66	\$243.02	\$260.36	\$277.73	\$295.09	\$312.44	\$329.80	\$347.14	\$364.51	\$381.87	\$399.22	\$416.58	\$451.29	\$486.02	\$520.72	\$555.43	\$590.16	\$624.87
11	190.95	210.04	229.13	248.22	267.31	286.40	305.49	324.58	343.69	362.78	381.87	400.96	420.05	439.14	458.23	496.41	534.62	572.80	610.98	649.16	687.36
12	208.29	229.13	249.95	270.78	291.62	312.44	333.27	354.09	374.93	395.77	416.58	437.42	458.23	479.07	499.89	541.56	583.22	624.87	666.52	708.17	749.83
13	225.66	248.22	270.78	293.35	315.91	338.47	361.04	383.60	406.16	428.72	451.29	473.85	496.41	519.00	541.56	586.69	631.81	676.94	722.07	767.19	812.32
14	243.02	267.31	291.62	315.91	340.22	364.51	388.82	413.11	437.42	461.71	486.02	510.31	534.62	558.90	583.22	631.81	680.41	729.01	777.61	826.21	874.81
15	260.36	286.40	312.44	338.47	364.51	390.54	416.58	442.62	468.65	494.69	520.72	546.76	572.80	598.83	624.87	676.94	729.01	781.08	833.16	885.23	937.30
16	277.73	305.49	333.27	361.04	388.82	416.58	444.36	472.13	499.89	527.67	555.43	583.22	610.98	638.76	666.52	722.07	777.61	833.16	888.70	944.22	999.77
17	295.09	324.58	354.09	383.60	413.11	442.62	472.13	501.63	531.14	560.65	590.16	619.67	649.16	678.67	708.17	767.19	826.21	885.23	944.22	1,003.24	1,062.26
18	312.44	343.69	374.93	406.16	437.42	468.65	499.89	531.14	562.38	593.63	624.87	656.10	687.36	718.59	749.83	812.32	874.81	937.30	999.77	1,062.26	1,124.75
19	329.80	362.78	395.77	428.72	461.71	494.69	527.67	560.65	593.63	626.59	659.58	692.56	725.54	758.52	791.50	857.44	923.41	989.37	1,055.31	1,121.28	1,187.24
20	347.14	381.87	416.58	451.29	486.02	520.72	555.43	590.16	624.87	659.58	694.28	729.01	763.72	798.43	833.16	902.57	972.01	1,041.42	1,110.86	1,180.30	1,249.71
21	364.51	400.96	437.42	473.85	510.31	546.76	583.22	619.67	656.10	692.56	729.01	765.47	801.90	838.35	874.81	947.70	1,020.61	1,093.49	1,166.40	1,239.31	1,312.20
22	381.87	420.05	458.23	496.41	534.62	572.80	610.98	649.16	687.36	725.54	763.72	801.90	840.10	878.28	916.46	992.82	1,069.21	1,145.57	1,221.95	1,298.31	1,374.69
23	399.22	439.14	479.07	519.00	558.90	598.83	638.76	678.67	718.59	758.52	798.43	838.35	878.28	918.19	958.12	1,037.97	1,117.80	1,197.64	1,277.49	1,357.33	1,437.18
24	416.58	458.23	499.89	541.56	583.22	624.87	666.52	708.17	749.83	791.50	833.16	874.81	916.46	958.12	999.77	1,083.10	1,166.40	1,249.71	1,333.04	1,416.34	1,499.65
25	433.95	477.32	520.72	564.13	607.50	650.90	694.28	737.68	781.08	824.46	867.86	911.26	954.64	998.04	1,041.42	1,128.22	1,215.00	1,301.78	1,388.56	1,475.36	1,562.14
26	451.29	496.41	541.56	586.69	631.81	676.94	722.07	767.19	812.32	857.44	902.57	947.70	992.82	1,037.97	1,083.10	1,173.35	1,263.60	1,353.85	1,444.11	1,534.38	1,624.63
27	468.65	515.53	562.38	609.25	656.10	702.98	749.83	796.70	843.55	890.43	937.30	984.15	1,031.03	1,077.88	1,124.75	1,218.48	1,312.20	1,405.93	1,499.65	1,593.38	1,687.10
28	486.02	534.62	583.22	631.81	680.41	729.01	777.61	826.21	874.81	923.41	972.01	1,020.61	1,069.21	1,117.80	1,166.40	1,263.60	1,360.80	1,458.00	1,555.20	1,652.39	1,749.59
29	503.36	553.71	604.03	654.38	704.70	755.05	805.37	855.72	906.04	956.39	1,006.71	1,057.06	1,107.39	1,157.73	1,208.06	1,308.73	1,409.40	1,510.07	1,610.74	1,711.41	1,812.08
30*	520.72	572.80	624.87	676.94	729.01	781.08	833.16	885.23	937.30	989.37	1,041.42	1,093.49	1,145.57	1,197.64	1,249.71	1,353.85	1,458.00	1,562.14	1,666.29	1,770.43	1,874.57
31*	538.09	591.89	645.68	699.50	753.30	807.12	860.92	914.74	968.53	1,022.33	1,076.15	1,129.95	1,183.77	1,237.57	1,291.36	1,398.98	1,506.60	1,614.21	1,721.83	1,829.45	1,937.04
32*	555.43	610.98	666.52	722.07	777.61	833.16	888.70	944.22	999.77	1,055.31	1,110.86	1,166.40	1,221.95	1,277.49	1,333.04	1,444.11	1,555.20	1,666.29	1,777.38	1,888.44	1,999.53
33*	572.80	630.07	687.36	744.63	801.90	859.19	916.46	973.73	1,031.03	1,088.30	1,145.57	1,202.86	1,260.13	1,317.40	1,374.69	1,489.23	1,603.79	1,718.36	1,832.92	1,947.46	2,062.02
34*	590.16	649.16	708.17	767.19	826.21	885.23	944.22	1,003.24	1,062.26	1,121.28	1,180.30	1,239.31	1,298.31	1,357.33	1,416.34	1,534.38	1,652.39	1,770.43	1,888.44	2,006.48	2,124.51
35*	607.50	668.27	729.01	789.76	850.50	911.26	972.01	1,032.75	1,093.49	1,154.26	1,215.00	1,275.75	1,336.51	1,397.25	1,458.00	1,579.51	1,700.99	1,822.50	1,943.99	2,065.50	2,186.98
36*	624.87	687.36	749.83	812.32	874.81	937.30	999.77	1,062.26	1,124.75	1,187.24	1,249.71	1,312.20	1,374.69	1,437.18	1,499.65	1,624.63	1,749.59	1,874.57	1,999.53	2,124.51	2,249.47
37+	<b>EMAIL FOR QUOTE</b>																				

\*Oversize charges will apply

## PRICE AS LISTED



Brushed

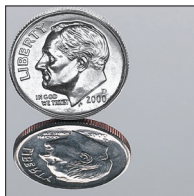

Polished

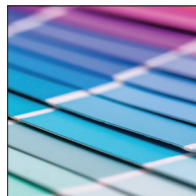

Painted

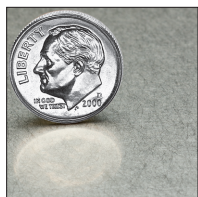

Vibration



Random Arc

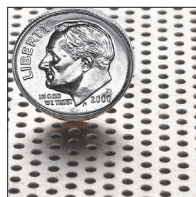

Perforated

## OPTIONAL FINISHES - ADD 30%

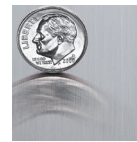

Brushed 316 Alloy

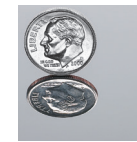

Polished 316 Alloy



Brushed Gold



Brushed Copper

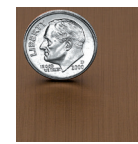

Brushed Medium Bronze



Brushed Black



Polished Gold

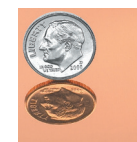

Polished Copper

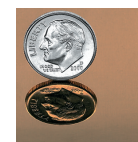

Polished Medium Bronze

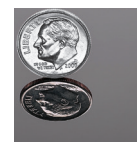

Polished Black



# Fabricated Aluminum - Without Back

**PRICE PER LETTER INCLUDES STANDARD MOUNTING AND PATTERN**

## PRICE AS LISTED



Brushed

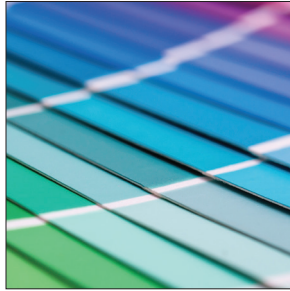

Painted

### Pricing Notes:

- Price includes stud mount and installation pattern
- Lower case is 90% of the corresponding Upper Case price
- Small punctuation, such as a comma, period and dash are 33% of the Upper Case price
- Block, serif & script styles - SAME PRICE
- Returns painted different color than face add 15%

SIZE	1" DEEP	1-1/2" DEEP	2" DEEP	3" DEEP	3-1/2" DEEP	4" DEEP	5" DEEP	6" DEEP
16"	\$142	\$153	\$176	\$200	\$208	\$216	\$237	\$257
17	149	160	187	211	221	230	253	275
18	160	174	202	226	234	241	263	286
19	174	184	216	243	247	251	274	297
20	180	197	230	256	261	265	283	307
21	192	209	239	257	267	276	292	317
22	206	226	252	271	280	288	307	332
23	223	246	276	293	303	313	331	356
24	247	276	306	326	336	345	366	395
25	270	304	331	351	361	370	397	428
26	295	326	348	368	379	390	429	465
27	312	339	361	384	395	405	445	483
28	324	351	374	398	410	421	463	501
29	336	364	387	412	424	436	478	519
30*	347	376	400	426	439	451	496	538
31*	361	391	415	442	455	467	513	557
32*	375	406	429	456	470	484	530	575
33*	390	422	446	477	490	502	551	598
34*	405	438	462	493	507	521	572	621
35*	421	455	480	511	527	542	595	646
36*	437	473	498	530	546	562	618	670
37*		492	517	550	567	583	641	696
38*		511	537	571	588	605	665	723
39*		531	558	593	611	628	690	751
40*		552	580	615	633	651	716	780
42*		597	626	662	681	700	771	841
44*		644	675	713	733	753	830	907
46*		695	728	768	789	810	893	978
48*		750	785	827	849	871	962	1,055
50*			846	890	913	936	1,035	1,138
52*			913	958	983	1,007	1,114	1,227
54*			985	1,031	1,057	1,083	1,199	1,323
56*			1,062	1,110	1,137	1,164	1,291	1,427
58*			1,145	1,195	1,224	1,252	1,389	1,539
60*			1,235	1,286	1,316	1,346	1,495	1,659
61"+	<b>EMAIL FOR QUOTE</b>							

LETTER HEIGHT - MAX DIMENSION

\*Oversize charges will apply

## OPTIONAL ANODIZED FINISHES - EMAIL FOR QUOTE



Clear

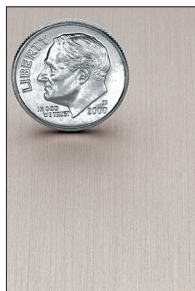

Champagne



Gold



Light Bronze



Medium Bronze



Dark Bronze



Black

# Fabricated Aluminum - With Metal Back

PRICE PER LETTER INCLUDES STANDARD MOUNTING AND PATTERN

## PRICE AS LISTED



Brushed

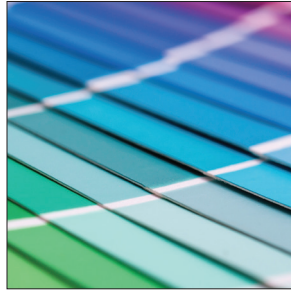

Painted

### Pricing Notes:

- Price includes stud mount and installation pattern
- Lower case is 90% of the corresponding Upper Case price
- Small punctuation, such as a comma, period and dash are 33% of the Upper Case price
- Block, serif & script styles - SAME PRICE
- Returns painted different color than face add 15%

LETTER HEIGHT - MAX DIMENSION

SIZE	1" DEEP	1-1/2" DEEP	2" DEEP	3" DEEP	3-1/2" DEEP	4" DEEP	5" DEEP	6" DEEP
16"	\$172	\$184	\$215	\$241	\$251	\$260	\$296	\$321
17	181	196	227	257	268	279	317	347
18	196	212	246	275	283	290	327	357
19	212	225	262	294	299	304	340	369
20	225	240	276	306	313	319	354	380
21	235	256	285	308	319	330	364	389
22	250	270	298	322	334	345	382	407
23	265	289	314	339	351	363	403	430
24	295	322	346	368	380	391	430	473
25	324	354	373	398	410	422	467	513
26	348	377	402	433	444	454	510	554
27	371	402	426	457	473	489	547	590
28	394	427	446	479	497	514	579	617
29	410	442	463	497	514	531	602	646
30*	426	460	479	514	532	549	620	666
31*			496	534	552	570	643	691
32*			512	552	572	592	668	719
33*			529	572	593	614	694	748
34*			548	592	615	638	721	777
35*			564	614	639	663	749	809
36*			586	637	662	687	777	840
37*			617	668	694	720	813	878
38*			650	701	728	755	850	918
39*			684	735	764	792	889	960
40*			720	771	801	831	930	1,004
42*			798	848	881	913	1,018	1,098
44*			884	932	968	1,003	1,114	1,200
46*				1,024	1,064	1,103	1,219	1,311
48*				1,126	1,169	1,212	1,334	1,432
50*				1,238	1,286	1,333	1,459	1,565
52*				1,361	1,413	1,465	1,596	1,710
54*				1,496	1,553	1,610	1,745	1,868
56*				1,644	1,707	1,770	1,909	2,041
58*				1,806	1,876	1,945	2,087	2,229
60*				1,984	2,061	2,137	2,282	2,435
61" +	EMAIL FOR QUOTE							

\*Oversize charges will apply

## OPTIONAL ANODIZED FINISHES - EMAIL FOR QUOTE



Clear

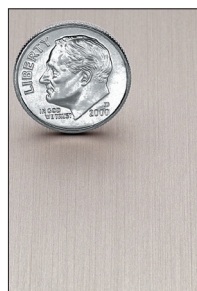

Champagne



Gold



Light Bronze



Medium Bronze

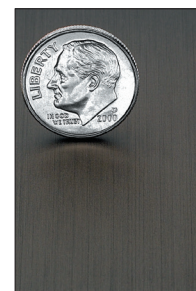

Dark Bronze



Black

# Your Logo 1" Deep Aluminum without Back

**PRICE PER LOGO.** Including standard mounting with pattern.

*Logos smaller than 10" x 10" or with more than 3 pieces email for quote*

Size	16"	17"	18"	19"	20"	21"	22"	23"	24"	25"	26**	27"	28**	29"	30**	31"	32**	33"	34**	35"	36**
16"	\$153.64	\$163.25	\$172.85	\$182.45	\$192.05	\$201.66	\$211.26	\$220.86	\$230.46	\$240.07	\$249.67	\$259.27	\$268.87	\$278.48	\$288.08	\$297.68	\$307.28	\$316.89	\$326.49	\$336.09	\$345.69
17	163.25	173.45	183.65	193.86	204.06	214.26	224.46	234.67	244.87	255.07	265.27	275.48	285.68	295.88	306.08	316.29	326.49	336.69	346.90	357.10	367.30
18	172.85	183.65	194.46	205.26	216.06	226.86	237.67	248.47	259.27	270.08	280.88	291.68	302.48	313.29	324.09	334.89	345.69	356.50	367.30	378.10	388.91
19	182.45	193.86	205.26	216.66	228.06	239.47	250.87	262.27	273.68	285.08	296.48	307.89	319.29	330.69	342.09	353.50	364.90	376.30	387.71	399.11	410.51
20	192.05	204.06	216.06	228.06	240.07	252.07	264.07	276.08	288.08	300.08	312.09	324.09	336.09	348.10	360.10	372.10	384.10	396.11	408.11	420.11	432.12
21	201.66	214.26	226.86	239.47	252.07	264.67	277.28	289.88	302.48	315.09	327.69	340.29	352.90	365.50	378.10	390.71	403.31	415.91	428.52	441.12	453.72
22	211.26	224.46	237.67	250.87	264.07	277.28	290.48	303.68	316.89	330.09	343.29	356.50	369.70	382.90	396.11	409.31	422.51	435.72	448.92	462.13	475.33
23	220.86	234.67	248.47	262.27	276.08	289.88	303.68	317.49	331.29	345.09	358.90	372.70	386.51	400.31	414.11	427.92	441.72	455.52	469.33	483.13	496.93
24	230.46	244.87	259.27	273.68	288.08	302.48	316.89	331.29	345.69	360.10	374.50	388.91	403.31	417.71	432.12	446.52	460.92	475.33	489.73	504.14	518.54
25	240.07	255.07	270.08	285.08	300.08	315.09	330.09	345.09	360.10	375.10	390.11	405.11	420.11	435.12	450.12	465.13	480.13	495.13	510.14	525.14	540.15
26	249.67	265.27	280.88	296.48	312.09	327.69	343.29	358.90	374.50	390.11	405.71	421.31	436.92	452.52	468.13	483.73	499.33	514.94	530.54	546.15	561.75
27	259.27	275.48	291.68	307.89	324.09	340.29	356.50	372.70	388.91	405.11	421.31	437.52	453.72	469.93	486.13	502.34	518.54	534.74	550.95	567.15	583.36
28	268.87	285.68	302.48	319.29	336.09	352.90	369.70	386.51	403.31	420.11	436.92	453.72	470.53	487.33	504.14	520.94	537.74	554.55	571.35	588.16	604.96
29	278.48	295.88	313.29	330.69	348.10	365.50	382.90	400.31	417.71	435.12	452.52	469.93	487.33	504.74	522.14	539.55	556.95	574.35	591.76	609.16	626.57
30*	288.08	306.08	324.09	342.09	360.10	378.10	396.11	414.11	432.12	450.12	468.13	486.13	504.14	522.14	540.15	558.15	576.15	594.16	612.16	630.17	648.17
31*	297.68	316.29	334.89	353.50	372.10	390.71	409.31	427.92	446.52	465.13	483.73	502.34	520.94	539.55	558.15	576.76	595.36	613.96	632.57	651.17	669.78
32*	307.28	326.49	345.69	364.90	384.10	403.31	422.51	441.72	460.92	480.13	499.33	518.54	537.74	556.95	576.15	595.36	614.56	633.77	652.97	672.18	691.38
33*	316.89	336.69	356.50	376.30	396.11	415.91	435.72	455.52	475.33	495.13	514.94	534.74	554.55	574.35	594.16	613.96	633.77	653.58	673.38	693.19	712.99
34*	326.49	346.90	367.30	387.71	408.11	428.52	448.92	469.33	489.73	510.14	530.54	550.95	571.35	591.76	612.16	632.57	652.97	673.38	693.79	714.19	734.60
35*	336.09	357.10	378.10	399.11	420.11	441.12	462.13	483.13	504.14	525.14	546.15	567.15	588.16	609.16	630.17	651.17	672.18	693.19	714.19	735.20	756.20
36*	345.69	367.30	388.91	410.51	432.12	453.72	475.33	496.93	518.54	540.15	561.75	583.36	604.96	626.57	648.17	669.78	691.38	712.99	734.60	756.20	777.81
38*	364.90	387.71	410.51	433.32	456.12	478.93	501.74	524.54	547.35	570.15	592.96	615.77	638.57	661.38	684.18	706.99	729.79	752.60	775.41	798.21	821.02
40*	384.10	408.11	432.12	456.12	480.13	504.14	528.14	552.15	576.15	600.16	624.17	648.17	672.18	696.19	720.19	744.20	768.20	792.21	816.22	840.22	864.23
42*	403.31	428.52	453.72	478.93	504.14	529.34	554.55	579.76	604.96	630.17	655.38	680.58	705.79	731.00	756.20	781.41	806.61	831.82	857.03	882.23	907.44
44*	422.51	448.92	475.33	501.74	528.14	554.55	580.96	607.36	633.77	660.18	686.58	712.99	739.40	765.80	792.21	818.62	845.02	871.43	897.84	924.25	950.65
46*	441.72	469.33	496.93	524.54	552.15	579.76	607.36	634.97	662.58	690.18	717.79	745.40	773.01	800.61	828.22	855.83	883.43	911.04	938.65	966.26	993.86
48*	460.92	489.73	518.54	547.35	576.15	604.96	633.77	662.58	691.38	720.19	749.00	777.81	806.61	835.42	864.23	893.04	921.84	950.65	979.46	1,008.27	1,037.07
50*	480.13	510.14	540.15	570.15	600.16	630.17	660.18	690.18	720.19	750.20	780.21	810.22	840.22	870.23	900.24	930.25	960.25	990.26	1,020.27	1,050.28	1,080.29
52*	499.33	530.54	561.75	592.96	624.17	655.38	686.58	717.79	749.00	780.21	811.42	842.62	873.83	905.04	936.25	967.46	998.66	1,029.87	1,061.08	1,092.29	1,123.50
54*	518.54	550.95	583.36	615.77	648.17	680.58	712.99	745.40	777.81	810.22	842.62	875.03	907.44	939.85	972.26	1,004.67	1,037.07	1,069.48	1,101.89	1,134.30	1,166.71
56*	537.74	571.35	604.96	638.57	672.18	705.79	739.40	773.01	806.61	840.22	873.83	907.44	941.05	974.66	1,008.27	1,041.88	1,075.48	1,109.09	1,142.70	1,176.31	1,209.92
58*	556.95	591.76	626.57	661.38	696.19	731.00	765.80	800.61	835.42	870.23	905.04	939.85	974.66	1,009.47	1,044.28	1,079.09	1,113.89	1,148.70	1,183.51	1,218.32	1,253.13
60*	576.15	612.16	648.17	684.18	720.19	756.20	792.21	828.22	864.23	900.24	936.25	972.26	1,008.27	1,044.28	1,080.29	1,116.30	1,152.30	1,188.31	1,224.32	1,260.33	1,296.34
61+	EMAIL FOR QUOTE																				

\*Oversize charges will apply

## PRICE AS LISTED



Brushed

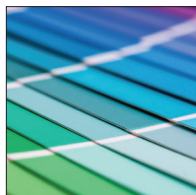

Painted

## OPTIONAL ANODIZED FINISHES - EMAIL FOR QUOTE



Clear

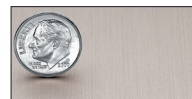

Champagne



Gold



Black



Light Bronze



Medium Bronze



Dark Bronze



## Your Logo 1" Deep Aluminum without Back

**PRICE PER LOGO.** Including standard mounting with pattern.

*Logos smaller than 10" x 10" or with more than 3 pieces email for quote*

Size	37"*	38"*	39"*	40"*	41"*	42"*	43"*	44"*	45"*	46"*	47"*	48"	49"*	50"	52"*	54"	56"*	58"	60"*
16"	\$355.30	\$364.90	\$374.50	\$384.10	\$393.71	\$403.31	\$412.91	\$422.51	\$432.12	\$441.72	\$451.32	\$460.92	\$470.53	\$480.13	\$499.33	\$518.54	\$537.74	\$556.95	\$576.15
17	377.50	387.71	397.91	408.11	418.31	428.52	438.72	448.92	459.12	469.33	479.53	489.73	499.94	510.14	530.54	550.95	571.35	591.76	612.16
18	399.71	410.51	421.31	432.12	442.92	453.72	464.53	475.33	486.13	496.93	507.74	518.54	529.34	540.15	561.75	583.36	604.96	626.57	648.17
19	421.91	433.32	444.72	456.12	467.53	478.93	490.33	501.74	513.14	524.54	535.94	547.35	558.75	570.15	592.96	615.77	638.57	661.38	684.18
20	444.12	456.12	468.13	480.13	492.13	504.14	516.14	528.14	540.15	552.15	564.15	576.15	588.16	600.16	624.17	648.17	672.18	696.19	720.19
21	466.33	478.93	491.53	504.14	516.74	529.34	541.95	554.55	567.15	579.76	592.36	604.96	617.57	630.17	655.38	680.58	705.79	731.00	756.20
22	488.53	501.74	514.94	528.14	541.35	554.55	567.75	580.96	594.16	607.36	620.57	633.77	646.97	660.18	686.58	712.99	739.40	765.80	792.21
23	510.74	524.54	538.35	552.15	565.95	579.76	593.56	607.36	621.17	634.97	648.77	662.58	676.38	690.18	717.79	745.40	773.01	800.61	828.22
24	532.94	547.35	561.75	576.15	590.56	604.96	619.37	633.77	648.17	662.58	676.98	691.38	705.79	720.19	749.00	777.81	806.61	835.42	864.23
25	555.15	570.15	585.16	600.16	615.17	630.17	645.17	660.18	675.18	690.18	705.19	720.19	735.20	750.20	780.21	810.22	840.22	870.23	900.24
26	577.36	592.96	608.56	624.17	639.77	655.38	670.98	686.58	702.19	717.79	733.40	749.00	764.60	780.21	811.42	842.62	873.83	905.04	936.25
27	599.56	615.77	631.97	648.17	664.38	680.58	696.79	712.99	729.19	745.40	761.60	777.81	794.01	810.22	842.62	875.03	907.44	939.85	972.26
28	621.77	638.57	655.38	672.18	688.98	705.79	722.59	739.40	756.20	773.01	789.81	806.61	823.42	840.22	873.83	907.44	941.05	974.66	1,008.27
29	643.97	661.38	678.78	696.19	713.59	731.00	748.40	765.80	783.21	800.61	818.02	835.42	852.83	870.23	905.04	939.85	974.66	1,009.47	1,044.28
30*	666.18	684.18	702.19	720.19	738.20	756.20	774.21	792.21	810.22	828.22	846.23	864.23	882.23	900.24	936.25	972.26	1,008.27	1,044.28	1,080.29
31*	688.38	706.99	725.59	744.20	762.80	781.41	800.01	818.62	837.22	855.83	874.43	893.04	911.64	930.25	967.46	1,004.67	1,041.88	1,079.09	1,116.30
32*	710.59	729.79	749.00	768.20	787.41	806.61	825.82	845.02	864.23	883.43	902.64	921.84	941.05	960.25	998.66	1,037.07	1,075.48	1,113.89	1,152.30
33*	732.80	752.60	772.41	792.21	812.02	831.82	851.63	871.43	891.24	911.04	930.85	950.65	970.46	990.26	1,029.87	1,069.48	1,109.09	1,148.70	1,188.31
34*	755.00	775.41	795.81	816.22	836.62	857.03	877.43	897.84	918.24	938.65	959.05	979.46	999.87	1,020.27	1,061.08	1,101.89	1,142.70	1,183.51	1,224.32
35*	777.21	798.21	819.22	840.22	861.23	882.23	903.24	924.25	945.25	966.26	987.26	1,008.27	1,029.27	1,050.28	1,092.29	1,134.30	1,176.31	1,218.32	1,260.33
36*	799.41	821.02	842.62	864.23	885.84	907.44	929.05	950.65	972.26	993.86	1,015.47	1,037.07	1,058.68	1,080.29	1,123.50	1,166.71	1,209.92	1,253.13	1,296.34
38*	843.82	866.63	889.44	912.24	935.05	957.85	980.66	1,003.47	1,026.27	1,049.08	1,071.88	1,094.69	1,117.50	1,140.30	1,185.91	1,231.53	1,277.14	1,322.75	1,368.36
40*	888.24	912.24	936.25	960.25	984.26	1,008.27	1,032.27	1,056.28	1,080.29	1,104.29	1,128.30	1,152.30	1,176.31	1,200.32	1,248.33	1,296.34	1,344.35	1,392.37	1,440.38
42*	932.65	957.85	983.06	1,008.27	1,033.47	1,058.68	1,083.89	1,109.09	1,134.30	1,159.51	1,184.71	1,209.92	1,235.13	1,260.33	1,310.75	1,361.16	1,411.57	1,461.99	1,512.40
44*	977.06	1,003.47	1,029.87	1,056.28	1,082.69	1,109.09	1,135.50	1,161.91	1,188.31	1,214.72	1,241.13	1,267.53	1,293.94	1,320.35	1,373.16	1,425.98	1,478.79	1,531.60	1,584.42
46*	1,021.47	1,049.08	1,076.69	1,104.29	1,131.90	1,159.51	1,187.11	1,214.72	1,242.33	1,269.94	1,297.54	1,325.15	1,352.76	1,380.36	1,435.58	1,490.79	1,546.01	1,601.22	1,656.44
48*	1,065.88	1,094.69	1,123.50	1,152.30	1,181.11	1,209.92	1,238.73	1,267.53	1,296.34	1,325.15	1,353.96	1,382.76	1,411.57	1,440.38	1,497.99	1,555.61	1,613.22	1,670.84	1,728.45
50*	1,110.29	1,140.30	1,170.31	1,200.32	1,230.33	1,260.33	1,290.34	1,320.35	1,350.36	1,380.36	1,410.37	1,440.38	1,470.39	1,500.40	1,560.41	1,620.43	1,680.44	1,740.46	1,800.47
52*	1,154.71	1,185.91	1,217.12	1,248.33	1,279.54	1,310.75	1,341.95	1,373.16	1,404.37	1,435.58	1,466.79	1,497.99	1,529.20	1,560.41	1,622.83	1,685.24	1,747.66	1,810.08	1,872.49
54*	1,199.12	1,231.53	1,263.93	1,296.34	1,328.75	1,361.16	1,393.57	1,425.98	1,458.38	1,490.79	1,523.20	1,555.61	1,588.02	1,620.43	1,685.24	1,750.06	1,814.88	1,879.69	1,944.51
56*	1,243.53	1,277.14	1,310.75	1,344.35	1,377.96	1,411.57	1,445.18	1,478.79	1,512.40	1,546.01	1,579.62	1,613.22	1,646.83	1,680.44	1,747.66	1,814.88	1,882.09	1,949.31	2,016.53
58*	1,287.94	1,322.75	1,357.56	1,392.37	1,427.18	1,461.99	1,496.79	1,531.60	1,566.41	1,601.22	1,636.03	1,670.84	1,705.65	1,740.46	1,810.08	1,879.69	1,949.31	2,018.93	2,088.55
60*	1,332.35	1,368.36	1,404.37	1,440.38	1,476.39	1,512.40	1,548.41	1,584.42	1,620.43	1,656.44	1,692.45	1,728.45	1,764.46	1,800.47	1,872.49	1,944.51	2,016.53	2,088.55	2,160.57
61+	EMAIL FOR QUOTE																		

\*Oversize charges will apply

### PRICE AS LISTED



Brushed

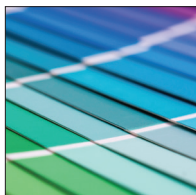

Painted

### OPTIONAL ANODIZED FINISHES - EMAIL FOR QUOTE



Clear



Champagne



Gold



Black



Light Bronze



Medium Bronze



Dark Bronze

# Your Logo 1" Deep Aluminum with Back

**PRICE PER LOGO.** Including standard mounting with pattern.

*Logos smaller than 10" x 10" or with more than 3 pieces email for quote*

Size	16"	17"	18"	19"	20"	21"	22"	23"	24"	25"	26**	27"	28**	29"	30**	31"	32**	33"	34**	35"	36**
16"	\$175.53	\$186.51	\$197.48	\$208.45	\$219.42	\$230.39	\$241.36	\$252.33	\$263.30	\$274.27	\$285.24	\$296.21	\$307.18	\$318.15	\$329.12	\$340.09	\$351.06	\$362.04	\$373.01	\$383.98	\$394.95
17	186.51	198.16	209.82	221.47	233.13	244.79	256.44	268.10	279.76	291.41	303.07	314.72	326.38	338.04	349.69	361.35	373.01	384.66	396.32	407.98	419.63
18	197.48	209.82	222.16	234.50	246.84	259.19	271.53	283.87	296.21	308.55	320.90	333.24	345.58	357.92	370.26	382.61	394.95	407.29	419.63	431.97	444.32
19	208.45	221.47	234.50	247.53	260.56	273.58	286.61	299.64	312.67	325.70	338.72	351.75	364.78	377.81	390.83	403.86	416.89	429.92	442.94	455.97	469.00
20	219.42	233.13	246.84	260.56	274.27	287.98	301.70	315.41	329.12	342.84	356.55	370.26	383.98	397.69	411.40	425.12	438.83	452.54	466.26	479.97	493.68
21	230.39	244.79	259.19	273.58	287.98	302.38	316.78	331.18	345.58	359.98	374.38	388.78	403.18	417.57	431.97	446.37	460.77	475.17	489.57	503.97	518.37
22	241.36	256.44	271.53	286.61	301.70	316.78	331.87	346.95	362.04	377.12	392.20	407.29	422.37	437.46	452.54	467.63	482.71	497.80	512.88	527.97	543.05
23	252.33	268.10	283.87	299.64	315.41	331.18	346.95	362.72	378.49	394.26	410.03	425.80	441.57	457.34	473.11	488.88	504.65	520.42	536.19	551.96	567.73
24	263.30	279.76	296.21	312.67	329.12	345.58	362.04	378.49	394.95	411.40	427.86	444.32	460.77	477.23	493.68	510.14	526.59	543.05	559.51	575.96	592.42
25	274.27	291.41	308.55	325.70	342.84	359.98	377.12	394.26	411.40	428.55	445.69	462.83	479.97	497.11	514.25	531.39	548.54	565.68	582.82	599.96	617.10
26	285.24	303.07	320.90	338.72	356.55	374.38	392.20	410.03	427.86	445.69	463.51	481.34	499.17	517.00	534.82	552.65	570.48	588.30	606.13	623.96	641.79
27	296.21	314.72	333.24	351.75	370.26	388.78	407.29	425.80	444.32	462.83	481.34	499.85	518.37	536.88	555.39	573.91	592.42	610.93	629.44	647.96	666.47
28	307.18	326.38	345.58	364.78	383.98	403.18	422.37	441.57	460.77	479.97	499.17	518.37	537.57	556.76	575.96	595.16	614.36	633.56	652.76	671.96	691.15
29	318.15	338.04	357.92	377.81	397.69	417.57	437.46	457.34	477.23	497.11	517.00	536.88	556.76	576.65	596.53	616.42	636.30	656.19	676.07	695.95	715.84
30*	329.12	349.69	370.26	390.83	411.40	431.97	452.54	473.11	493.68	514.25	534.82	555.39	575.96	596.53	617.10	637.67	658.24	678.81	699.38	719.95	740.52
31*	340.09	361.35	382.61	403.86	425.12	446.37	467.63	488.88	510.14	531.39	552.65	573.91	595.16	616.42	637.67	658.93	680.18	701.44	722.69	743.95	765.21
32*	351.06	373.01	394.95	416.89	438.83	460.77	482.71	504.65	526.59	548.54	570.48	592.42	614.36	636.30	658.24	680.18	702.12	724.07	746.01	767.95	789.89
33*	362.04	384.66	407.29	429.92	452.54	475.17	497.80	520.42	543.05	565.68	588.30	610.93	633.56	656.19	678.81	701.44	724.07	746.69	769.32	791.95	814.57
34*	373.01	396.32	419.63	442.94	466.26	489.57	512.88	536.19	559.51	582.82	606.13	629.44	652.76	676.07	699.38	722.69	746.01	769.32	792.63	815.95	839.26
35*	383.98	407.98	431.97	455.97	479.97	503.97	527.97	551.96	575.96	599.96	623.96	647.96	671.96	695.95	719.95	743.95	767.95	791.95	815.95	839.94	863.94
36*	394.95	419.63	444.32	469.00	493.68	518.37	543.05	567.73	592.42	617.10	641.79	666.47	691.15	715.84	740.52	765.21	789.89	814.57	839.26	863.94	888.63
38*	416.89	442.94	469.00	495.05	521.11	547.16	573.22	599.28	625.33	651.39	677.44	703.50	729.55	755.61	781.66	807.72	833.77	859.83	885.88	911.94	937.99
40*	438.83	466.26	493.68	521.11	548.54	575.96	603.39	630.82	658.24	685.67	713.10	740.52	767.95	795.38	822.80	850.23	877.65	905.08	932.51	959.93	987.36
42*	460.77	489.57	518.37	547.16	575.96	604.76	633.56	662.36	691.15	719.95	748.75	777.55	806.35	835.14	863.94	892.74	921.54	950.34	979.13	1,007.93	1,036.73
44*	482.71	512.88	543.05	573.22	603.39	633.56	663.73	693.90	724.07	754.24	784.40	814.57	844.74	874.91	905.08	935.25	965.42	995.59	1,025.76	1,055.93	1,086.10
46*	504.65	536.19	567.73	599.28	630.82	662.36	693.90	725.44	756.98	788.52	820.06	851.60	883.14	914.68	946.22	977.76	1,009.30	1,040.84	1,072.38	1,103.92	1,135.46
48*	526.59	559.51	592.42	625.33	658.24	691.15	724.07	756.98	789.89	822.80	855.71	888.63	921.54	954.45	987.36	1,020.27	1,053.18	1,086.10	1,119.01	1,151.92	1,184.83
50*	548.54	582.82	617.10	651.39	685.67	719.95	754.24	788.52	822.80	857.09	891.37	925.65	959.93	994.22	1,028.50	1,062.78	1,097.07	1,131.35	1,165.63	1,199.92	1,234.20
52*	570.48	606.13	641.79	677.44	713.10	748.75	784.40	820.06	855.71	891.37	927.02	962.68	998.33	1,033.99	1,069.64	1,105.30	1,140.95	1,176.60	1,212.26	1,247.91	1,283.57
54*	592.42	629.44	666.47	703.50	740.52	777.55	814.57	851.60	888.63	925.65	962.68	999.70	1,036.73	1,073.75	1,110.78	1,147.81	1,184.83	1,221.86	1,258.88	1,295.91	1,332.94
56*	614.36	652.76	691.15	729.55	767.95	806.35	844.74	883.14	921.54	959.93	998.33	1,036.73	1,075.13	1,113.52	1,151.92	1,190.32	1,228.71	1,267.11	1,305.51	1,343.91	1,382.30
58*	636.30	676.07	715.84	755.61	795.38	835.14	874.91	914.68	954.45	994.22	1,033.99	1,073.75	1,113.52	1,153.29	1,193.06	1,232.83	1,272.60	1,312.37	1,352.13	1,391.90	1,431.67
60*	658.24	699.38	740.52	781.66	822.80	863.94	905.08	946.22	987.36	1,028.50	1,069.64	1,110.78	1,151.92	1,193.06	1,234.20	1,275.34	1,316.48	1,357.62	1,398.76	1,439.90	1,481.04
61+	<b>EMAIL FOR QUOTE</b>																				

\*Oversize charges will apply

## PRICE AS LISTED



Brushed

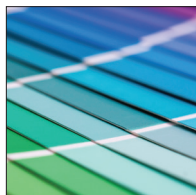

Painted

## OPTIONAL ANODIZED FINISHES - EMAIL FOR QUOTE



Clear



Champagne



Gold



Black



Light Bronze



Medium Bronze



Dark Bronze

# Your Logo 1" Deep Aluminum with Back

**PRICE PER LOGO.** Including standard mounting with pattern.

*Logos smaller than 10" x 10" or with more than 3 pieces email for quote*

Size	37"*	38"*	39"*	40"*	41"*	42"*	43"*	44"*	45"*	46"*	47"*	48"	49"*	50"	52"*	54"	56"*	58"	60"*
16"	\$405.92	\$416.89	\$427.86	\$438.83	\$449.80	\$460.77	\$471.74	\$482.71	\$493.68	\$504.65	\$515.62	\$526.59	\$537.57	\$548.54	\$570.48	\$592.42	\$614.36	\$636.30	\$658.24
17	431.29	442.94	454.60	466.26	477.91	489.57	501.23	512.88	524.54	536.19	547.85	559.51	571.16	582.82	606.13	629.44	652.76	676.07	699.38
18	456.66	469.00	481.34	493.68	506.03	518.37	530.71	543.05	555.39	567.73	580.08	592.42	604.76	617.10	641.79	666.47	691.15	715.84	740.52
19	482.03	495.05	508.08	521.11	534.14	547.16	560.19	573.22	586.25	599.28	612.30	625.33	638.36	651.39	677.44	703.50	729.55	755.61	781.66
20	507.40	521.11	534.82	548.54	562.25	575.96	589.68	603.39	617.10	630.82	644.53	658.24	671.96	685.67	713.10	740.52	767.95	795.38	822.80
21	532.77	547.16	561.56	575.96	590.36	604.76	619.16	633.56	647.96	662.36	676.76	691.15	705.55	719.95	748.75	777.55	806.35	835.14	863.94
22	558.14	573.22	588.30	603.39	618.47	633.56	648.64	663.73	678.81	693.90	708.98	724.07	739.15	754.24	784.40	814.57	844.74	874.91	905.08
23	583.51	599.28	615.05	630.82	646.59	662.36	678.13	693.90	709.67	725.44	741.21	756.98	772.75	788.52	820.06	851.60	883.14	914.68	946.22
24	608.87	625.33	641.79	658.24	674.70	691.15	707.61	724.07	740.52	756.98	773.43	789.89	806.35	822.80	855.71	888.63	921.54	954.45	987.36
25	634.24	651.39	668.53	685.67	702.81	719.95	737.09	754.24	771.38	788.52	805.66	822.80	839.94	857.09	891.37	925.65	959.93	994.22	1,028.50
26	659.61	677.44	695.27	713.10	730.92	748.75	766.58	784.40	802.23	820.06	837.89	855.71	873.54	891.37	927.02	962.68	998.33	1,033.99	1,069.64
27	684.98	703.50	722.01	740.52	759.04	777.55	796.06	814.57	833.09	851.60	870.11	888.63	907.14	925.65	962.68	999.70	1,036.73	1,073.75	1,110.78
28	710.35	729.55	748.75	767.95	787.15	806.35	825.54	844.74	863.94	883.14	902.34	921.54	940.74	959.93	998.33	1,036.73	1,075.13	1,113.52	1,151.92
29	735.72	755.61	775.49	795.38	815.26	835.14	855.03	874.91	894.80	914.68	934.57	954.45	974.33	994.22	1,033.99	1,073.75	1,113.52	1,153.29	1,193.06
30*	761.09	781.66	802.23	822.80	843.37	863.94	884.51	905.08	925.65	946.22	966.79	987.36	1,007.93	1,028.50	1,069.64	1,110.78	1,151.92	1,193.06	1,234.20
31*	786.46	807.72	828.97	850.23	871.48	892.74	914.00	935.25	956.51	977.76	999.02	1,020.27	1,041.53	1,062.78	1,105.30	1,147.81	1,190.32	1,232.83	1,275.34
32*	811.83	833.77	855.71	877.65	899.60	921.54	943.48	965.42	987.36	1,009.30	1,031.24	1,053.18	1,075.13	1,097.07	1,140.95	1,184.83	1,228.71	1,272.60	1,316.48
33*	837.20	859.83	882.45	905.08	927.71	950.34	972.96	995.59	1,018.22	1,040.84	1,063.47	1,086.10	1,108.72	1,131.35	1,176.60	1,221.86	1,267.11	1,312.37	1,357.62
34*	862.57	885.88	909.20	932.51	955.82	979.13	1,002.45	1,025.76	1,049.07	1,072.38	1,095.70	1,119.01	1,142.32	1,165.63	1,212.26	1,258.88	1,305.51	1,352.13	1,398.76
35*	887.94	911.94	935.94	959.93	983.93	1,007.93	1,031.93	1,055.93	1,079.93	1,103.92	1,127.92	1,151.92	1,175.92	1,199.92	1,247.91	1,295.91	1,343.91	1,391.90	1,439.90
36*	913.31	937.99	962.68	987.36	1,012.05	1,036.73	1,061.41	1,086.10	1,110.78	1,135.46	1,160.15	1,184.83	1,209.52	1,234.20	1,283.57	1,332.94	1,382.30	1,431.67	1,481.04
38*	964.05	990.10	1,016.16	1,042.21	1,068.27	1,094.32	1,120.38	1,146.44	1,172.49	1,198.55	1,224.60	1,250.66	1,276.71	1,302.77	1,354.88	1,406.99	1,511.21	1,511.21	1,563.32
40*	1,014.79	1,042.21	1,069.64	1,097.07	1,124.49	1,151.92	1,179.35	1,206.77	1,234.20	1,261.63	1,289.05	1,316.48	1,343.91	1,371.33	1,426.19	1,481.04	1,590.75	1,590.75	1,645.60
42*	1,065.53	1,094.32	1,123.12	1,151.92	1,180.72	1,209.52	1,238.31	1,267.11	1,295.91	1,324.71	1,353.51	1,382.30	1,411.10	1,439.90	1,497.50	1,555.09	1,670.28	1,670.28	1,727.88
44*	1,116.27	1,146.44	1,176.60	1,206.77	1,236.94	1,267.11	1,297.28	1,327.45	1,357.62	1,387.79	1,417.96	1,448.13	1,478.30	1,508.47	1,568.80	1,629.14	1,749.82	1,749.82	1,810.16
46*	1,167.01	1,198.55	1,230.09	1,261.63	1,293.17	1,324.71	1,356.25	1,387.79	1,419.33	1,450.87	1,482.41	1,513.95	1,545.49	1,577.03	1,640.11	1,703.19	1,829.36	1,829.36	1,892.44
48*	1,217.74	1,250.66	1,283.57	1,316.48	1,349.39	1,382.30	1,415.22	1,448.13	1,481.04	1,513.95	1,546.86	1,579.77	1,612.69	1,645.60	1,711.42	1,777.25	1,908.89	1,908.89	1,974.72
50*	1,268.48	1,302.77	1,337.05	1,371.33	1,405.62	1,439.90	1,474.18	1,508.47	1,542.75	1,577.03	1,611.32	1,645.60	1,679.88	1,714.17	1,782.73	1,851.30	1,988.43	1,988.43	2,057.00
52*	1,319.22	1,354.88	1,390.53	1,426.19	1,461.84	1,497.50	1,533.15	1,568.80	1,604.46	1,640.11	1,675.77	1,711.42	1,747.08	1,782.73	1,854.04	1,925.35	2,067.97	2,067.97	2,139.28
54*	1,369.96	1,406.99	1,444.01	1,481.04	1,518.07	1,555.09	1,592.12	1,629.14	1,666.17	1,703.19	1,740.22	1,777.25	1,814.27	1,851.30	1,925.35	1,999.40	2,147.50	2,147.50	2,221.56
56*	1,420.70	1,459.10	1,497.50	1,535.89	1,574.29	1,612.69	1,651.08	1,689.48	1,727.88	1,766.28	1,804.67	1,843.07	1,881.47	1,919.86	1,996.66	2,073.45	2,227.04	2,227.04	2,303.84
58*	1,471.44	1,511.21	1,550.98	1,590.75	1,630.51	1,670.28	1,710.05	1,749.82	1,789.59	1,829.36	1,869.13	1,908.89	1,948.66	1,988.43	2,067.97	2,147.50	2,306.58	2,306.58	2,386.12
60*	1,522.18	1,563.32	1,604.46	1,645.60	1,686.74	1,727.88	1,769.02	1,810.16	1,851.30	1,892.44	1,933.58	1,974.72	2,015.86	2,057.00	2,139.28	2,221.56	2,386.12	2,386.12	2,468.40
61+	<b>EMAIL FOR QUOTE</b>																		

\*Oversize charges will apply

## PRICE AS LISTED



Brushed

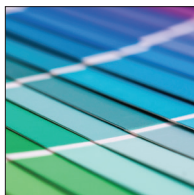

Painted

## OPTIONAL ANODIZED FINISHES - EMAIL FOR QUOTE



Clear



Champagne



Gold



Black



Light Bronze

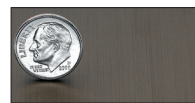

Medium Bronze



Dark Bronze



# Your Logo 1-1/2" Deep Aluminum without Back

**PRICE PER LOGO.** Including standard mounting with pattern.

*Logos smaller than 10" x 10" or with more than 3 pieces email for quote*

Size	16"	17"	18"	19"	20"	21"	22"	23"	24"	25"	26**	27"	28"*	29"	30"*	31"	32**	33"	34"*	35"	36"*
16"	\$176.69	\$187.74	\$198.78	\$209.82	\$220.87	\$231.91	\$242.95	\$254.00	\$265.04	\$276.08	\$287.13	\$298.17	\$309.21	\$320.26	\$331.30	\$342.34	\$353.38	\$364.43	\$375.47	\$386.51	\$397.56
17	187.74	199.47	211.20	222.94	234.67	246.40	258.14	269.87	281.60	293.34	305.07	316.80	328.54	340.27	352.00	363.74	375.47	387.20	398.94	410.67	422.40
18	198.78	211.20	223.63	236.05	248.48	260.90	273.32	285.75	298.17	310.59	323.02	335.44	347.86	360.29	372.71	385.13	397.56	409.98	422.40	434.83	447.25
19	209.82	222.94	236.05	249.17	262.28	275.39	288.51	301.62	314.73	327.85	340.96	354.08	367.19	380.30	393.42	406.53	419.64	432.76	445.87	458.98	472.10
20	220.87	234.67	248.48	262.28	276.08	289.89	303.69	317.49	331.30	345.10	358.91	372.71	386.51	400.32	414.12	427.93	441.73	455.53	469.34	483.14	496.95
21	231.91	246.40	260.90	275.39	289.89	304.38	318.88	333.37	347.86	362.36	376.85	391.35	405.84	420.33	434.83	449.32	463.82	478.31	492.80	507.30	521.79
22	242.95	258.14	273.32	288.51	303.69	318.88	334.06	349.24	364.43	379.61	394.80	409.98	425.17	440.35	455.53	470.72	485.90	501.09	516.27	531.46	546.64
23	254.00	269.87	285.75	301.62	317.49	333.37	349.24	365.12	380.99	396.87	412.74	428.62	444.49	460.37	476.24	492.11	507.99	523.86	539.74	555.61	571.49
24	265.04	281.60	298.17	314.73	331.30	347.86	364.43	380.99	397.56	414.12	430.69	447.25	463.82	480.38	496.95	513.51	530.07	546.64	563.20	579.77	596.33
25	276.08	293.34	310.59	327.85	345.10	362.36	379.61	396.87	414.12	431.38	448.63	465.89	483.14	500.40	517.65	534.91	552.16	569.42	586.67	603.93	621.18
26	287.13	305.07	323.02	340.96	358.91	376.85	394.80	412.74	430.69	448.63	466.58	484.52	502.47	520.41	538.36	556.30	574.25	592.19	610.14	628.08	646.03
27	298.17	316.80	335.44	354.08	372.71	391.35	409.98	428.62	447.25	465.89	484.52	503.16	521.79	540.43	559.06	577.70	596.33	614.97	633.60	652.24	670.87
28	309.21	328.54	347.86	367.19	386.51	405.84	425.17	444.49	463.82	483.14	502.47	521.79	541.12	560.44	579.77	599.09	618.42	637.75	657.07	676.40	695.72
29	320.26	340.27	360.29	380.30	400.32	420.33	440.35	460.37	480.38	500.40	520.41	540.43	560.44	580.46	600.47	620.49	640.51	660.52	680.54	700.55	720.57
30*	331.30	352.00	372.71	393.42	414.12	434.83	455.53	476.24	496.95	517.65	538.36	559.06	579.77	600.47	621.18	641.89	662.59	683.30	704.00	724.71	745.42
31*	342.34	363.74	385.13	406.53	427.93	449.32	470.72	492.11	513.51	534.91	556.30	577.70	599.09	620.49	641.89	663.28	684.68	706.07	727.47	748.87	770.26
32*	353.38	375.47	397.56	419.64	441.73	463.82	485.90	507.99	530.07	552.16	574.25	596.33	618.42	640.51	662.59	684.68	706.76	728.85	750.94	773.02	795.11
33*	364.43	387.20	409.98	432.76	455.53	478.31	501.09	523.86	546.64	569.42	592.19	614.97	637.75	660.52	683.30	706.07	728.85	751.63	774.40	797.18	819.96
34*	375.47	398.94	422.40	445.87	469.34	492.80	516.27	539.74	563.20	586.67	610.14	633.60	657.07	680.54	704.00	727.47	750.94	774.40	797.87	821.34	844.80
35*	386.51	410.67	434.83	458.98	483.14	507.30	531.46	555.61	579.77	603.93	628.08	652.24	676.40	700.55	724.71	748.87	773.02	797.18	821.34	845.49	869.65
36*	397.56	422.40	447.25	472.10	496.95	521.79	546.64	571.49	596.33	621.18	646.03	670.87	695.72	720.57	745.42	770.26	795.11	819.96	844.80	869.65	894.50
38*	419.64	445.87	472.10	498.33	524.55	550.78	577.01	603.24	629.46	655.69	681.92	708.15	734.37	760.60	786.83	813.06	839.28	865.51	891.74	917.96	944.19
40*	441.73	469.34	496.95	524.55	552.16	579.77	607.38	634.98	662.59	690.20	717.81	745.42	773.02	800.63	828.24	855.85	883.45	911.06	938.67	966.28	993.89
42*	463.82	492.80	521.79	550.78	579.77	608.76	637.75	666.73	695.72	724.71	753.70	782.69	811.67	840.66	869.65	898.64	927.63	956.62	985.60	1,014.59	1,043.58
44*	485.90	516.27	546.64	577.01	607.38	637.75	668.11	698.48	728.85	759.22	789.59	819.96	850.33	880.69	911.06	941.43	971.80	1,002.17	1,032.54	1,062.91	1,093.27
46*	507.99	539.74	571.49	603.24	634.98	666.73	698.48	730.23	761.98	793.73	825.48	857.23	888.98	920.73	952.47	984.22	1,015.97	1,047.72	1,079.47	1,111.22	1,142.97
48*	530.07	563.20	596.33	629.46	662.59	695.72	728.85	761.98	795.11	828.24	861.37	894.50	927.63	960.76	993.89	1,027.02	1,060.14	1,093.27	1,126.40	1,159.53	1,192.66
50*	552.16	586.67	621.18	655.69	690.20	724.71	759.22	793.73	828.24	862.75	897.26	931.77	966.28	1,000.79	1,035.30	1,069.81	1,104.32	1,138.83	1,173.34	1,207.85	1,242.36
52*	574.25	610.14	646.03	681.92	717.81	753.70	789.59	825.48	861.37	897.26	933.15	969.04	1,004.93	1,040.82	1,076.71	1,112.60	1,148.49	1,184.38	1,220.27	1,256.16	1,292.05
54*	596.33	633.60	670.87	708.15	745.42	782.69	819.96	857.23	894.50	931.77	969.04	1,006.31	1,043.58	1,080.85	1,118.12	1,155.39	1,192.66	1,229.93	1,267.20	1,304.47	1,341.74
56*	618.42	657.07	695.72	734.37	773.02	811.67	850.33	888.98	927.63	966.28	1,004.93	1,043.58	1,082.23	1,120.88	1,159.53	1,198.18	1,236.83	1,275.49	1,314.14	1,352.79	1,391.44
58*	640.51	680.54	720.57	760.60	800.63	840.66	880.69	920.73	960.76	1,000.79	1,040.82	1,080.85	1,120.88	1,160.91	1,200.94	1,240.98	1,281.01	1,321.04	1,361.07	1,401.10	1,441.13
60*	662.59	704.00	745.42	786.83	828.24	869.65	911.06	952.47	993.89	1,035.30	1,076.71	1,118.12	1,159.53	1,200.94	1,242.36	1,283.77	1,325.18	1,366.59	1,408.00	1,449.42	1,490.83
61+	EMAIL FOR QUOTE																				

\*Oversize charges will apply

## PRICE AS LISTED



Brushed

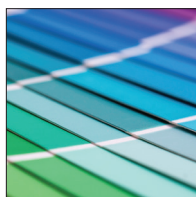

Painted

## OPTIONAL ANODIZED FINISHES - EMAIL FOR QUOTE



Clear

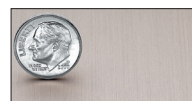

Champagne



Gold



Black



Light Bronze



Medium Bronze



Dark Bronze

# Your Logo 1-1/2" Deep Aluminum without Back

**PRICE PER LOGO.** Including standard mounting with pattern.

*Logos smaller than 10" x 10" or with more than 3 pieces email for quote*

Size	37"*	38"*	39"*	40"*	41"*	42"*	43"*	44"*	45"*	46"*	47"*	48"	49"*	50"	52"*	54"	56"*	58"	60"*
16"	\$408.60	\$419.64	\$430.69	\$441.73	\$452.77	\$463.82	\$474.86	\$485.90	\$496.95	\$507.99	\$519.03	\$530.07	\$541.12	\$552.16	\$574.25	\$596.33	\$618.42	\$640.51	\$662.59
17	434.14	445.87	457.60	469.34	481.07	492.80	504.54	516.27	528.00	539.74	551.47	563.20	574.94	586.67	610.14	633.60	657.07	680.54	704.00
18	459.68	472.10	484.52	496.95	509.37	521.79	534.22	546.64	559.06	571.49	583.91	596.33	608.76	621.18	646.03	670.87	695.72	720.57	745.42
19	485.21	498.33	511.44	524.55	537.67	550.78	563.89	577.01	590.12	603.24	616.35	629.46	642.58	655.69	681.92	708.15	734.37	760.60	786.83
20	510.75	524.55	538.36	552.16	565.97	579.77	593.57	607.38	621.18	634.98	648.79	662.59	676.40	690.20	717.81	745.42	773.02	800.63	828.24
21	536.29	550.78	565.27	579.77	594.26	608.76	623.25	637.75	652.24	666.73	681.23	695.72	710.22	724.71	753.70	782.69	811.67	840.66	869.65
22	561.82	577.01	592.19	607.38	622.56	637.75	652.93	668.11	683.30	698.48	713.67	728.85	744.04	759.22	789.59	819.96	850.33	880.69	911.06
23	587.36	603.24	619.11	634.98	650.86	666.73	682.61	698.48	714.36	730.23	746.11	761.98	777.86	793.73	825.48	857.23	888.98	920.73	952.47
24	612.90	629.46	646.03	662.59	679.16	695.72	712.29	728.85	745.42	761.98	778.55	795.11	811.67	828.24	861.37	894.50	927.63	960.76	993.89
25	638.44	655.69	672.95	690.20	707.46	724.71	741.96	759.22	776.47	793.73	810.98	828.24	845.49	862.75	897.26	931.77	966.28	1,000.79	1,035.30
26	663.97	681.92	699.86	717.81	735.75	753.70	771.64	789.59	807.53	825.48	843.42	861.37	879.31	897.26	933.15	969.04	1,004.93	1,040.82	1,076.71
27	689.51	708.15	726.78	745.42	764.05	782.69	801.32	819.96	838.59	857.23	875.86	894.50	913.13	931.77	969.04	1,006.31	1,043.58	1,080.85	1,118.12
28	715.05	734.37	753.70	773.02	792.35	811.67	831.00	850.33	869.65	888.98	908.30	927.63	946.95	966.28	1,004.93	1,043.58	1,082.23	1,120.88	1,159.53
29	740.58	760.60	780.62	800.63	820.65	840.66	860.68	880.69	900.71	920.73	940.74	960.76	980.77	1,000.79	1,040.82	1,080.85	1,120.88	1,160.91	1,200.94
30*	766.12	786.83	807.53	828.24	848.95	869.65	890.36	911.06	931.77	952.47	973.18	993.89	1,014.59	1,035.30	1,076.71	1,118.12	1,159.53	1,200.94	1,242.36
31*	791.66	813.06	834.45	855.85	877.24	898.64	920.04	941.43	962.83	984.22	1,005.62	1,027.02	1,048.41	1,069.81	1,112.60	1,155.39	1,198.18	1,240.98	1,283.77
32*	817.20	839.28	861.37	883.45	905.54	927.63	949.71	971.80	993.89	1,015.97	1,038.06	1,060.14	1,082.23	1,104.32	1,148.49	1,192.66	1,236.83	1,281.01	1,325.18
33*	842.73	865.51	888.29	911.06	933.84	956.62	979.39	1,002.17	1,024.95	1,047.72	1,070.50	1,093.27	1,116.05	1,138.83	1,184.38	1,229.93	1,275.49	1,321.04	1,366.59
34*	868.27	891.74	915.20	938.67	962.14	985.60	1,009.07	1,032.54	1,056.00	1,079.47	1,102.94	1,126.40	1,149.87	1,173.34	1,220.27	1,267.20	1,314.14	1,361.07	1,408.00
35*	893.81	917.96	942.12	966.28	990.44	1,014.59	1,038.75	1,062.91	1,087.06	1,111.22	1,135.38	1,159.53	1,183.69	1,207.85	1,256.16	1,304.47	1,352.79	1,401.10	1,449.42
36*	919.35	944.19	969.04	993.89	1,018.73	1,043.58	1,068.43	1,093.27	1,118.12	1,142.97	1,167.82	1,192.66	1,217.51	1,242.36	1,292.05	1,341.74	1,391.44	1,441.13	1,490.83
38*	970.42	996.65	1,022.87	1,049.10	1,075.33	1,101.56	1,127.78	1,154.01	1,180.24	1,206.47	1,232.69	1,258.92	1,285.15	1,311.38	1,363.83	1,416.29	1,468.74	1,521.20	1,573.65
40*	1,021.49	1,049.10	1,076.71	1,104.32	1,131.93	1,159.53	1,187.14	1,214.75	1,242.36	1,269.96	1,297.57	1,325.18	1,352.79	1,380.40	1,435.61	1,490.83	1,546.04	1,601.26	1,656.47
42*	1,072.57	1,101.56	1,130.54	1,159.53	1,188.52	1,217.51	1,246.50	1,275.49	1,304.47	1,333.46	1,362.45	1,391.44	1,420.43	1,449.42	1,507.39	1,565.37	1,623.34	1,681.32	1,739.30
44*	1,123.64	1,154.01	1,184.38	1,214.75	1,245.12	1,275.49	1,305.85	1,336.22	1,366.59	1,396.96	1,427.33	1,457.70	1,488.07	1,518.43	1,579.17	1,639.91	1,700.65	1,761.38	1,822.12
46*	1,174.72	1,206.47	1,238.22	1,269.96	1,301.71	1,333.46	1,365.21	1,396.96	1,428.71	1,460.46	1,492.21	1,523.96	1,555.71	1,587.45	1,650.95	1,714.45	1,777.95	1,841.45	1,904.94
48*	1,225.79	1,258.92	1,292.05	1,325.18	1,358.31	1,391.44	1,424.57	1,457.70	1,490.83	1,523.96	1,557.09	1,590.21	1,623.34	1,656.47	1,722.73	1,788.99	1,855.25	1,921.51	1,987.77
50*	1,276.87	1,311.38	1,345.89	1,380.40	1,414.91	1,449.42	1,483.92	1,518.43	1,552.94	1,587.45	1,621.96	1,656.47	1,690.98	1,725.49	1,794.51	1,863.53	1,932.55	2,001.57	2,070.59
52*	1,327.94	1,363.83	1,399.72	1,435.61	1,471.50	1,507.39	1,543.28	1,579.17	1,615.06	1,650.95	1,686.84	1,722.73	1,758.62	1,794.51	1,866.29	1,938.07	2,009.85	2,081.63	2,153.41
54*	1,379.02	1,416.29	1,453.56	1,490.83	1,528.10	1,565.37	1,602.64	1,639.91	1,677.18	1,714.45	1,751.72	1,788.99	1,826.26	1,863.53	1,938.07	2,012.61	2,087.16	2,161.70	2,236.24
56*	1,430.09	1,468.74	1,507.39	1,546.04	1,584.69	1,623.34	1,662.00	1,700.65	1,739.30	1,777.95	1,816.60	1,855.25	1,893.90	1,932.55	2,009.85	2,087.16	2,164.46	2,241.76	2,319.06
58*	1,481.16	1,521.20	1,561.23	1,601.26	1,641.29	1,681.32	1,721.35	1,761.38	1,801.41	1,841.45	1,881.48	1,921.51	1,961.54	2,001.57	2,081.63	2,161.70	2,241.76	2,321.82	2,401.88
60*	1,532.24	1,573.65	1,615.06	1,656.47	1,697.89	1,739.30	1,780.71	1,822.12	1,863.53	1,904.94	1,946.36	1,987.77	2,029.18	2,070.59	2,153.41	2,236.24	2,319.06	2,401.88	2,484.71
61+	<b>EMAIL FOR QUOTE</b>																		

\*Oversize charges will apply

### PRICE AS LISTED



Brushed

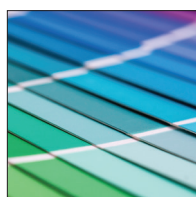

Painted

### OPTIONAL ANODIZED FINISHES - EMAIL FOR QUOTE



Clear

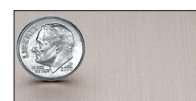

Champagne

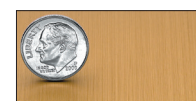

Gold

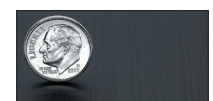

Black



Light Bronze

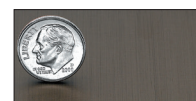

Medium Bronze



Dark Bronze

# Your Logo 1-1/2" Deep Aluminum with Back

**PRICE PER LOGO.** Including standard mounting with pattern.

*Logos smaller than 10" x 10" or with more than 3 pieces email for quote*

Size	16"	17"	18"	19"	20"	21"	22"	23"	24"	25"	26**	27"	28**	29"	30**	31"	32**	33"	34**	35"	36**
16"	\$201.86	\$214.48	\$227.10	\$239.71	\$252.33	\$264.95	\$277.56	\$290.18	\$302.79	\$315.41	\$328.03	\$340.64	\$353.26	\$365.88	\$378.49	\$391.11	\$403.72	\$416.34	\$428.96	\$441.57	\$454.19
17	214.48	227.89	241.29	254.70	268.10	281.51	294.91	308.31	321.72	335.12	348.53	361.93	375.34	388.74	402.15	415.55	428.96	442.36	455.77	469.17	482.58
18	227.10	241.29	255.48	269.68	283.87	298.06	312.26	326.45	340.64	354.84	369.03	383.22	397.42	411.61	425.80	440.00	454.19	468.38	482.58	496.77	510.96
19	239.71	254.70	269.68	284.66	299.64	314.62	329.60	344.59	359.57	374.55	389.53	404.51	419.50	434.48	449.46	464.44	479.42	494.40	509.39	524.37	539.35
20	252.33	268.10	283.87	299.64	315.41	331.18	346.95	362.72	378.49	394.26	410.03	425.80	441.57	457.34	473.11	488.88	504.65	520.43	536.20	551.97	567.74
21	264.95	281.51	298.06	314.62	331.18	347.74	364.30	380.86	397.42	413.98	430.53	447.09	463.65	480.21	496.77	513.33	529.89	546.45	563.01	579.56	596.12
22	277.56	294.91	312.26	329.60	346.95	364.30	381.65	398.99	416.34	433.69	451.04	468.38	485.73	503.08	520.43	537.77	555.12	572.47	589.81	607.16	624.51
23	290.18	308.31	326.45	344.59	362.72	380.86	398.99	417.13	435.27	453.40	471.54	489.67	507.81	525.94	544.08	562.22	580.35	598.49	616.62	634.76	652.90
24	302.79	321.72	340.64	359.57	378.49	397.42	416.34	435.27	454.19	473.11	492.04	510.96	529.89	548.81	567.74	586.66	605.58	624.51	643.43	662.36	681.28
25	315.41	335.12	354.84	374.55	394.26	413.98	433.69	453.40	473.11	492.83	512.54	532.25	551.97	571.68	591.39	611.10	630.82	650.53	670.24	689.96	709.67
26	328.03	348.53	369.03	389.53	410.03	430.53	451.04	471.54	492.04	512.54	533.04	553.54	574.04	594.55	615.05	635.55	656.05	676.55	697.05	717.55	738.06
27	340.64	361.93	383.22	404.51	425.80	447.09	468.38	489.67	510.96	532.25	553.54	574.83	596.12	617.41	638.70	659.99	681.28	702.57	723.86	745.15	766.44
28	353.26	375.34	397.42	419.50	441.57	463.65	485.73	507.81	529.89	551.97	574.04	596.12	618.20	640.28	662.36	684.44	706.51	728.59	750.67	772.75	794.83
29	365.88	388.74	411.61	434.48	457.34	480.21	503.08	525.94	548.81	571.68	594.55	617.41	640.28	663.15	686.01	708.88	731.75	754.61	777.48	800.35	823.22
30*	378.49	402.15	425.80	449.46	473.11	496.77	520.43	544.08	567.74	591.39	615.05	638.70	662.36	686.01	709.67	733.32	756.98	780.64	804.29	827.95	851.60
31*	391.11	415.55	440.00	464.44	488.88	513.33	537.77	562.22	586.66	611.10	635.55	659.99	684.44	708.88	733.32	757.77	782.21	806.66	831.10	855.54	879.99
32*	403.72	428.96	454.19	479.42	504.65	529.89	555.12	580.35	605.58	630.82	656.05	681.28	706.51	731.75	756.98	782.21	807.44	832.68	857.91	883.14	908.37
33*	416.34	442.36	468.38	494.40	520.43	546.45	572.47	598.49	624.51	650.53	676.55	702.57	728.59	754.61	780.64	806.66	832.68	858.70	884.72	910.74	936.76
34*	428.96	455.77	482.58	509.39	536.20	563.01	589.81	616.62	643.43	670.24	697.05	723.86	750.67	777.48	804.29	831.10	857.91	884.72	911.53	938.34	965.15
35*	441.57	469.17	496.77	524.37	551.97	579.56	607.16	634.76	662.36	689.96	717.55	745.15	772.75	800.35	827.95	855.54	883.14	910.74	938.34	965.94	993.53
36*	454.19	482.58	510.96	539.35	567.74	596.12	624.51	652.90	681.28	709.67	738.06	766.44	794.83	823.22	851.60	879.99	908.37	936.76	965.15	993.53	1,021.92
38*	479.42	509.39	539.35	569.31	599.28	629.24	659.20	689.17	719.13	749.09	779.06	809.02	838.99	868.95	898.91	928.88	958.84	988.80	1,018.77	1,048.73	1,078.69
40*	504.65	536.20	567.74	599.28	630.82	662.36	693.90	725.44	756.98	788.52	820.06	851.60	883.14	914.68	946.22	977.76	1,009.30	1,040.85	1,072.39	1,103.93	1,135.47
42*	529.89	563.01	596.12	629.24	662.36	695.48	728.59	761.71	794.83	827.95	861.06	894.18	927.30	960.42	993.53	1,026.65	1,059.77	1,092.89	1,126.01	1,159.12	1,192.24
44*	555.12	589.81	624.51	659.20	693.90	728.59	763.29	797.98	832.68	867.37	902.07	936.76	971.46	1,006.15	1,040.85	1,075.54	1,110.23	1,144.93	1,179.62	1,214.32	1,249.01
46*	580.35	616.62	652.90	689.17	725.44	761.71	797.98	834.25	870.53	906.80	943.07	979.34	1,015.61	1,051.88	1,088.16	1,124.43	1,160.70	1,196.97	1,233.24	1,269.52	1,305.79
48*	605.58	643.43	681.28	719.13	756.98	794.83	832.68	870.53	908.37	946.22	984.07	1,021.92	1,059.77	1,097.62	1,135.47	1,173.32	1,211.16	1,249.01	1,286.86	1,324.71	1,362.56
50*	630.82	670.24	709.67	749.09	788.52	827.95	867.37	906.80	946.22	985.65	1,025.08	1,064.50	1,103.93	1,143.35	1,182.78	1,222.20	1,261.63	1,301.06	1,340.48	1,379.91	1,419.33
52*	656.05	697.05	738.06	779.06	820.06	861.06	902.07	943.07	984.07	1,025.08	1,066.08	1,107.08	1,148.08	1,189.09	1,230.09	1,271.09	1,312.09	1,353.10	1,394.10	1,435.10	1,476.11
54*	681.28	723.86	766.44	809.02	851.60	894.18	936.76	979.34	1,021.92	1,064.50	1,107.08	1,149.66	1,192.24	1,234.82	1,277.40	1,319.98	1,362.56	1,405.14	1,447.72	1,490.30	1,532.88
56*	706.51	750.67	794.83	838.99	883.14	927.30	971.46	1,015.61	1,059.77	1,103.93	1,148.08	1,192.24	1,236.40	1,280.55	1,324.71	1,368.87	1,413.02	1,457.18	1,501.34	1,545.50	1,589.65
58*	731.75	777.48	823.22	868.95	914.68	960.42	1,006.15	1,051.88	1,097.62	1,143.35	1,189.09	1,234.82	1,280.55	1,326.29	1,372.02	1,417.76	1,463.49	1,509.22	1,554.96	1,600.69	1,646.43
60*	756.98	804.29	851.60	898.91	946.22	993.53	1,040.85	1,088.16	1,135.47	1,182.78	1,230.09	1,277.40	1,324.71	1,372.02	1,419.33	1,466.64	1,513.95	1,561.27	1,608.58	1,655.89	1,703.20
61+	<b>EMAIL FOR QUOTE</b>																				

\*Oversize charges will apply

## PRICE AS LISTED



Brushed

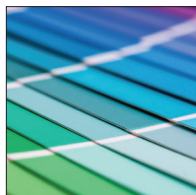

Painted

## OPTIONAL ANODIZED FINISHES - EMAIL FOR QUOTE



Clear



Champagne



Gold



Black



Light Bronze



Medium Bronze



Dark Bronze



## Your Logo 1-1/2" Deep Aluminum with Back

**PRICE PER LOGO.** Including standard mounting with pattern.

*Logos smaller than 10" x 10" or with more than 3 pieces email for quote*

Size	37"*	38"*	39"*	40"*	41"*	42"*	43"*	44"*	45"*	46"*	47"*	48"	49"*	50"	52"*	54"	56"*	58"	60"*
16"	\$466.81	\$479.42	\$492.04	\$504.65	\$517.27	\$529.89	\$542.50	\$555.12	\$567.74	\$580.35	\$592.97	\$605.58	\$618.20	\$630.82	\$656.05	\$681.28	\$706.51	\$731.75	\$756.98
17	495.98	509.39	522.79	536.20	549.60	563.01	576.41	589.81	603.22	616.62	630.03	643.43	656.84	670.24	697.05	723.86	750.67	777.48	804.29
18	525.16	539.35	553.54	567.74	581.93	596.12	610.32	624.51	638.70	652.90	667.09	681.28	695.48	709.67	738.06	766.44	794.83	823.22	851.60
19	554.33	569.31	584.30	599.28	614.26	629.24	644.22	659.20	674.19	689.17	704.15	719.13	734.11	749.09	779.06	809.02	838.99	868.95	898.91
20	583.51	599.28	615.05	630.82	646.59	662.36	678.13	693.90	709.67	725.44	741.21	756.98	772.75	788.52	820.06	851.60	883.14	914.68	946.22
21	612.68	629.24	645.80	662.36	678.92	695.48	712.03	728.59	745.15	761.71	778.27	794.83	811.39	827.95	861.06	894.18	927.30	960.42	993.53
22	641.86	659.20	676.55	693.90	711.25	728.59	745.94	763.29	780.64	797.98	815.33	832.68	850.02	867.37	902.07	936.76	971.46	1,006.15	1,040.85
23	671.03	689.17	707.30	725.44	743.58	761.71	779.85	797.98	816.12	834.25	852.39	870.53	888.66	906.80	943.07	979.34	1,015.61	1,051.88	1,088.16
24	700.21	719.13	738.06	756.98	775.90	794.83	813.75	832.68	851.60	870.53	889.45	908.37	927.30	946.22	984.07	1,021.92	1,059.77	1,097.62	1,135.47
25	729.38	749.09	768.81	788.52	808.23	827.95	847.66	867.37	887.09	906.80	926.51	946.22	965.94	985.65	1,025.08	1,064.50	1,103.93	1,143.35	1,182.78
26	758.56	779.06	799.56	820.06	840.56	861.06	881.57	902.07	922.57	943.07	963.57	984.07	1,004.57	1,025.08	1,066.08	1,107.08	1,148.08	1,189.09	1,230.09
27	787.73	809.02	830.31	851.60	872.89	894.18	915.47	936.76	958.05	979.34	1,000.63	1,021.92	1,043.21	1,064.50	1,107.08	1,149.66	1,192.24	1,234.82	1,277.40
28	816.91	838.99	861.06	883.14	905.22	927.30	949.38	971.46	993.53	1,015.61	1,037.69	1,059.77	1,081.85	1,103.93	1,148.08	1,192.24	1,236.40	1,280.55	1,324.71
29	846.08	868.95	891.82	914.68	937.55	960.42	983.28	1,006.15	1,029.02	1,051.88	1,074.75	1,097.62	1,120.49	1,143.35	1,189.09	1,234.82	1,280.55	1,326.29	1,372.02
30*	875.26	898.91	922.57	946.22	969.88	993.53	1,017.19	1,040.85	1,064.50	1,088.16	1,111.81	1,135.47	1,159.12	1,182.78	1,230.09	1,277.40	1,324.71	1,372.02	1,419.33
31*	904.43	928.88	953.32	977.76	1,002.21	1,026.65	1,051.10	1,075.54	1,099.98	1,124.43	1,148.87	1,173.32	1,197.76	1,222.20	1,271.09	1,319.98	1,368.87	1,417.76	1,466.64
32*	933.61	958.84	984.07	1,009.30	1,034.54	1,059.77	1,085.00	1,110.23	1,135.47	1,160.70	1,185.93	1,211.16	1,236.40	1,261.63	1,312.09	1,362.56	1,413.02	1,463.49	1,513.95
33*	962.78	988.80	1,014.82	1,040.85	1,066.87	1,092.89	1,118.91	1,144.93	1,170.95	1,196.97	1,222.99	1,249.01	1,275.03	1,301.06	1,353.10	1,405.14	1,457.18	1,509.22	1,561.27
34*	991.96	1,018.77	1,045.58	1,072.39	1,099.20	1,126.01	1,152.81	1,179.62	1,206.43	1,233.24	1,260.05	1,286.86	1,313.67	1,340.48	1,394.10	1,447.72	1,501.34	1,554.96	1,608.58
35*	1,021.13	1,048.73	1,076.33	1,103.93	1,131.52	1,159.12	1,186.72	1,214.32	1,241.92	1,269.52	1,297.11	1,324.71	1,352.31	1,379.91	1,435.10	1,490.30	1,545.50	1,600.69	1,655.89
36*	1,050.31	1,078.69	1,107.08	1,135.47	1,163.85	1,192.24	1,220.63	1,249.01	1,277.40	1,305.79	1,334.17	1,362.56	1,390.95	1,419.33	1,476.11	1,532.88	1,589.65	1,646.43	1,703.20
38*	1,108.66	1,138.62	1,168.59	1,198.55	1,228.51	1,258.48	1,288.44	1,318.40	1,348.37	1,378.33	1,408.29	1,438.26	1,468.22	1,498.18	1,558.11	1,618.04	1,677.97	1,737.89	1,797.82
40*	1,167.01	1,198.55	1,230.09	1,261.63	1,293.17	1,324.71	1,356.25	1,387.79	1,419.33	1,450.87	1,482.41	1,513.95	1,545.50	1,577.04	1,640.12	1,703.20	1,766.28	1,829.36	1,892.44
42*	1,225.36	1,258.48	1,291.59	1,324.71	1,357.83	1,390.95	1,424.06	1,457.18	1,490.30	1,523.42	1,556.53	1,589.65	1,622.77	1,655.89	1,722.12	1,788.36	1,854.59	1,920.83	1,987.06
44*	1,283.71	1,318.40	1,353.10	1,387.79	1,422.49	1,457.18	1,491.88	1,526.57	1,561.27	1,595.96	1,630.66	1,665.35	1,700.04	1,734.74	1,804.13	1,873.52	1,942.91	2,012.30	2,081.69
46*	1,342.06	1,378.33	1,414.60	1,450.87	1,487.15	1,523.42	1,559.69	1,595.96	1,632.23	1,668.50	1,704.78	1,741.05	1,777.32	1,813.59	1,886.13	1,958.68	2,031.22	2,103.76	2,176.31
48*	1,400.41	1,438.26	1,476.11	1,513.95	1,551.80	1,589.65	1,627.50	1,665.35	1,703.20	1,741.05	1,778.90	1,816.74	1,854.59	1,892.44	1,968.14	2,043.84	2,119.53	2,195.23	2,270.93
50*	1,458.76	1,498.18	1,537.61	1,577.04	1,616.46	1,655.89	1,695.31	1,734.74	1,774.17	1,813.59	1,853.02	1,892.44	1,931.87	1,971.29	2,050.15	2,129.00	2,207.85	2,286.70	2,365.55
52*	1,517.11	1,558.11	1,599.11	1,640.12	1,681.12	1,722.12	1,763.13	1,804.13	1,845.13	1,886.13	1,927.14	1,968.14	2,009.14	2,050.15	2,132.15	2,214.16	2,296.16	2,378.17	2,460.17
54*	1,575.46	1,618.04	1,660.62	1,703.20	1,745.78	1,788.36	1,830.94	1,873.52	1,916.10	1,958.68	2,001.26	2,043.84	2,086.42	2,129.00	2,214.16	2,299.32	2,384.48	2,469.64	2,554.80
56*	1,633.81	1,677.97	1,722.12	1,766.28	1,810.44	1,854.59	1,898.75	1,942.91	1,987.06	2,031.22	2,075.38	2,119.53	2,163.69	2,207.85	2,296.16	2,384.48	2,472.79	2,561.10	2,649.42
58*	1,692.16	1,737.89	1,783.63	1,829.36	1,875.10	1,920.83	1,966.56	2,012.30	2,058.03	2,103.76	2,149.50	2,195.23	2,240.97	2,286.70	2,378.17	2,469.64	2,561.10	2,652.57	2,744.04
60*	1,750.51	1,797.82	1,845.13	1,892.44	1,939.75	1,987.06	2,034.38	2,081.69	2,129.00	2,176.31	2,223.62	2,270.93	2,318.24	2,365.55	2,460.17	2,554.80	2,649.42	2,744.04	2,838.66
61+	<b>EMAIL FOR QUOTE</b>																		

\*Oversize charges will apply

### PRICE AS LISTED



Brushed

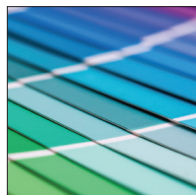

Painted

### OPTIONAL ANODIZED FINISHES - EMAIL FOR QUOTE



Clear



Champagne

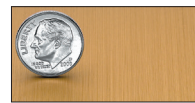

Gold

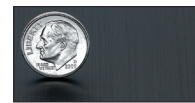

Black



Light Bronze



Medium Bronze



Dark Bronze

# Your Logo 2" Deep Aluminum without Back

**PRICE PER LOGO.** Including standard mounting with pattern.

*Logos smaller than 10" x 10" or with more than 3 pieces email for quote*

Size	16"	17"	18"	19"	20"	21"	22"	23"	24"	25"	26**	27"	28"*	29"	30"*	31"	32**	33"	34"*	35"	36"*
16"	\$184.37	\$195.90	\$207.42	\$218.94	\$230.47	\$241.99	\$253.51	\$265.04	\$276.56	\$288.08	\$299.61	\$311.13	\$322.65	\$334.18	\$345.70	\$357.22	\$368.74	\$380.27	\$391.79	\$403.31	\$414.84
17	195.90	208.14	220.38	232.63	244.87	257.11	269.36	281.60	293.84	306.09	318.33	330.57	342.82	355.06	367.30	379.55	391.79	404.03	416.28	428.52	440.76
18	207.42	220.38	233.35	246.31	259.28	272.24	285.20	298.17	311.13	324.09	337.06	350.02	362.98	375.95	388.91	401.87	414.84	427.80	440.76	453.73	466.69
19	218.94	232.63	246.31	260.00	273.68	287.36	301.05	314.73	328.41	342.10	355.78	369.47	383.15	396.83	410.52	424.20	437.88	451.57	465.25	478.93	492.62
20	230.47	244.87	259.28	273.68	288.08	302.49	316.89	331.29	345.70	360.10	374.51	388.91	403.31	417.72	432.12	446.53	460.93	475.33	489.74	504.14	518.55
21	241.99	257.11	272.24	287.36	302.49	317.61	332.74	347.86	362.98	378.11	393.23	408.36	423.48	438.60	453.73	468.85	483.98	499.10	514.22	529.35	544.47
22	253.51	269.36	285.20	301.05	316.89	332.74	348.58	364.42	380.27	396.11	411.96	427.80	443.65	459.49	475.33	491.18	507.02	522.87	538.71	554.56	570.40
23	265.04	281.60	298.17	314.73	331.29	347.86	364.42	380.99	397.55	414.12	430.68	447.25	463.81	480.38	496.94	513.50	530.07	546.63	563.20	579.76	596.33
24	276.56	293.84	311.13	328.41	345.70	362.98	380.27	397.55	414.84	432.12	449.41	466.69	483.98	501.26	518.55	535.83	553.11	570.40	587.68	604.97	622.25
25	288.08	306.09	324.09	342.10	360.10	378.11	396.11	414.12	432.12	450.13	468.13	486.14	504.14	522.15	540.15	558.16	576.16	594.17	612.17	630.18	648.18
26	299.61	318.33	337.06	355.78	374.51	393.23	411.96	430.68	449.41	468.13	486.86	505.58	524.31	543.03	561.76	580.48	599.21	617.93	636.66	655.38	674.11
27	311.13	330.57	350.02	369.47	388.91	408.36	427.80	447.25	466.69	486.14	505.58	525.03	544.47	563.92	583.36	602.81	622.25	641.70	661.14	680.59	700.03
28	322.65	342.82	362.98	383.15	403.31	423.48	443.65	463.81	483.98	504.14	524.31	544.47	564.64	584.80	604.97	625.13	645.30	665.47	685.63	705.80	725.96
29	334.18	355.06	375.95	396.83	417.72	438.60	459.49	480.38	501.26	522.15	543.03	563.92	584.80	605.69	626.57	647.46	668.35	689.23	710.12	731.00	751.89
30*	345.70	367.30	388.91	410.52	432.12	453.73	475.33	496.94	518.55	540.15	561.76	583.36	604.97	626.57	648.18	669.79	691.39	713.00	734.60	756.21	777.82
31*	357.22	379.55	401.87	424.20	446.53	468.85	491.18	513.50	535.83	558.16	580.48	602.81	625.13	647.46	669.79	692.11	714.44	736.76	759.09	781.42	803.74
32*	368.74	391.79	414.84	437.88	460.93	483.98	507.02	530.07	553.11	576.16	599.21	622.25	645.30	668.35	691.39	714.44	737.48	760.53	783.58	806.62	829.67
33*	380.27	404.03	427.80	451.57	475.33	499.10	522.87	546.63	570.40	594.17	617.93	641.70	665.47	689.23	713.00	736.76	760.53	784.30	808.06	831.83	855.60
34*	391.79	416.28	440.76	465.25	489.74	514.22	538.71	563.20	587.68	612.17	636.66	661.14	685.63	710.12	734.60	759.09	783.58	808.06	832.55	857.04	881.52
35*	403.31	428.52	453.73	478.93	504.14	529.35	554.56	579.76	604.97	630.18	655.38	680.59	705.80	731.00	756.21	781.42	806.62	831.83	857.04	882.24	907.45
36*	414.84	440.76	466.69	492.62	518.55	544.47	570.40	596.33	622.25	648.18	674.11	700.03	725.96	751.89	777.82	803.74	829.67	855.60	881.52	907.45	933.38
38*	437.88	465.25	492.62	519.99	547.35	574.72	602.09	629.46	656.82	684.19	711.56	738.93	766.29	793.66	821.03	848.40	875.76	903.13	930.50	957.86	985.23
40*	460.93	489.74	518.55	547.35	576.16	604.97	633.78	662.58	691.39	720.20	749.01	777.82	806.62	835.43	864.24	893.05	921.85	950.66	979.47	1,008.28	1,037.09
42*	483.98	514.22	544.47	574.72	604.97	635.22	665.47	695.71	725.96	756.21	786.46	816.71	846.95	877.20	907.45	937.70	967.95	998.20	1,028.44	1,058.69	1,088.94
44*	507.02	538.71	570.40	602.09	633.78	665.47	697.15	728.84	760.53	792.22	823.91	855.60	887.29	918.97	950.66	982.35	1,014.04	1,045.73	1,077.42	1,109.11	1,140.79
46*	530.07	563.20	596.33	629.46	662.58	695.71	728.84	761.97	795.10	828.23	861.36	894.49	927.62	960.75	993.87	1,027.00	1,060.13	1,093.26	1,126.39	1,159.52	1,192.65
48*	553.11	587.68	622.25	656.82	691.39	725.96	760.53	795.10	829.67	864.24	898.81	933.38	967.95	1,002.52	1,037.09	1,071.66	1,106.22	1,140.79	1,175.36	1,209.93	1,244.50
50*	576.16	612.17	648.18	684.19	720.20	756.21	792.22	828.23	864.24	900.25	936.26	972.27	1,008.28	1,044.29	1,080.30	1,116.31	1,152.32	1,188.33	1,224.34	1,260.35	1,296.36
52*	599.21	636.66	674.11	711.56	749.01	786.46	823.91	861.36	898.81	936.26	973.71	1,011.16	1,048.61	1,086.06	1,123.51	1,160.96	1,198.41	1,235.86	1,273.31	1,310.76	1,348.21
54*	622.25	661.14	700.03	738.93	777.82	816.71	855.60	894.49	933.38	972.27	1,011.16	1,050.05	1,088.94	1,127.83	1,166.72	1,205.61	1,244.50	1,283.39	1,322.28	1,361.17	1,400.06
56*	645.30	685.63	725.96	766.29	806.62	846.95	887.29	927.62	967.95	1,008.28	1,048.61	1,088.94	1,129.27	1,169.60	1,209.93	1,250.26	1,290.59	1,330.93	1,371.26	1,411.59	1,451.92
58*	668.35	710.12	751.89	793.66	835.43	877.20	918.97	960.75	1,002.52	1,044.29	1,086.06	1,127.83	1,169.60	1,211.37	1,253.14	1,294.92	1,336.69	1,378.46	1,420.23	1,462.00	1,503.77
60*	691.39	734.60	777.82	821.03	864.24	907.45	950.66	993.87	1,037.09	1,080.30	1,123.51	1,166.72	1,209.93	1,253.14	1,296.36	1,339.57	1,382.78	1,425.99	1,469.20	1,512.42	1,555.63
61+	<b>EMAIL FOR QUOTE</b>																				

\*Oversize charges will apply

### PRICE AS LISTED



Brushed

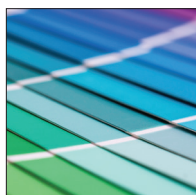

Painted

### OPTIONAL ANODIZED FINISHES - EMAIL FOR QUOTE



Clear



Champagne



Gold

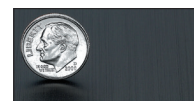

Black



Light Bronze



Medium Bronze



Dark Bronze

# Your Logo 2" Deep Aluminum without Back

**PRICE PER LOGO.** Including standard mounting with pattern.

*Logos smaller than 10" x 10" or with more than 3 pieces email for quote*

Size	37"*	38"*	39"*	40"*	41"*	42"*	43"*	44"*	45"*	46"*	47"*	48"	49"*	50"	52"*	54"	56"*	58"	60"*
16"	\$426.36	\$437.88	\$449.41	\$460.93	\$472.45	\$483.98	\$495.50	\$507.02	\$518.55	\$530.07	\$541.59	\$553.11	\$564.64	\$576.16	\$599.21	\$622.25	\$645.30	\$668.35	\$691.39
17	453.01	465.25	477.49	489.74	501.98	514.22	526.47	538.71	550.95	563.20	575.44	587.68	599.93	612.17	636.66	661.14	685.63	710.12	734.60
18	479.66	492.62	505.58	518.55	531.51	544.47	557.44	570.40	583.36	596.33	609.29	622.25	635.22	648.18	674.11	700.03	725.96	751.89	777.82
19	506.30	519.99	533.67	547.35	561.04	574.72	588.40	602.09	615.77	629.46	643.14	656.82	670.51	684.19	711.56	738.93	766.29	793.66	821.03
20	532.95	547.35	561.76	576.16	590.57	604.97	619.37	633.78	648.18	662.58	676.99	691.39	705.80	720.20	749.01	777.82	806.62	835.43	864.24
21	559.60	574.72	589.84	604.97	620.09	635.22	650.34	665.47	680.59	695.71	710.84	725.96	741.09	756.21	786.46	816.71	846.95	877.20	907.45
22	586.24	602.09	617.93	633.78	649.62	665.47	681.31	697.15	713.00	728.84	744.69	760.53	776.38	792.22	823.91	855.60	887.29	918.97	950.66
23	612.89	629.46	646.02	662.58	679.15	695.71	712.28	728.84	745.41	761.97	778.54	795.10	811.67	828.23	861.36	894.49	927.62	960.75	993.87
24	639.54	656.82	674.11	691.39	708.68	725.96	743.25	760.53	777.82	795.10	812.39	829.67	846.95	864.24	898.81	933.38	967.95	1,002.52	1,037.09
25	666.19	684.19	702.20	720.20	738.21	756.21	774.21	792.22	810.22	828.23	846.23	864.24	882.24	900.25	936.26	972.27	1,008.28	1,044.29	1,080.30
26	692.83	711.56	730.28	749.01	767.73	786.46	805.18	823.91	842.63	861.36	880.08	898.81	917.53	936.26	973.71	1,011.16	1,048.61	1,086.06	1,123.51
27	719.48	738.93	758.37	777.82	797.26	816.71	836.15	855.60	875.04	894.49	913.93	933.38	952.82	972.27	1,011.16	1,050.05	1,088.94	1,127.83	1,166.72
28	746.13	766.29	786.46	806.62	826.79	846.95	867.12	887.29	907.45	927.62	947.78	967.95	988.11	1,008.28	1,048.61	1,088.94	1,129.27	1,169.60	1,209.93
29	772.77	793.66	814.55	835.43	856.32	877.20	898.09	918.97	939.86	960.75	981.63	1,002.52	1,023.40	1,044.29	1,086.06	1,127.83	1,169.60	1,211.37	1,253.14
30*	799.42	821.03	842.63	864.24	885.85	907.45	929.06	950.66	972.27	993.87	1,015.48	1,037.09	1,058.69	1,080.30	1,123.51	1,166.72	1,209.93	1,253.14	1,296.36
31*	826.07	848.40	870.72	893.05	915.37	937.70	960.03	982.35	1,004.68	1,027.00	1,049.33	1,071.66	1,093.98	1,116.31	1,160.96	1,205.61	1,250.26	1,294.92	1,339.57
32*	852.72	875.76	898.81	921.85	944.90	967.95	990.99	1,014.04	1,037.09	1,060.13	1,083.18	1,106.22	1,129.27	1,152.32	1,198.41	1,244.50	1,290.59	1,336.69	1,382.78
33*	879.36	903.13	926.90	950.66	974.43	998.20	1,021.96	1,045.73	1,069.50	1,093.26	1,117.03	1,140.79	1,164.56	1,188.33	1,235.86	1,283.39	1,330.93	1,378.46	1,425.99
34*	906.01	930.50	954.98	979.47	1,003.96	1,028.44	1,052.93	1,077.42	1,101.90	1,126.39	1,150.88	1,175.36	1,199.85	1,224.34	1,273.31	1,322.28	1,371.26	1,420.23	1,469.20
35*	932.66	957.86	983.07	1,008.28	1,033.49	1,058.69	1,083.90	1,109.11	1,134.31	1,159.52	1,184.73	1,209.93	1,235.14	1,260.35	1,310.76	1,361.17	1,411.59	1,462.00	1,512.42
36*	959.31	985.23	1,011.16	1,037.09	1,063.01	1,088.94	1,114.87	1,140.79	1,166.72	1,192.65	1,218.58	1,244.50	1,270.43	1,296.36	1,348.21	1,400.06	1,451.92	1,503.77	1,555.63
38*	1,012.60	1,039.97	1,067.33	1,094.70	1,122.07	1,149.44	1,176.80	1,204.17	1,231.54	1,258.91	1,286.27	1,313.64	1,341.01	1,368.38	1,423.11	1,477.85	1,532.58	1,587.32	1,642.05
40*	1,065.89	1,094.70	1,123.51	1,152.32	1,181.13	1,209.93	1,238.74	1,267.55	1,296.36	1,325.16	1,353.97	1,382.78	1,411.59	1,440.40	1,498.01	1,555.63	1,613.24	1,670.86	1,728.47
42*	1,119.19	1,149.44	1,179.68	1,209.93	1,240.18	1,270.43	1,300.68	1,330.93	1,361.17	1,391.42	1,421.67	1,451.92	1,482.17	1,512.42	1,572.91	1,633.41	1,693.90	1,754.40	1,814.90
44*	1,172.48	1,204.17	1,235.86	1,267.55	1,299.24	1,330.93	1,362.61	1,394.30	1,425.99	1,457.68	1,489.37	1,521.06	1,552.75	1,584.43	1,647.81	1,711.19	1,774.57	1,837.94	1,901.32
46*	1,225.78	1,258.91	1,292.04	1,325.16	1,358.29	1,391.42	1,424.55	1,457.68	1,490.81	1,523.94	1,557.07	1,590.20	1,623.33	1,656.45	1,722.71	1,788.97	1,855.23	1,921.49	1,987.74
48*	1,279.07	1,313.64	1,348.21	1,382.78	1,417.35	1,451.92	1,486.49	1,521.06	1,555.63	1,590.20	1,624.77	1,659.33	1,693.90	1,728.47	1,797.61	1,866.75	1,935.89	2,005.03	2,074.17
50*	1,332.37	1,368.38	1,404.39	1,440.40	1,476.41	1,512.42	1,548.42	1,584.43	1,620.44	1,656.45	1,692.46	1,728.47	1,764.48	1,800.49	1,872.51	1,944.53	2,016.55	2,088.57	2,160.59
52*	1,385.66	1,423.11	1,460.56	1,498.01	1,535.46	1,572.91	1,610.36	1,647.81	1,685.26	1,722.71	1,760.16	1,797.61	1,835.06	1,872.51	1,947.41	2,022.31	2,097.21	2,172.11	2,247.01
54*	1,438.96	1,477.85	1,516.74	1,555.63	1,594.52	1,633.41	1,672.30	1,711.19	1,750.08	1,788.97	1,827.86	1,866.75	1,905.64	1,944.53	2,022.31	2,100.09	2,177.88	2,255.66	2,333.44
56*	1,492.25	1,532.58	1,572.91	1,613.24	1,653.57	1,693.90	1,734.24	1,774.57	1,814.90	1,855.23	1,895.56	1,935.89	1,976.22	2,016.55	2,097.21	2,177.88	2,258.54	2,339.20	2,419.86
58*	1,545.54	1,587.32	1,629.09	1,670.86	1,712.63	1,754.40	1,796.17	1,837.94	1,879.71	1,921.49	1,963.26	2,005.03	2,046.80	2,088.57	2,172.11	2,255.66	2,339.20	2,422.74	2,506.28
60*	1,598.84	1,642.05	1,685.26	1,728.47	1,771.69	1,814.90	1,858.11	1,901.32	1,944.53	1,987.74	2,030.96	2,074.17	2,117.38	2,160.59	2,247.01	2,333.44	2,419.86	2,506.28	2,592.71
61+	<b>EMAIL FOR QUOTE</b>																		

\*Oversize charges will apply

**PRICE AS LISTED**



Brushed

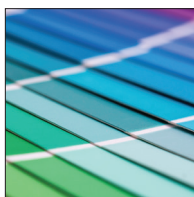

Painted

**OPTIONAL ANODIZED FINISHES - EMAIL FOR QUOTE**

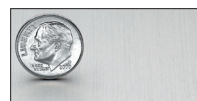

Clear

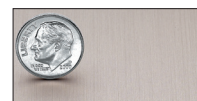

Champagne



Gold



Black



Light Bronze



Medium Bronze



Dark Bronze



# Your Logo 2" Deep Aluminum with Back

**PRICE PER LOGO.** Including standard mounting with pattern.

*Logos smaller than 10" x 10" or with more than 3 pieces email for quote*

Size	16"	17"	18"	19"	20"	21"	22"	23"	24"	25"	26"	27"	28"	29"	30"	31"	32"	33"	34"	35"	36"
16"	\$210.63	\$223.80	\$236.96	\$250.13	\$263.29	\$276.46	\$289.62	\$302.79	\$315.95	\$329.11	\$342.28	\$355.44	\$368.61	\$381.77	\$394.94	\$408.10	\$421.26	\$434.43	\$447.59	\$460.76	\$473.92
17	223.80	237.79	251.77	265.76	279.75	293.74	307.72	321.71	335.70	349.68	363.67	377.66	391.65	405.63	419.62	433.61	447.59	461.58	475.57	489.56	503.54
18	236.96	251.77	266.58	281.39	296.20	311.01	325.82	340.63	355.44	370.25	385.06	399.87	414.68	429.49	444.30	459.11	473.92	488.73	503.54	518.35	533.16
19	250.13	265.76	281.39	297.03	312.66	328.29	343.92	359.56	375.19	390.82	406.46	422.09	437.72	453.35	468.99	484.62	500.25	515.88	531.52	547.15	562.78
20	263.29	279.75	296.20	312.66	329.11	345.57	362.03	378.48	394.94	411.39	427.85	444.30	460.76	477.21	493.67	510.12	526.58	543.04	559.49	575.95	592.40
21	276.46	293.74	311.01	328.29	345.57	362.85	380.13	397.40	414.68	431.96	449.24	466.52	483.80	501.07	518.35	535.63	552.91	570.19	587.47	604.74	622.02
22	289.62	307.72	325.82	343.92	362.03	380.13	398.23	416.33	434.43	452.53	470.63	488.73	506.83	524.93	543.04	561.14	579.24	597.34	615.44	633.54	651.64
23	302.79	321.71	340.63	359.56	378.48	397.40	416.33	435.25	454.18	473.10	492.02	510.95	529.87	548.79	567.72	586.64	605.57	624.49	643.41	662.34	681.26
24	315.95	335.70	355.44	375.19	394.94	414.68	434.43	454.18	473.92	493.67	513.42	533.16	552.91	572.66	592.40	612.15	631.89	651.64	671.39	691.13	710.88
25	329.11	349.68	370.25	390.82	411.39	431.96	452.53	473.10	493.67	514.24	534.81	555.38	575.95	596.52	617.09	637.65	658.22	678.79	699.36	719.93	740.50
26	342.28	363.67	385.06	406.46	427.85	449.24	470.63	492.02	513.42	534.81	556.20	577.59	598.98	620.38	641.77	663.16	684.55	705.94	727.34	748.73	770.12
27	355.44	377.66	399.87	422.09	444.30	466.52	488.73	510.95	533.16	555.38	577.59	599.81	622.02	644.24	666.45	688.67	710.88	733.10	755.31	777.53	799.74
28	368.61	391.65	414.68	437.72	460.76	483.80	506.83	529.87	552.91	575.95	598.98	622.02	645.06	668.10	691.13	714.17	737.21	760.25	783.29	806.32	829.36
29	381.77	405.63	429.49	453.35	477.21	501.07	524.93	548.79	572.66	596.52	620.38	644.24	668.10	691.96	715.82	739.68	763.54	787.40	811.26	835.12	858.98
30*	394.94	419.62	444.30	468.99	493.67	518.35	543.04	567.72	592.40	617.09	641.77	666.45	691.13	715.82	740.50	765.18	789.87	814.55	839.23	863.92	888.60
31*	408.10	433.61	459.11	484.62	510.12	535.63	561.14	586.64	612.15	637.65	663.16	688.67	714.17	739.68	765.18	790.69	816.20	841.70	867.21	892.71	918.22
32*	421.26	447.59	473.92	500.25	526.58	552.91	579.24	605.57	631.89	658.22	684.55	710.88	737.21	763.54	789.87	816.20	842.52	868.85	895.18	921.51	947.84
33*	434.43	461.58	488.73	515.88	543.04	570.19	597.34	624.49	651.64	678.79	705.94	733.10	760.25	787.40	814.55	841.70	868.85	896.01	923.16	950.31	977.46
34*	447.59	475.57	503.54	531.52	559.49	587.47	615.44	643.41	671.39	699.36	727.34	755.31	783.29	811.26	839.23	867.21	895.18	923.16	951.13	979.11	1,007.08
35*	460.76	489.56	518.35	547.15	575.95	604.74	633.54	662.34	691.13	719.93	748.73	777.53	806.32	835.12	863.92	892.71	921.51	950.31	979.11	1,007.90	1,036.70
36*	473.92	503.54	533.16	562.78	592.40	622.02	651.64	681.26	710.88	740.50	770.12	799.74	829.36	858.98	888.60	918.22	947.84	977.46	1,007.08	1,036.70	1,066.32
38*	500.25	531.52	562.78	594.05	625.31	656.58	687.84	719.11	750.37	781.64	812.91	844.17	875.44	906.70	937.97	969.23	1,000.50	1,031.76	1,063.03	1,094.29	1,125.56
40*	526.58	559.49	592.40	625.31	658.22	691.13	724.05	756.96	789.87	822.78	855.69	888.60	921.51	954.42	987.33	1,020.24	1,053.15	1,086.07	1,118.98	1,151.89	1,184.80
42*	552.91	587.47	622.02	656.58	691.13	725.69	760.25	794.80	829.36	863.92	898.47	933.03	967.59	1,002.14	1,036.70	1,071.26	1,105.81	1,140.37	1,174.93	1,209.48	1,244.04
44*	579.24	615.44	651.64	687.84	724.05	760.25	796.45	832.65	868.85	905.06	941.26	977.46	1,013.66	1,049.86	1,086.07	1,122.27	1,158.47	1,194.67	1,230.87	1,267.08	1,303.28
46*	605.57	643.41	681.26	719.11	756.96	794.80	832.65	870.50	908.35	946.19	984.04	1,021.89	1,059.74	1,097.58	1,135.43	1,173.28	1,211.13	1,248.98	1,286.82	1,324.67	1,362.52
48*	631.89	671.39	710.88	750.37	789.87	829.36	868.85	908.35	947.84	987.33	1,026.83	1,066.32	1,105.81	1,145.31	1,184.80	1,224.29	1,263.78	1,303.28	1,342.77	1,382.26	1,421.76
50*	658.22	699.36	740.50	781.64	822.78	863.92	905.06	946.19	987.33	1,028.47	1,069.61	1,110.75	1,151.89	1,193.03	1,234.17	1,275.30	1,316.44	1,357.58	1,398.72	1,439.86	1,481.00
52*	684.55	727.34	770.12	812.91	855.69	898.47	941.26	984.04	1,026.83	1,069.61	1,112.39	1,155.18	1,197.96	1,240.75	1,283.53	1,326.32	1,369.10	1,411.88	1,454.67	1,497.45	1,540.24
54*	710.88	755.31	799.74	844.17	888.60	933.03	977.46	1,021.89	1,066.32	1,110.75	1,155.18	1,199.61	1,244.04	1,288.47	1,332.90	1,377.33	1,421.76	1,466.19	1,510.62	1,555.05	1,599.48
56*	737.21	783.29	829.36	875.44	921.51	967.59	1,013.66	1,059.74	1,105.81	1,151.89	1,197.96	1,244.04	1,290.11	1,336.19	1,382.26	1,428.34	1,474.41	1,520.49	1,566.57	1,612.64	1,658.72
58*	763.54	811.26	858.98	906.70	954.42	1,002.14	1,049.86	1,097.58	1,145.31	1,193.03	1,240.75	1,288.47	1,336.19	1,383.91	1,431.63	1,479.35	1,527.07	1,574.79	1,622.51	1,670.24	1,717.96
60*	789.87	839.23	888.60	937.97	987.33	1,036.70	1,086.07	1,135.43	1,184.80	1,234.17	1,283.53	1,332.90	1,382.26	1,431.63	1,481.00	1,530.36	1,579.73	1,629.10	1,678.46	1,727.83	1,777.20
61+	EMAIL FOR QUOTE																				

\*Oversize charges will apply

## PRICE AS LISTED



Brushed

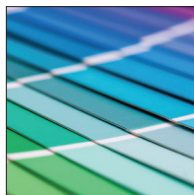

Painted

## OPTIONAL ANODIZED FINISHES - EMAIL FOR QUOTE



Clear



Champagne



Gold



Black



Light Bronze



Medium Bronze



Dark Bronze

Your Logo 2" Deep Aluminum with Back

PRICE PER LOGO. Including standard mounting with pattern.

Logos smaller than 10" x 10" or with more than 3 pieces email for quote

Size	37"*	38"*	39"*	40"*	41"*	42"*	43"*	44"*	45"*	46"*	47"*	48"	49"*	50"	52"*	54"	56"*	58"	60"*
16"	\$487.09	\$500.25	\$513.42	\$526.58	\$539.74	\$552.91	\$566.07	\$579.24	\$592.40	\$605.57	\$618.73	\$631.89	\$645.06	\$658.22	\$684.55	\$710.88	\$737.21	\$763.54	\$789.87
17	517.53	531.52	545.50	559.49	573.48	587.47	601.45	615.44	629.43	643.41	657.40	671.39	685.38	699.36	727.34	755.31	783.29	811.26	839.23
18	547.97	562.78	577.59	592.40	607.21	622.02	636.83	651.64	666.45	681.26	696.07	710.88	725.69	740.50	770.12	799.74	829.36	858.98	888.60
19	578.41	594.05	609.68	625.31	640.95	656.58	672.21	687.84	703.48	719.11	734.74	750.37	766.01	781.64	812.91	844.17	875.44	906.70	937.97
20	608.86	625.31	641.77	658.22	674.68	691.13	707.59	724.05	740.50	756.96	773.41	789.87	806.32	822.78	855.69	888.60	921.51	954.42	987.33
21	639.30	656.58	673.86	691.13	708.41	725.69	742.97	760.25	777.53	794.80	812.08	829.36	846.64	863.92	898.47	933.03	967.59	1,002.14	1,036.70
22	669.74	687.84	705.94	724.05	742.15	760.25	778.35	796.45	814.55	832.65	850.75	868.85	886.95	905.06	941.26	977.46	1,013.66	1,049.86	1,086.07
23	700.19	719.11	738.03	756.96	775.88	794.80	813.73	832.65	851.58	870.50	889.42	908.35	927.27	946.19	984.04	1,021.89	1,059.74	1,097.58	1,135.43
24	730.63	750.37	770.12	789.87	809.61	829.36	849.11	868.85	888.60	908.35	928.09	947.84	967.59	987.33	1,026.83	1,066.32	1,105.81	1,145.31	1,184.80
25	761.07	781.64	802.21	822.78	843.35	863.92	884.49	905.06	925.63	946.19	966.76	987.33	1,007.90	1,028.47	1,069.61	1,110.75	1,151.89	1,193.03	1,234.17
26	791.51	812.91	834.30	855.69	877.08	898.47	919.87	941.26	962.65	984.04	1,005.43	1,026.83	1,048.22	1,069.61	1,112.39	1,155.18	1,197.96	1,240.75	1,283.53
27	821.96	844.17	866.39	888.60	910.82	933.03	955.24	977.46	999.67	1,021.89	1,044.10	1,066.32	1,088.53	1,110.75	1,155.18	1,199.61	1,244.04	1,288.47	1,332.90
28	852.40	875.44	898.47	921.51	944.55	967.59	990.62	1,013.66	1,036.70	1,059.74	1,082.77	1,105.81	1,128.85	1,151.89	1,197.96	1,244.04	1,290.11	1,336.19	1,382.26
29	882.84	906.70	930.56	954.42	978.28	1,002.14	1,026.00	1,049.86	1,073.72	1,097.58	1,121.45	1,145.31	1,169.17	1,193.03	1,240.75	1,288.47	1,336.19	1,383.91	1,431.63
30*	913.28	937.97	962.65	987.33	1,012.02	1,036.70	1,061.38	1,086.07	1,110.75	1,135.43	1,160.12	1,184.80	1,209.48	1,234.17	1,283.53	1,332.90	1,382.26	1,431.63	1,481.00
31*	943.73	969.23	994.74	1,020.24	1,045.75	1,071.26	1,096.76	1,122.27	1,147.77	1,173.28	1,198.79	1,224.29	1,249.80	1,275.30	1,326.32	1,377.33	1,428.34	1,479.35	1,530.36
32*	974.17	1,000.50	1,026.83	1,053.15	1,079.48	1,105.81	1,132.14	1,158.47	1,184.80	1,211.13	1,237.46	1,263.78	1,290.11	1,316.44	1,369.10	1,421.76	1,474.41	1,527.07	1,579.73
33*	1,004.61	1,031.76	1,058.91	1,086.07	1,113.22	1,140.37	1,167.52	1,194.67	1,221.82	1,248.98	1,276.13	1,303.28	1,330.43	1,357.58	1,411.88	1,466.19	1,520.49	1,574.79	1,629.10
34*	1,035.05	1,063.03	1,091.00	1,118.98	1,146.95	1,174.93	1,202.90	1,230.87	1,258.85	1,286.82	1,314.80	1,342.77	1,370.75	1,398.72	1,454.67	1,510.62	1,566.57	1,622.51	1,678.46
35*	1,065.50	1,094.29	1,123.09	1,151.89	1,180.68	1,209.48	1,238.28	1,267.08	1,295.87	1,324.67	1,353.47	1,382.26	1,411.06	1,439.86	1,497.45	1,555.05	1,612.64	1,670.24	1,727.83
36*	1,095.94	1,125.56	1,155.18	1,184.80	1,214.42	1,244.04	1,273.66	1,303.28	1,332.90	1,362.52	1,392.14	1,421.76	1,451.38	1,481.00	1,540.24	1,599.48	1,658.72	1,717.96	1,777.20
38*	1,156.82	1,188.09	1,219.36	1,250.62	1,281.89	1,313.15	1,344.42	1,375.68	1,406.95	1,438.21	1,469.48	1,500.74	1,532.01	1,563.27	1,625.81	1,688.34	1,750.87	1,813.40	1,875.93
40*	1,217.71	1,250.62	1,283.53	1,316.44	1,349.35	1,382.26	1,415.18	1,448.09	1,481.00	1,513.91	1,546.82	1,579.73	1,612.64	1,645.55	1,711.37	1,777.20	1,843.02	1,908.84	1,974.66
42*	1,278.59	1,313.15	1,347.71	1,382.26	1,416.82	1,451.38	1,485.93	1,520.49	1,555.05	1,589.60	1,624.16	1,658.72	1,693.27	1,727.83	1,796.94	1,866.06	1,935.17	2,004.28	2,073.39
44*	1,339.48	1,375.68	1,411.88	1,448.09	1,484.29	1,520.49	1,556.69	1,592.89	1,629.10	1,665.30	1,701.50	1,737.70	1,773.90	1,810.11	1,882.51	1,954.91	2,027.32	2,099.72	2,172.13
46*	1,400.37	1,438.21	1,476.06	1,513.91	1,551.76	1,589.60	1,627.45	1,665.30	1,703.15	1,740.99	1,778.84	1,816.69	1,854.54	1,892.38	1,968.08	2,043.77	2,119.47	2,195.16	2,270.86
48*	1,461.25	1,500.74	1,540.24	1,579.73	1,619.22	1,658.72	1,698.21	1,737.70	1,777.20	1,816.69	1,856.18	1,895.67	1,935.17	1,974.66	2,053.65	2,132.63	2,211.62	2,290.61	2,369.59
50*	1,522.14	1,563.27	1,604.41	1,645.55	1,686.69	1,727.83	1,768.97	1,810.11	1,851.25	1,892.38	1,933.52	1,974.66	2,015.80	2,056.94	2,139.22	2,221.49	2,303.77	2,386.05	2,468.33
52*	1,583.02	1,625.81	1,668.59	1,711.37	1,754.16	1,796.94	1,839.73	1,882.51	1,925.29	1,968.08	2,010.86	2,053.65	2,096.43	2,139.22	2,224.78	2,310.35	2,395.92	2,481.49	2,567.06
54*	1,643.91	1,688.34	1,732.77	1,777.20	1,821.63	1,866.06	1,910.48	1,954.91	1,999.34	2,043.77	2,088.20	2,132.63	2,177.06	2,221.49	2,310.35	2,399.21	2,488.07	2,576.93	2,665.79
56*	1,704.79	1,750.87	1,796.94	1,843.02	1,889.09	1,935.17	1,981.24	2,027.32	2,073.39	2,119.47	2,165.54	2,211.62	2,257.70	2,303.77	2,395.92	2,488.07	2,580.22	2,672.37	2,764.52
58*	1,765.68	1,813.40	1,861.12	1,908.84	1,956.56	2,004.28	2,052.00	2,099.72	2,147.44	2,195.16	2,242.89	2,290.61	2,338.33	2,386.05	2,481.49	2,576.93	2,672.37	2,767.81	2,863.26
60*	1,826.56	1,875.93	1,925.29	1,974.66	2,024.03	2,073.39	2,122.76	2,172.13	2,221.49	2,270.86	2,320.23	2,369.59	2,418.96	2,468.33	2,567.06	2,665.79	2,764.52	2,863.26	2,961.99
61+	EMAIL FOR QUOTE																		

\*Oversize charges will apply

PRICE AS LISTED



Brushed



Painted

OPTIONAL ANODIZED FINISHES - EMAIL FOR QUOTE



Clear



Champagne

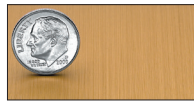

Gold



Black



Light Bronze

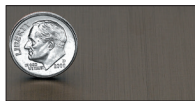

Medium Bronze



Dark Bronze

# Your Logo 3" Deep Aluminum without Back

**PRICE PER LOGO.** Including standard mounting with pattern.

*Logos smaller than 10" x 10" or with more than 3 pieces email for quote*

Size	16"	17"	18"	19"	20"	21"	22"	23"	24"	25"	26**	27"	28**	29"	30**	31"	32**	33"	34**	35"	36**
16"	\$222.78	\$236.71	\$250.63	\$264.56	\$278.48	\$292.40	\$306.33	\$320.25	\$334.17	\$348.10	\$362.02	\$375.95	\$389.87	\$403.79	\$417.72	\$431.64	\$445.56	\$459.49	\$473.41	\$487.34	\$501.26
17	236.71	251.50	266.30	281.09	295.88	310.68	325.47	340.27	355.06	369.85	384.65	399.44	414.24	429.03	443.82	458.62	473.41	488.21	503.00	517.79	532.59
18	250.63	266.30	281.96	297.63	313.29	328.95	344.62	360.28	375.95	391.61	407.27	422.94	438.60	454.27	469.93	485.60	501.26	516.92	532.59	548.25	563.92
19	264.56	281.09	297.63	314.16	330.69	347.23	363.76	380.30	396.83	413.37	429.90	446.44	462.97	479.50	496.04	512.57	529.11	545.64	562.18	578.71	595.25
20	278.48	295.88	313.29	330.69	348.10	365.50	382.91	400.31	417.72	435.12	452.53	469.93	487.34	504.74	522.15	539.55	556.95	574.36	591.76	609.17	626.57
21	292.40	310.68	328.95	347.23	365.50	383.78	402.05	420.33	438.60	456.88	475.15	493.43	511.70	529.98	548.25	566.53	584.80	603.08	621.35	639.63	657.90
22	306.33	325.47	344.62	363.76	382.91	402.05	421.20	440.34	459.49	478.63	497.78	516.92	536.07	555.21	574.36	593.50	612.65	631.80	650.94	670.09	689.23
23	320.25	340.27	360.28	380.30	400.31	420.33	440.34	460.36	480.37	500.39	520.41	540.42	560.44	580.45	600.47	620.48	640.50	660.51	680.53	700.54	720.56
24	334.17	355.06	375.95	396.83	417.72	438.60	459.49	480.37	501.26	522.15	543.03	563.92	584.80	605.69	626.57	647.46	668.34	689.23	710.12	731.00	751.89
25	348.10	369.85	391.61	413.37	435.12	456.88	478.63	500.39	522.15	543.90	565.66	587.41	609.17	630.92	652.68	674.44	696.19	717.95	739.70	761.46	783.22
26	362.02	384.65	407.27	429.90	452.53	475.15	497.78	520.41	543.03	565.66	588.28	610.91	633.54	656.16	678.79	701.41	724.04	746.67	769.29	791.92	814.54
27	375.95	399.44	422.94	446.44	469.93	493.43	516.92	540.42	563.92	587.41	610.91	634.41	657.90	681.40	704.89	728.39	751.89	775.38	798.88	822.38	845.87
28	389.87	414.24	438.60	462.97	487.34	511.70	536.07	560.44	584.80	609.17	633.54	657.90	682.27	706.64	731.00	755.37	779.73	804.10	828.47	852.83	877.20
29	403.79	429.03	454.27	479.50	504.74	529.98	555.21	580.45	605.69	630.92	656.16	681.40	706.64	731.87	757.11	782.35	807.58	832.82	858.06	883.29	908.53
30*	417.72	443.82	469.93	496.04	522.15	548.25	574.36	600.47	626.57	652.68	678.79	704.89	731.00	757.11	783.22	809.32	835.43	861.54	887.64	913.75	939.86
31*	431.64	458.62	485.60	512.57	539.55	566.53	593.50	620.48	647.46	674.44	701.41	728.39	755.37	782.35	809.32	836.30	863.28	890.25	917.23	944.21	971.19
32*	445.56	473.41	501.26	529.11	556.95	584.80	612.65	640.50	668.34	696.19	724.04	751.89	779.73	807.58	835.43	863.28	891.12	918.97	946.82	974.67	1,002.51
33*	459.49	488.21	516.92	545.64	574.36	603.08	631.80	660.51	689.23	717.95	746.67	775.38	804.10	832.82	861.54	890.25	918.97	947.69	976.41	1,005.13	1,033.84
34*	473.41	503.00	532.59	562.18	591.76	621.35	650.94	680.53	710.12	739.70	769.29	798.88	828.47	858.06	887.64	917.23	946.82	976.41	1,006.00	1,035.58	1,065.17
35*	487.34	517.79	548.25	578.71	609.17	639.63	670.09	700.54	731.00	761.46	791.92	822.38	852.83	883.29	913.75	944.21	974.67	1,005.13	1,035.58	1,066.04	1,096.50
36*	501.26	532.59	563.92	595.25	626.57	657.90	689.23	720.56	751.89	783.22	814.54	845.87	877.20	908.53	939.86	971.19	1,002.51	1,033.84	1,065.17	1,096.50	1,127.83
38*	529.11	562.18	595.25	628.31	661.38	694.45	727.52	760.59	793.66	826.73	859.80	892.87	925.93	959.00	992.07	1,025.14	1,058.21	1,091.28	1,124.35	1,157.42	1,190.49
40*	556.95	591.76	626.57	661.38	696.19	731.00	765.81	800.62	835.43	870.24	905.05	939.86	974.67	1,009.48	1,044.29	1,079.10	1,113.90	1,148.71	1,183.52	1,218.33	1,253.14
42*	584.80	621.35	657.90	694.45	731.00	767.55	804.10	840.65	877.20	913.75	950.30	986.85	1,023.40	1,059.95	1,096.50	1,133.05	1,169.60	1,206.15	1,242.70	1,279.25	1,315.80
44*	612.65	650.94	689.23	727.52	765.81	804.10	842.39	880.68	918.97	957.26	995.55	1,033.84	1,072.13	1,110.42	1,148.71	1,187.00	1,225.29	1,263.59	1,301.88	1,340.17	1,378.46
46*	640.50	680.53	720.56	760.59	800.62	840.65	880.68	920.71	960.74	1,000.77	1,040.81	1,080.84	1,120.87	1,160.90	1,200.93	1,240.96	1,280.99	1,321.02	1,361.05	1,401.08	1,441.11
48*	668.34	710.12	751.89	793.66	835.43	877.20	918.97	960.74	1,002.51	1,044.29	1,086.06	1,127.83	1,169.60	1,211.37	1,253.14	1,294.91	1,336.68	1,378.46	1,420.23	1,462.00	1,503.77
50*	696.19	739.70	783.22	826.73	870.24	913.75	957.26	1,000.77	1,044.29	1,087.80	1,131.31	1,174.82	1,218.33	1,261.84	1,305.36	1,348.87	1,392.38	1,435.89	1,479.40	1,522.92	1,566.43
52*	724.04	769.29	814.54	859.80	905.05	950.30	995.55	1,040.81	1,086.06	1,131.31	1,176.56	1,221.81	1,267.07	1,312.32	1,357.57	1,402.82	1,448.07	1,493.33	1,538.58	1,583.83	1,629.08
54*	751.89	798.88	845.87	892.87	939.86	986.85	1,033.84	1,080.84	1,127.83	1,174.82	1,221.81	1,268.81	1,315.80	1,362.79	1,409.78	1,456.78	1,503.77	1,550.76	1,597.76	1,644.75	1,691.74
56*	779.73	828.47	877.20	925.93	974.67	1,023.40	1,072.13	1,120.87	1,169.60	1,218.33	1,267.07	1,315.80	1,364.53	1,413.27	1,462.00	1,510.73	1,559.46	1,608.20	1,656.93	1,705.66	1,754.40
58*	807.58	858.06	908.53	959.00	1,009.48	1,059.95	1,110.42	1,160.90	1,211.37	1,261.84	1,312.32	1,362.79	1,413.27	1,463.74	1,514.21	1,564.69	1,615.16	1,665.63	1,716.11	1,766.58	1,817.05
60*	835.43	887.64	939.86	992.07	1,044.29	1,096.50	1,148.71	1,200.93	1,253.14	1,305.36	1,357.57	1,409.78	1,462.00	1,514.21	1,566.43	1,618.64	1,670.85	1,723.07	1,775.28	1,827.50	1,879.71
61+	EMAIL FOR QUOTE																				

\*Oversize charges will apply

## PRICE AS LISTED



Brushed

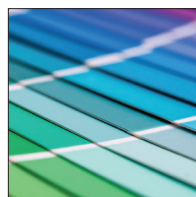

Painted

## OPTIONAL ANODIZED FINISHES - EMAIL FOR QUOTE



Clear

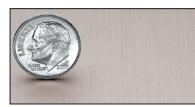

Champagne



Gold

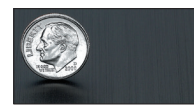

Black



Light Bronze

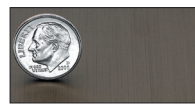

Medium Bronze

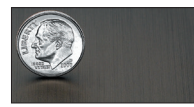

Dark Bronze



# Your Logo 3" Deep Aluminum without Back

**PRICE PER LOGO.** Including standard mounting with pattern.

*Logos smaller than 10" x 10" or with more than 3 pieces email for quote*

Size	37"*	38"*	39"*	40"*	41"*	42"*	43"*	44"*	45"*	46"*	47"*	48"	49"*	50"	52"*	54"	56"*	58"	60"*
16"	\$515.18	\$529.11	\$543.03	\$556.95	\$570.88	\$584.80	\$598.73	\$612.65	\$626.57	\$640.50	\$654.42	\$668.34	\$682.27	\$696.19	\$724.04	\$751.89	\$779.73	\$807.58	\$835.43
17	547.38	562.18	576.97	591.76	606.56	621.35	636.15	650.94	665.73	680.53	695.32	710.12	724.91	739.70	769.29	798.88	828.47	858.06	887.64
18	579.58	595.25	610.91	626.57	642.24	657.90	673.57	689.23	704.89	720.56	736.22	751.89	767.55	783.22	814.54	845.87	877.20	908.53	939.86
19	611.78	628.31	644.85	661.38	677.92	694.45	710.99	727.52	744.06	760.59	777.12	793.66	810.19	826.73	859.80	892.87	925.93	959.00	992.07
20	643.98	661.38	678.79	696.19	713.60	731.00	748.41	765.81	783.22	800.62	818.03	835.43	852.83	870.24	905.05	939.86	974.67	1,009.48	1,044.29
21	676.18	694.45	712.73	731.00	749.28	767.55	785.83	804.10	822.38	840.65	858.93	877.20	895.48	913.75	950.30	986.85	1,023.40	1,059.95	1,096.50
22	708.38	727.52	746.67	765.81	784.96	804.10	823.25	842.39	861.54	880.68	899.83	918.97	938.12	957.26	995.55	1,033.84	1,072.13	1,110.42	1,148.71
23	740.57	760.59	780.61	800.62	820.64	840.65	860.67	880.68	900.70	920.71	940.73	960.74	980.76	1,000.77	1,040.81	1,080.84	1,120.87	1,160.90	1,200.93
24	772.77	793.66	814.54	835.43	856.32	877.20	898.09	918.97	939.86	960.74	981.63	1,002.51	1,023.40	1,044.29	1,086.06	1,127.83	1,169.60	1,211.37	1,253.14
25	804.97	826.73	848.48	870.24	892.00	913.75	935.51	957.26	979.02	1,000.77	1,022.53	1,044.29	1,066.04	1,087.80	1,131.31	1,174.82	1,218.33	1,261.84	1,305.36
26	837.17	859.80	882.42	905.05	927.67	950.30	972.93	995.55	1,018.18	1,040.81	1,063.43	1,086.06	1,108.68	1,131.31	1,176.56	1,221.81	1,267.07	1,312.32	1,357.57
27	869.37	892.87	916.36	939.86	963.35	986.85	1,010.35	1,033.84	1,057.34	1,080.84	1,104.33	1,127.83	1,151.33	1,174.82	1,221.81	1,268.81	1,315.80	1,362.79	1,409.78
28	901.57	925.93	950.30	974.67	999.03	1,023.40	1,047.77	1,072.13	1,096.50	1,120.87	1,145.23	1,169.60	1,193.97	1,218.33	1,267.07	1,315.80	1,364.53	1,413.27	1,462.00
29	933.77	959.00	984.24	1,009.48	1,034.71	1,059.95	1,085.19	1,110.42	1,135.66	1,160.90	1,186.13	1,211.37	1,236.61	1,261.84	1,312.32	1,362.79	1,413.27	1,463.74	1,514.21
30*	965.97	992.07	1,018.18	1,044.29	1,070.39	1,096.50	1,122.61	1,148.71	1,174.82	1,200.93	1,227.04	1,253.14	1,279.25	1,305.36	1,357.57	1,409.78	1,462.00	1,514.21	1,566.43
31*	998.16	1,025.14	1,052.12	1,079.10	1,106.07	1,133.05	1,160.03	1,187.00	1,213.98	1,240.96	1,267.94	1,294.91	1,321.89	1,348.87	1,402.82	1,456.78	1,510.73	1,564.69	1,618.64
32*	1,030.36	1,058.21	1,086.06	1,113.90	1,141.75	1,169.60	1,197.45	1,225.29	1,253.14	1,280.99	1,308.84	1,336.68	1,364.53	1,392.38	1,448.07	1,503.77	1,559.46	1,615.16	1,670.85
33*	1,062.56	1,091.28	1,120.00	1,148.71	1,177.43	1,206.15	1,234.87	1,263.59	1,292.30	1,321.02	1,349.74	1,378.46	1,407.17	1,435.89	1,493.33	1,550.76	1,608.20	1,665.63	1,723.07
34*	1,094.76	1,124.35	1,153.94	1,183.52	1,213.11	1,242.70	1,272.29	1,301.88	1,331.46	1,361.05	1,390.64	1,420.23	1,449.82	1,479.40	1,538.58	1,597.76	1,656.93	1,716.11	1,775.28
35*	1,126.96	1,157.42	1,187.87	1,218.33	1,248.79	1,279.25	1,309.71	1,340.17	1,370.62	1,401.08	1,431.54	1,462.00	1,492.46	1,522.92	1,583.83	1,644.75	1,705.66	1,766.58	1,827.50
36*	1,159.16	1,190.49	1,221.81	1,253.14	1,284.47	1,315.80	1,347.13	1,378.46	1,409.78	1,441.11	1,472.44	1,503.77	1,535.10	1,566.43	1,629.08	1,691.74	1,754.40	1,817.05	1,879.71
38*	1,223.55	1,256.62	1,289.69	1,322.76	1,355.83	1,388.90	1,421.97	1,455.04	1,488.11	1,521.17	1,554.24	1,587.31	1,620.38	1,653.45	1,719.59	1,785.73	1,851.86	1,918.00	1,984.14
40*	1,287.95	1,322.76	1,357.57	1,392.38	1,427.19	1,462.00	1,496.81	1,531.62	1,566.43	1,601.24	1,636.05	1,670.85	1,705.66	1,740.47	1,810.09	1,879.71	1,949.33	2,018.95	2,088.57
42*	1,352.35	1,388.90	1,425.45	1,462.00	1,498.55	1,535.10	1,571.65	1,608.20	1,644.75	1,681.30	1,717.85	1,754.40	1,790.95	1,827.50	1,900.60	1,973.70	2,046.80	2,119.90	2,193.00
44*	1,416.75	1,455.04	1,493.33	1,531.62	1,569.91	1,608.20	1,646.49	1,684.78	1,723.07	1,761.36	1,799.65	1,837.94	1,876.23	1,914.52	1,991.10	2,067.68	2,144.26	2,220.84	2,297.42
46*	1,481.14	1,521.17	1,561.21	1,601.24	1,641.27	1,681.30	1,721.33	1,761.36	1,801.39	1,841.42	1,881.45	1,921.48	1,961.51	2,001.54	2,081.61	2,161.67	2,241.73	2,321.79	2,401.85
48*	1,545.54	1,587.31	1,629.08	1,670.85	1,712.63	1,754.40	1,796.17	1,837.94	1,879.71	1,921.48	1,963.25	2,005.02	2,046.80	2,088.57	2,172.11	2,255.65	2,339.19	2,422.74	2,506.28
50*	1,609.94	1,653.45	1,696.96	1,740.47	1,783.99	1,827.50	1,871.01	1,914.52	1,958.03	2,001.54	2,045.06	2,088.57	2,132.08	2,175.59	2,262.61	2,349.64	2,436.66	2,523.68	2,610.71
52*	1,674.34	1,719.59	1,764.84	1,810.09	1,855.34	1,900.60	1,945.85	1,991.10	2,036.35	2,081.61	2,126.86	2,172.11	2,217.36	2,262.61	2,353.12	2,443.62	2,534.13	2,624.63	2,715.14
54*	1,738.73	1,785.73	1,832.72	1,879.71	1,926.70	1,973.70	2,020.69	2,067.68	2,114.67	2,161.67	2,208.66	2,255.65	2,302.65	2,349.64	2,443.62	2,537.61	2,631.59	2,725.58	2,819.56
56*	1,803.13	1,851.86	1,900.60	1,949.33	1,998.06	2,046.80	2,095.53	2,144.26	2,193.00	2,241.73	2,290.46	2,339.19	2,387.93	2,436.66	2,534.13	2,631.59	2,729.06	2,826.53	2,923.99
58*	1,867.53	1,918.00	1,968.48	2,018.95	2,069.42	2,119.90	2,170.37	2,220.84	2,271.32	2,321.79	2,372.26	2,422.74	2,473.21	2,523.68	2,624.63	2,725.58	2,826.53	2,927.47	3,028.42
60*	1,931.93	1,984.14	2,036.35	2,088.57	2,140.78	2,193.00	2,245.21	2,297.42	2,349.64	2,401.85	2,454.07	2,506.28	2,558.49	2,610.71	2,715.14	2,819.56	2,923.99	3,028.42	3,132.85
61+	<b>EMAIL FOR QUOTE</b>																		

\*Oversize charges will apply

## PRICE AS LISTED



Brushed

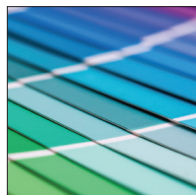

Painted

## OPTIONAL ANODIZED FINISHES - EMAIL FOR QUOTE



Clear



Champagne



Gold



Black



Light Bronze



Medium Bronze



Dark Bronze

# Your Logo 3" Deep Aluminum with Back

**PRICE PER LOGO.** Including standard mounting with pattern.

*Logos smaller than 10" x 10" or with more than 3 pieces email for quote*

Size	16"	17"	18"	19"	20"	21"	22"	23"	24"	25"	26**	27"	28"*	29"	30"*	31"	32**	33"	34"*	35"	36"*
16"	\$254.51	\$270.42	\$286.33	\$302.24	\$318.14	\$334.05	\$349.96	\$365.86	\$381.77	\$397.68	\$413.58	\$429.49	\$445.40	\$461.30	\$477.21	\$493.12	\$509.02	\$524.93	\$540.84	\$556.75	\$572.65
17	270.42	287.32	304.22	321.13	338.03	354.93	371.83	388.73	405.63	422.53	439.43	456.33	473.23	490.14	507.04	523.94	540.84	557.74	574.64	591.54	608.44
18	286.33	304.22	322.12	340.01	357.91	375.80	393.70	411.60	429.49	447.39	465.28	483.18	501.07	518.97	536.86	554.76	572.65	590.55	608.44	626.34	644.23
19	302.24	321.13	340.01	358.90	377.79	396.68	415.57	434.46	453.35	472.24	491.13	510.02	528.91	547.80	566.69	585.58	604.47	623.36	642.25	661.13	680.02
20	318.14	338.03	357.91	377.79	397.68	417.56	437.44	457.33	477.21	497.09	516.98	536.86	556.75	576.63	596.51	616.40	636.28	656.16	676.05	695.93	715.81
21	334.05	354.93	375.80	396.68	417.56	438.44	459.32	480.19	501.07	521.95	542.83	563.70	584.58	605.46	626.34	647.22	668.09	688.97	709.85	730.73	751.60
22	349.96	371.83	393.70	415.57	437.44	459.32	481.19	503.06	524.93	546.80	568.68	590.55	612.42	634.29	656.16	678.04	699.91	721.78	743.65	765.52	787.40
23	365.86	388.73	411.60	434.46	457.33	480.19	503.06	525.93	548.79	571.66	594.52	617.39	640.26	663.12	685.99	708.86	731.72	754.59	777.45	800.32	823.19
24	381.77	405.63	429.49	453.35	477.21	501.07	524.93	548.79	572.65	596.51	620.37	644.23	668.09	691.95	715.81	739.67	763.53	787.40	811.26	835.12	858.98
25	397.68	422.53	447.39	472.24	497.09	521.95	546.80	571.66	596.51	621.37	646.22	671.08	695.93	720.79	745.64	770.49	795.35	820.20	845.06	869.91	894.77
26	413.58	439.43	465.28	491.13	516.98	542.83	568.68	594.52	620.37	646.22	672.07	697.92	723.77	749.62	775.47	801.31	827.16	853.01	878.86	904.71	930.56
27	429.49	456.33	483.18	510.02	536.86	563.70	590.55	617.39	644.23	671.08	697.92	724.76	751.60	778.45	805.29	832.13	858.98	885.82	912.66	939.50	966.35
28	445.40	473.23	501.07	528.91	556.75	584.58	612.42	640.26	668.09	695.93	723.77	751.60	779.44	807.28	835.12	862.95	890.79	918.63	946.46	974.30	1,002.14
29	461.30	490.14	518.97	547.80	576.63	605.46	634.29	663.12	691.95	720.79	749.62	778.45	807.28	836.11	864.94	893.77	922.60	951.43	980.27	1,009.10	1,037.93
30*	477.21	507.04	536.86	566.69	596.51	626.34	656.16	685.99	715.81	745.64	775.47	805.29	835.12	864.94	894.77	924.59	954.42	984.24	1,014.07	1,043.89	1,073.72
31*	493.12	523.94	554.76	585.58	616.40	647.22	678.04	708.86	739.67	770.49	801.31	832.13	862.95	893.77	924.59	955.41	986.23	1,017.05	1,047.87	1,078.69	1,109.51
32*	509.02	540.84	572.65	604.47	636.28	668.09	699.91	731.72	763.53	795.35	827.16	858.98	890.79	922.60	954.42	986.23	1,018.04	1,049.86	1,081.67	1,113.49	1,145.30
33*	524.93	557.74	590.55	623.36	656.16	688.97	721.78	754.59	787.40	820.20	853.01	885.82	918.63	951.43	984.24	1,017.05	1,049.86	1,082.67	1,115.47	1,148.28	1,181.09
34*	540.84	574.64	608.44	642.25	676.05	709.85	743.65	777.45	811.26	845.06	878.86	912.66	946.46	980.27	1,014.07	1,047.87	1,081.67	1,115.47	1,149.28	1,183.08	1,216.88
35*	556.75	591.54	626.34	661.13	695.93	730.73	765.52	800.32	835.12	869.91	904.71	939.50	974.30	1,009.10	1,043.89	1,078.69	1,113.49	1,148.28	1,183.08	1,217.88	1,252.67
36*	572.65	608.44	644.23	680.02	715.81	751.60	787.40	823.19	858.98	894.77	930.56	966.35	1,002.14	1,037.93	1,073.72	1,109.51	1,145.30	1,181.09	1,216.88	1,252.67	1,288.46
38*	604.47	642.25	680.02	717.80	755.58	793.36	831.14	868.92	906.70	944.48	982.25	1,020.03	1,057.81	1,095.59	1,133.37	1,171.15	1,208.93	1,246.71	1,284.49	1,322.26	1,360.04
40*	636.28	676.05	715.81	755.58	795.35	835.12	874.88	914.65	954.42	994.18	1,033.95	1,073.72	1,113.49	1,153.25	1,193.02	1,232.79	1,272.55	1,312.32	1,352.09	1,391.86	1,431.62
42*	668.09	709.85	751.60	793.36	835.12	876.87	918.63	960.38	1,002.14	1,043.89	1,085.65	1,127.40	1,169.16	1,210.92	1,252.67	1,294.43	1,336.18	1,377.94	1,419.69	1,461.45	1,503.20
44*	699.91	743.65	787.40	831.14	874.88	918.63	962.37	1,006.11	1,049.86	1,093.60	1,137.35	1,181.09	1,224.83	1,268.58	1,312.32	1,356.07	1,399.81	1,443.55	1,487.30	1,531.04	1,574.79
46*	731.72	777.45	823.19	868.92	914.65	960.38	1,006.11	1,051.85	1,097.58	1,143.31	1,189.04	1,234.78	1,280.51	1,326.24	1,371.97	1,417.71	1,463.44	1,509.17	1,554.90	1,600.63	1,646.37
48*	763.53	811.26	858.98	906.70	954.42	1,002.14	1,049.86	1,097.58	1,145.30	1,193.02	1,240.74	1,288.46	1,336.18	1,383.90	1,431.62	1,479.34	1,527.06	1,574.79	1,622.51	1,670.23	1,717.95
50*	795.35	845.06	894.77	944.48	994.18	1,043.89	1,093.60	1,143.31	1,193.02	1,242.73	1,292.44	1,342.15	1,391.86	1,441.57	1,491.27	1,540.98	1,590.69	1,640.40	1,690.11	1,739.82	1,789.53
52*	827.16	878.86	930.56	982.25	1,033.95	1,085.65	1,137.35	1,189.04	1,240.74	1,292.44	1,344.14	1,395.83	1,447.53	1,499.23	1,550.93	1,602.62	1,654.32	1,706.02	1,757.71	1,809.41	1,861.11
54*	858.98	912.66	966.35	1,020.03	1,073.72	1,127.40	1,181.09	1,234.78	1,288.46	1,342.15	1,395.83	1,449.52	1,503.20	1,556.89	1,610.58	1,664.26	1,717.95	1,771.63	1,825.32	1,879.00	1,932.69
56*	890.79	946.46	1,002.14	1,057.81	1,113.49	1,169.16	1,224.83	1,280.51	1,336.18	1,391.86	1,447.53	1,503.20	1,558.88	1,614.55	1,670.23	1,725.90	1,781.57	1,837.25	1,892.92	1,948.60	2,004.27
58*	922.60	980.27	1,037.93	1,095.59	1,153.25	1,210.92	1,268.58	1,326.24	1,383.90	1,441.57	1,499.23	1,556.89	1,614.55	1,672.22	1,729.88	1,787.54	1,845.20	1,902.86	1,960.53	2,018.19	2,075.85
60*	954.42	1,014.07	1,073.72	1,133.37	1,193.02	1,252.67	1,312.32	1,371.97	1,431.62	1,491.27	1,550.93	1,610.58	1,670.23	1,729.88	1,789.53	1,849.18	1,908.83	1,968.48	2,028.13	2,087.78	2,147.43
61+	EMAIL FOR QUOTE																				

\*Oversize charges will apply

## PRICE AS LISTED

## OPTIONAL ANODIZED FINISHES - EMAIL FOR QUOTE



Brushed

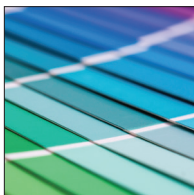

Painted



Clear



Champagne



Gold



Black



Light Bronze



Medium Bronze



Dark Bronze

# Your Logo 3" Deep Aluminum with Back

**PRICE PER LOGO.** Including standard mounting with pattern.

*Logos smaller than 10" x 10" or with more than 3 pieces email for quote*

Size	37"*	38"*	39"*	40"*	41"*	42"*	43"*	44"*	45"*	46"*	47"*	48"	49"*	50"	52"*	54"	56"*	58"	60"*
16"	\$588.56	\$604.47	\$620.37	\$636.28	\$652.19	\$668.09	\$684.00	\$699.91	\$715.81	\$731.72	\$747.63	\$763.53	\$779.44	\$795.35	\$827.16	\$858.98	\$890.79	\$922.60	\$954.42
17	625.34	642.25	659.15	676.05	692.95	709.85	726.75	743.65	760.55	777.45	794.35	811.26	828.16	845.06	878.86	912.66	946.46	980.27	1,014.07
18	662.13	680.02	697.92	715.81	733.71	751.60	769.50	787.40	805.29	823.19	841.08	858.98	876.87	894.77	930.56	966.35	1,002.14	1,037.93	1,073.72
19	698.91	717.80	736.69	755.58	774.47	793.36	812.25	831.14	850.03	868.92	887.81	906.70	925.59	944.48	982.25	1,020.03	1,057.81	1,095.59	1,133.37
20	735.70	755.58	775.47	795.35	815.23	835.12	855.00	874.88	894.77	914.65	934.53	954.42	974.30	994.18	1,033.95	1,073.72	1,113.49	1,153.25	1,193.02
21	772.48	793.36	814.24	835.12	855.99	876.87	897.75	918.63	939.50	960.38	981.26	1,002.14	1,023.02	1,043.89	1,085.65	1,127.40	1,169.16	1,210.92	1,252.67
22	809.27	831.14	853.01	874.88	896.76	918.63	940.50	962.37	984.24	1,006.11	1,027.99	1,049.86	1,071.73	1,093.60	1,137.35	1,181.09	1,224.83	1,268.58	1,312.32
23	846.05	868.92	891.78	914.65	937.52	960.38	983.25	1,006.11	1,028.98	1,051.85	1,074.71	1,097.58	1,120.45	1,143.31	1,189.04	1,234.78	1,280.51	1,326.24	1,371.97
24	882.84	906.70	930.56	954.42	978.28	1,002.14	1,026.00	1,049.86	1,073.72	1,097.58	1,121.44	1,145.30	1,169.16	1,193.02	1,240.74	1,288.46	1,336.18	1,383.90	1,431.62
25	919.62	944.48	969.33	994.18	1,019.04	1,043.89	1,068.75	1,093.60	1,118.46	1,143.31	1,168.17	1,193.02	1,217.88	1,242.73	1,292.44	1,342.15	1,391.86	1,441.57	1,491.27
26	956.41	982.25	1,008.10	1,033.95	1,059.80	1,085.65	1,111.50	1,137.35	1,163.20	1,189.04	1,214.89	1,240.74	1,266.59	1,292.44	1,344.14	1,395.83	1,447.53	1,499.23	1,550.93
27	993.19	1,020.03	1,046.88	1,073.72	1,100.56	1,127.40	1,154.25	1,181.09	1,207.93	1,234.78	1,261.62	1,288.46	1,315.30	1,342.15	1,395.83	1,449.52	1,503.20	1,556.89	1,610.58
28	1,029.98	1,057.81	1,085.65	1,113.49	1,141.32	1,169.16	1,197.00	1,224.83	1,252.67	1,280.51	1,308.35	1,336.18	1,364.02	1,391.86	1,447.53	1,503.20	1,558.88	1,614.55	1,670.23
29	1,066.76	1,095.59	1,124.42	1,153.25	1,182.08	1,210.92	1,239.75	1,268.58	1,297.41	1,326.24	1,355.07	1,383.90	1,412.73	1,441.57	1,499.23	1,556.89	1,614.55	1,672.22	1,729.88
30*	1,103.54	1,133.37	1,163.20	1,193.02	1,222.85	1,252.67	1,282.50	1,312.32	1,342.15	1,371.97	1,401.80	1,431.62	1,461.45	1,491.27	1,550.93	1,610.58	1,670.23	1,729.88	1,789.53
31*	1,140.33	1,171.15	1,201.97	1,232.79	1,263.61	1,294.43	1,325.25	1,356.07	1,386.89	1,417.71	1,448.52	1,479.34	1,510.16	1,540.98	1,602.62	1,664.26	1,725.90	1,787.54	1,849.18
32*	1,177.11	1,208.93	1,240.74	1,272.55	1,304.37	1,336.18	1,368.00	1,399.81	1,431.62	1,463.44	1,495.25	1,527.06	1,558.88	1,590.69	1,654.32	1,717.95	1,781.57	1,845.20	1,908.83
33*	1,213.90	1,246.71	1,279.51	1,312.32	1,345.13	1,377.94	1,410.75	1,443.55	1,476.36	1,509.17	1,541.98	1,574.79	1,607.59	1,640.40	1,706.02	1,771.63	1,837.25	1,902.86	1,968.48
34*	1,250.68	1,284.49	1,318.29	1,352.09	1,385.89	1,419.69	1,453.50	1,487.30	1,521.10	1,554.90	1,588.70	1,622.51	1,656.31	1,690.11	1,757.71	1,825.32	1,892.92	1,960.53	2,028.13
35*	1,287.47	1,322.26	1,357.06	1,391.86	1,426.65	1,461.45	1,496.25	1,531.04	1,565.84	1,600.63	1,635.43	1,670.23	1,705.02	1,739.82	1,809.41	1,879.00	1,948.60	2,018.19	2,087.78
36*	1,324.25	1,360.04	1,395.83	1,431.62	1,467.41	1,503.20	1,539.00	1,574.79	1,610.58	1,646.37	1,682.16	1,717.95	1,753.74	1,789.53	1,861.11	1,932.69	2,004.27	2,075.85	2,147.43
38*	1,397.82	1,435.60	1,473.38	1,511.16	1,548.94	1,586.72	1,624.49	1,662.27	1,700.05	1,737.83	1,775.61	1,813.39	1,851.17	1,888.95	1,964.50	2,040.06	2,115.62	2,191.18	2,266.73
40*	1,471.39	1,511.16	1,550.93	1,590.69	1,630.46	1,670.23	1,709.99	1,749.76	1,789.53	1,829.30	1,869.06	1,908.83	1,948.60	1,988.36	2,067.90	2,147.43	2,226.97	2,306.50	2,386.04
42*	1,544.96	1,586.72	1,628.47	1,670.23	1,711.98	1,753.74	1,795.49	1,837.25	1,879.00	1,920.76	1,962.52	2,004.27	2,046.03	2,087.78	2,171.29	2,254.80	2,338.32	2,421.83	2,505.34
44*	1,618.53	1,662.27	1,706.02	1,749.76	1,793.51	1,837.25	1,880.99	1,924.74	1,968.48	2,012.22	2,055.97	2,099.71	2,143.46	2,187.20	2,274.69	2,362.18	2,449.66	2,537.15	2,624.64
46*	1,692.10	1,737.83	1,783.56	1,829.30	1,875.03	1,920.76	1,966.49	2,012.22	2,057.96	2,103.69	2,149.42	2,195.15	2,240.89	2,286.62	2,378.08	2,469.55	2,561.01	2,652.48	2,743.94
48*	1,765.67	1,813.39	1,861.11	1,908.83	1,956.55	2,004.27	2,051.99	2,099.71	2,147.43	2,195.15	2,242.87	2,290.59	2,338.32	2,386.04	2,481.48	2,576.92	2,672.36	2,767.80	2,863.24
50*	1,839.24	1,888.95	1,938.66	1,988.36	2,038.07	2,087.78	2,137.49	2,187.20	2,236.91	2,286.62	2,336.33	2,386.04	2,435.75	2,485.45	2,584.87	2,684.29	2,783.71	2,883.13	2,982.54
52*	1,912.81	1,964.50	2,016.20	2,067.90	2,119.60	2,171.29	2,222.99	2,274.69	2,326.39	2,378.08	2,429.78	2,481.48	2,533.17	2,584.87	2,688.27	2,791.66	2,895.06	2,998.45	3,101.85
54*	1,986.38	2,040.06	2,093.75	2,147.43	2,201.12	2,254.80	2,308.49	2,362.18	2,415.86	2,469.55	2,523.23	2,576.92	2,630.60	2,684.29	2,791.66	2,899.03	3,006.40	3,113.78	3,221.15
56*	2,059.95	2,115.62	2,171.29	2,226.97	2,282.64	2,338.32	2,393.99	2,449.66	2,505.34	2,561.01	2,616.69	2,672.36	2,728.03	2,783.71	2,895.06	3,006.40	3,117.75	3,229.10	3,340.45
58*	2,133.51	2,191.18	2,248.84	2,306.50	2,364.16	2,421.83	2,479.49	2,537.15	2,594.81	2,652.48	2,710.14	2,767.80	2,825.46	2,883.13	2,998.45	3,113.78	3,229.10	3,344.43	3,459.75
60*	2,207.08	2,266.73	2,326.39	2,386.04	2,445.69	2,505.34	2,564.99	2,624.64	2,684.29	2,743.94	2,803.59	2,863.24	2,922.89	2,982.54	3,101.85	3,221.15	3,340.45	3,459.75	3,579.05
61+	EMAIL FOR QUOTE																		

\*Oversize charges will apply

**PRICE AS LISTED**



Brushed

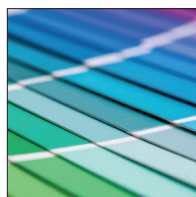

Painted

**OPTIONAL ANODIZED FINISHES - EMAIL FOR QUOTE**



Clear

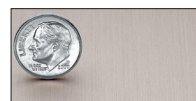

Champagne



Gold

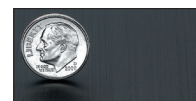

Black



Light Bronze



Medium Bronze



Dark Bronze



# Your Logo 3-1/2" Deep Aluminum without Back

**PRICE PER LOGO.** Including standard mounting with pattern.

*Logos smaller than 10" x 10" or with more than 3 pieces email for quote*

Size	16"	17"	18"	19"	20"	21"	22"	23"	24"	25"	26**	27"	28**	29"	30**	31"	32**	33"	34**	35"	36**
16"	\$242.99	\$258.18	\$273.37	\$288.56	\$303.74	\$318.93	\$334.12	\$349.30	\$364.49	\$379.68	\$394.86	\$410.05	\$425.24	\$440.42	\$455.61	\$470.80	\$485.98	\$501.17	\$516.36	\$531.55	\$546.73
17	258.18	274.32	290.45	306.59	322.73	338.86	355.00	371.13	387.27	403.41	419.54	435.68	451.81	467.95	484.09	500.22	516.36	532.49	548.63	564.77	580.90
18	273.37	290.45	307.54	324.62	341.71	358.79	375.88	392.97	410.05	427.14	444.22	461.31	478.39	495.48	512.56	529.65	546.73	563.82	580.90	597.99	615.07
19	288.56	306.59	324.62	342.66	360.69	378.73	396.76	414.80	432.83	450.87	468.90	486.93	504.97	523.00	541.04	559.07	577.11	595.14	613.18	631.21	649.24
20	303.74	322.73	341.71	360.69	379.68	398.66	417.64	436.63	455.61	474.59	493.58	512.56	531.55	550.53	569.51	588.50	607.48	626.46	645.45	664.43	683.41
21	318.93	338.86	358.79	378.73	398.66	418.59	438.53	458.46	478.39	498.32	518.26	538.19	558.12	578.06	597.99	617.92	637.85	657.79	677.72	697.65	717.58
22	334.12	355.00	375.88	396.76	417.64	438.53	459.41	480.29	501.17	522.05	542.94	563.82	584.70	605.58	626.46	647.35	668.23	689.11	709.99	730.87	751.76
23	349.30	371.13	392.97	414.80	436.63	458.46	480.29	502.12	523.95	545.78	567.61	589.45	611.28	633.11	654.94	676.77	698.60	720.43	742.26	764.09	785.93
24	364.49	387.27	410.05	432.83	455.61	478.39	501.17	523.95	546.73	569.51	592.29	615.07	637.85	660.63	683.41	706.19	728.97	751.76	774.54	797.32	820.10
25	379.68	403.41	427.14	450.87	474.59	498.32	522.05	545.78	569.51	593.24	616.97	640.70	664.43	688.16	711.89	735.62	759.35	783.08	806.81	830.54	854.27
26	394.86	419.54	444.22	468.90	493.58	518.26	542.94	567.61	592.29	616.97	641.65	666.33	691.01	715.69	740.37	765.04	789.72	814.40	839.08	863.76	888.44
27	410.05	435.68	461.31	486.93	512.56	538.19	563.82	589.45	615.07	640.70	666.33	691.96	717.58	743.21	768.84	794.47	820.10	845.72	871.35	896.98	922.61
28	425.24	451.81	478.39	504.97	531.55	558.12	584.70	611.28	637.85	664.43	691.01	717.58	744.16	770.74	797.32	823.89	850.47	877.05	903.62	930.20	956.78
29	440.42	467.95	495.48	523.00	550.53	578.06	605.58	633.11	660.63	688.16	715.69	743.21	770.74	798.27	825.79	853.32	880.84	908.37	935.90	963.42	990.95
30*	455.61	484.09	512.56	541.04	569.51	597.99	626.46	654.94	683.41	711.89	740.37	768.84	797.32	825.79	854.27	882.74	911.22	939.69	968.17	996.64	1,025.12
31*	470.80	500.22	529.65	559.07	588.50	617.92	647.35	676.77	706.19	735.62	765.04	794.47	823.89	853.32	882.74	912.17	941.59	971.02	1,000.44	1,029.86	1,059.29
32*	485.98	516.36	546.73	577.11	607.48	637.85	668.23	698.60	728.97	759.35	789.72	820.10	850.47	880.84	911.22	941.59	971.96	1,002.34	1,032.71	1,063.09	1,093.46
33*	501.17	532.49	563.82	595.14	626.46	657.79	689.11	720.43	751.76	783.08	814.40	845.72	877.05	908.37	939.69	971.02	1,002.34	1,033.66	1,064.98	1,096.31	1,127.63
34*	516.36	548.63	580.90	613.18	645.45	677.72	709.99	742.26	774.54	806.81	839.08	871.35	903.62	935.90	968.17	1,000.44	1,032.71	1,064.98	1,097.26	1,129.53	1,161.80
35*	531.55	564.77	597.99	631.21	664.43	697.65	730.87	764.09	797.32	830.54	863.76	896.98	930.20	963.42	996.64	1,029.86	1,063.09	1,096.31	1,129.53	1,162.75	1,195.97
36*	546.73	580.90	615.07	649.24	683.41	717.58	751.76	785.93	820.10	854.27	888.44	922.61	956.78	990.95	1,025.12	1,059.29	1,093.46	1,127.63	1,161.80	1,195.97	1,230.14
38*	577.11	613.18	649.24	685.31	721.38	757.45	793.52	829.59	865.66	901.73	937.79	973.86	1,009.93	1,046.00	1,082.07	1,118.14	1,154.21	1,190.28	1,226.35	1,262.41	1,298.48
40*	607.48	645.45	683.41	721.38	759.35	797.32	835.28	873.25	911.22	949.18	987.15	1,025.12	1,063.09	1,101.05	1,139.02	1,176.99	1,214.95	1,252.92	1,290.89	1,328.86	1,366.82
42*	637.85	677.72	717.58	757.45	797.32	837.18	877.05	916.91	956.78	996.64	1,036.51	1,076.37	1,116.24	1,156.11	1,195.97	1,235.84	1,275.70	1,315.57	1,355.43	1,395.30	1,435.16
44*	668.23	709.99	751.76	793.52	835.28	877.05	918.81	960.57	1,002.34	1,044.10	1,085.87	1,127.63	1,169.39	1,211.16	1,252.92	1,294.69	1,336.45	1,378.21	1,419.98	1,461.74	1,503.51
46*	698.60	742.26	785.93	829.59	873.25	916.91	960.57	1,004.24	1,047.90	1,091.56	1,135.22	1,178.89	1,222.55	1,266.21	1,309.87	1,353.54	1,397.20	1,440.86	1,484.52	1,528.18	1,571.85
48*	728.97	774.54	820.10	865.66	911.22	956.78	1,002.34	1,047.90	1,093.46	1,139.02	1,184.58	1,230.14	1,275.70	1,321.26	1,366.82	1,412.38	1,457.94	1,503.51	1,549.07	1,594.63	1,640.19
50*	759.35	806.81	854.27	901.73	949.18	996.64	1,044.10	1,091.56	1,139.02	1,186.48	1,233.94	1,281.40	1,328.86	1,376.32	1,423.77	1,471.23	1,518.69	1,566.15	1,613.61	1,661.07	1,708.53
52*	789.72	839.08	888.44	937.79	987.15	1,036.51	1,085.87	1,135.22	1,184.58	1,233.94	1,283.30	1,332.65	1,382.01	1,431.37	1,480.73	1,530.08	1,579.44	1,628.80	1,678.15	1,727.51	1,776.87
54*	820.10	871.35	922.61	973.86	1,025.12	1,076.37	1,127.63	1,178.89	1,230.14	1,281.40	1,332.65	1,383.91	1,435.16	1,486.42	1,537.68	1,588.93	1,640.19	1,691.44	1,742.70	1,793.95	1,845.21
56*	850.47	903.62	956.78	1,009.93	1,063.09	1,116.24	1,169.39	1,222.55	1,275.70	1,328.86	1,382.01	1,435.16	1,488.32	1,541.47	1,594.63	1,647.78	1,700.93	1,754.09	1,807.24	1,860.40	1,913.55
58*	880.84	935.90	990.95	1,046.00	1,101.05	1,156.11	1,211.16	1,266.21	1,321.26	1,376.32	1,431.37	1,486.42	1,541.47	1,596.53	1,651.58	1,706.63	1,761.68	1,816.73	1,871.79	1,926.84	1,981.89
60*	911.22	968.17	1,025.12	1,082.07	1,139.02	1,195.97	1,252.92	1,309.87	1,366.82	1,423.77	1,480.73	1,537.68	1,594.63	1,651.58	1,708.53	1,765.48	1,822.43	1,879.38	1,936.33	1,993.28	2,050.23
61+	EMAIL FOR QUOTE																				

\*Oversize charges will apply

## PRICE AS LISTED

## OPTIONAL ANODIZED FINISHES - EMAIL FOR QUOTE



Brushed

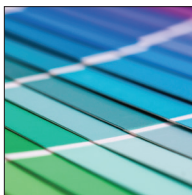

Painted



Clear



Champagne



Gold



Black



Light Bronze

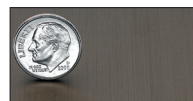

Medium Bronze



Dark Bronze

# Your Logo 3-1/2" Deep Aluminum without Back

**PRICE PER LOGO.** Including standard mounting with pattern.

*Logos smaller than 10" x 10" or with more than 3 pieces email for quote*

Size	37"*	38"*	39"*	40"*	41"*	42"*	43"*	44"*	45"*	46"*	47"*	48"	49"*	50"	52"*	54"	56"*	58"	60"*
16"	\$561.92	\$577.11	\$592.29	\$607.48	\$622.67	\$637.85	\$653.04	\$668.23	\$683.41	\$698.60	\$713.79	\$728.97	\$744.16	\$759.35	\$789.72	\$820.10	\$850.47	\$880.84	\$911.22
17	597.04	613.18	629.31	645.45	661.58	677.72	693.86	709.99	726.13	742.26	758.40	774.54	790.67	806.81	839.08	871.35	903.62	935.90	968.17
18	632.16	649.24	666.33	683.41	700.50	717.58	734.67	751.76	768.84	785.93	803.01	820.10	837.18	854.27	888.44	922.61	956.78	990.95	1,025.12
19	667.28	685.31	703.35	721.38	739.42	757.45	775.48	793.52	811.55	829.59	847.62	865.66	883.69	901.73	937.79	973.86	1,009.93	1,046.00	1,082.07
20	702.40	721.38	740.37	759.35	778.33	797.32	816.30	835.28	854.27	873.25	892.23	911.22	930.20	949.18	987.15	1,025.12	1,063.09	1,101.05	1,139.02
21	737.52	757.45	777.38	797.32	817.25	837.18	857.11	877.05	896.98	916.91	936.85	956.78	976.71	996.64	1,036.51	1,076.37	1,116.24	1,156.11	1,195.97
22	772.64	793.52	814.40	835.28	856.17	877.05	897.93	918.81	939.69	960.57	981.46	1,002.34	1,023.22	1,044.10	1,085.87	1,127.63	1,169.39	1,211.16	1,252.92
23	807.76	829.59	851.42	873.25	895.08	916.91	938.74	960.57	982.41	1,004.24	1,026.07	1,047.90	1,069.73	1,091.56	1,135.22	1,178.89	1,222.55	1,266.21	1,309.87
24	842.88	865.66	888.44	911.22	934.00	956.78	979.56	1,002.34	1,025.12	1,047.90	1,070.68	1,093.46	1,116.24	1,139.02	1,184.58	1,230.14	1,275.70	1,321.26	1,366.82
25	878.00	901.73	925.46	949.18	972.91	996.64	1,020.37	1,044.10	1,067.83	1,091.56	1,115.29	1,139.02	1,162.75	1,186.48	1,233.94	1,281.40	1,328.86	1,376.32	1,423.77
26	913.12	937.79	962.47	987.15	1,011.83	1,036.51	1,061.19	1,085.87	1,110.55	1,135.22	1,159.90	1,184.58	1,209.26	1,233.94	1,283.30	1,332.65	1,382.01	1,431.37	1,480.73
27	948.24	973.86	999.49	1,025.12	1,050.75	1,076.37	1,102.00	1,127.63	1,153.26	1,178.89	1,204.51	1,230.14	1,255.77	1,281.40	1,332.65	1,383.91	1,435.16	1,486.42	1,537.68
28	983.36	1,009.93	1,036.51	1,063.09	1,089.66	1,116.24	1,142.82	1,169.39	1,195.97	1,222.55	1,249.13	1,275.70	1,302.28	1,328.86	1,382.01	1,435.16	1,488.32	1,541.47	1,594.63
29	1,018.47	1,046.00	1,073.53	1,101.05	1,128.58	1,156.11	1,183.63	1,211.16	1,238.68	1,266.21	1,293.74	1,321.26	1,348.79	1,376.32	1,431.37	1,486.42	1,541.47	1,596.53	1,651.58
30*	1,053.59	1,082.07	1,110.55	1,139.02	1,167.50	1,195.97	1,224.45	1,252.92	1,281.40	1,309.87	1,338.35	1,366.82	1,395.30	1,423.77	1,480.73	1,537.68	1,594.63	1,651.58	1,708.53
31*	1,088.71	1,118.14	1,147.56	1,176.99	1,206.41	1,235.84	1,265.26	1,294.69	1,324.11	1,353.54	1,382.96	1,412.38	1,441.81	1,471.23	1,530.08	1,588.93	1,647.78	1,706.63	1,765.48
32*	1,123.83	1,154.21	1,184.58	1,214.95	1,245.33	1,275.70	1,306.08	1,336.45	1,366.82	1,397.20	1,427.57	1,457.94	1,488.32	1,518.69	1,579.44	1,640.19	1,700.93	1,761.68	1,822.43
33*	1,158.95	1,190.28	1,221.60	1,252.92	1,284.25	1,315.57	1,346.89	1,378.21	1,409.54	1,440.86	1,472.18	1,503.51	1,534.83	1,566.15	1,628.80	1,691.44	1,754.09	1,816.73	1,879.38
34*	1,194.07	1,226.35	1,258.62	1,290.89	1,323.16	1,355.43	1,387.71	1,419.98	1,452.25	1,484.52	1,516.79	1,549.07	1,581.34	1,613.61	1,678.15	1,742.70	1,807.24	1,871.79	1,936.33
35*	1,229.19	1,262.41	1,295.64	1,328.86	1,362.08	1,395.30	1,428.52	1,461.74	1,494.96	1,528.18	1,561.41	1,594.63	1,627.85	1,661.07	1,727.51	1,793.95	1,860.40	1,926.84	1,993.28
36*	1,264.31	1,298.48	1,332.65	1,366.82	1,400.99	1,435.16	1,469.34	1,503.51	1,537.68	1,571.85	1,606.02	1,640.19	1,674.36	1,708.53	1,776.87	1,845.21	1,913.55	1,981.89	2,050.23
38*	1,334.55	1,370.62	1,406.69	1,442.76	1,478.83	1,514.90	1,550.96	1,587.03	1,623.10	1,659.17	1,695.24	1,731.31	1,767.38	1,803.45	1,875.58	1,947.72	2,019.86	2,092.00	2,164.13
40*	1,404.79	1,442.76	1,480.73	1,518.69	1,556.66	1,594.63	1,632.59	1,670.56	1,708.53	1,746.50	1,784.46	1,822.43	1,860.40	1,898.36	1,974.30	2,050.23	2,126.17	2,202.10	2,278.04
42*	1,475.03	1,514.90	1,554.76	1,594.63	1,634.49	1,674.36	1,714.22	1,754.09	1,793.95	1,833.82	1,873.69	1,913.55	1,953.42	1,993.28	2,073.01	2,152.74	2,232.48	2,312.21	2,391.94
44*	1,545.27	1,587.03	1,628.80	1,670.56	1,712.33	1,754.09	1,795.85	1,837.62	1,879.38	1,921.14	1,962.91	2,004.67	2,046.44	2,088.20	2,171.73	2,255.26	2,338.78	2,422.31	2,505.84
46*	1,615.51	1,659.17	1,702.83	1,746.50	1,790.16	1,833.82	1,877.48	1,921.14	1,964.81	2,008.47	2,052.13	2,095.79	2,139.46	2,183.12	2,270.44	2,357.77	2,445.09	2,532.42	2,619.74
48*	1,685.75	1,731.31	1,776.87	1,822.43	1,867.99	1,913.55	1,959.11	2,004.67	2,050.23	2,095.79	2,141.35	2,186.91	2,232.48	2,278.04	2,369.16	2,460.28	2,551.40	2,642.52	2,733.64
50*	1,755.99	1,803.45	1,850.91	1,898.36	1,945.82	1,993.28	2,040.74	2,088.20	2,135.66	2,183.12	2,230.58	2,278.04	2,325.50	2,372.95	2,467.87	2,562.79	2,657.71	2,752.63	2,847.54
52*	1,826.23	1,875.58	1,924.94	1,974.30	2,023.66	2,073.01	2,122.37	2,171.73	2,221.09	2,270.44	2,319.80	2,369.16	2,418.51	2,467.87	2,566.59	2,665.30	2,764.02	2,862.73	2,961.45
54*	1,896.47	1,947.72	1,998.98	2,050.23	2,101.49	2,152.74	2,204.00	2,255.26	2,306.51	2,357.77	2,409.02	2,460.28	2,511.53	2,562.79	2,665.30	2,767.81	2,870.32	2,972.84	3,075.35
56*	1,966.71	2,019.86	2,073.01	2,126.17	2,179.32	2,232.48	2,285.63	2,338.78	2,391.94	2,445.09	2,498.25	2,551.40	2,604.55	2,657.71	2,764.02	2,870.32	2,976.63	3,082.94	3,189.25
58*	2,036.94	2,092.00	2,147.05	2,202.10	2,257.15	2,312.21	2,367.26	2,422.31	2,477.36	2,532.42	2,587.47	2,642.52	2,697.57	2,752.63	2,862.73	2,972.84	3,082.94	3,193.05	3,303.15
60*	2,107.18	2,164.13	2,221.09	2,278.04	2,334.99	2,391.94	2,448.89	2,505.84	2,562.79	2,619.74	2,676.69	2,733.64	2,790.59	2,847.54	2,961.45	3,075.35	3,189.25	3,303.15	3,417.05
61+	EMAIL FOR QUOTE																		

\*Oversize charges will apply

## PRICE AS LISTED



Brushed

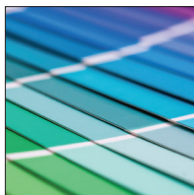

Painted

## OPTIONAL ANODIZED FINISHES - EMAIL FOR QUOTE



Clear



Champagne

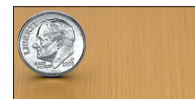

Gold



Black



Light Bronze

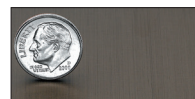

Medium Bronze



Dark Bronze

# Your Logo 3-1/2" Deep Aluminum with Back

PRICE PER LOGO. Including standard mounting with pattern.

Logos smaller than 10" x 10" or with more than 3 pieces email for quote

Size	16"	17"	18"	19"	20"	21"	22"	23"	24"	25"	26"*	27"	28"*	29"	30"*	31"	32"*	33"	34"*	35"	36"*
16"	\$277.45	\$294.80	\$312.14	\$329.48	\$346.82	\$364.16	\$381.50	\$398.84	\$416.18	\$433.52	\$450.86	\$468.20	\$485.54	\$502.88	\$520.22	\$537.56	\$554.90	\$572.25	\$589.59	\$606.93	\$624.27
17	294.80	313.22	331.64	350.07	368.49	386.92	405.34	423.77	442.19	460.62	479.04	497.46	515.89	534.31	552.74	571.16	589.59	608.01	626.44	644.86	663.28
18	312.14	331.64	351.15	370.66	390.17	409.68	429.19	448.69	468.20	487.71	507.22	526.73	546.23	565.74	585.25	604.76	624.27	643.78	663.28	682.79	702.30
19	329.48	350.07	370.66	391.25	411.84	432.44	453.03	473.62	494.21	514.80	535.40	555.99	576.58	597.17	617.76	638.36	658.95	679.54	700.13	720.72	741.32
20	346.82	368.49	390.17	411.84	433.52	455.20	476.87	498.55	520.22	541.90	563.58	585.25	606.93	628.60	650.28	671.95	693.63	715.31	736.98	758.66	780.33
21	364.16	386.92	409.68	432.44	455.20	477.96	500.72	523.48	546.23	568.99	591.75	614.51	637.27	660.03	682.79	705.55	728.31	751.07	773.83	796.59	819.35
22	381.50	405.34	429.19	453.03	476.87	500.72	524.56	548.40	572.25	596.09	619.93	643.78	667.62	691.46	715.31	739.15	762.99	786.84	810.68	834.52	858.37
23	398.84	423.77	448.69	473.62	498.55	523.48	548.40	573.33	598.26	623.18	648.11	673.04	697.97	722.89	747.82	772.75	797.67	822.60	847.53	872.46	897.38
24	416.18	442.19	468.20	494.21	520.22	546.23	572.25	598.26	624.27	650.28	676.29	702.30	728.31	754.32	780.33	806.34	832.35	858.37	884.38	910.39	936.40
25	433.52	460.62	487.71	514.80	541.90	568.99	596.09	623.18	650.28	677.37	704.47	731.56	758.66	785.75	812.85	839.94	867.04	894.13	921.23	948.32	975.42
26	450.86	479.04	507.22	535.40	563.58	591.75	619.93	648.11	676.29	704.47	732.65	760.82	789.00	817.18	845.36	873.54	901.72	929.90	958.07	986.25	1,014.43
27	468.20	497.46	526.73	555.99	585.25	614.51	643.78	673.04	702.30	731.56	760.82	790.09	819.35	848.61	877.87	907.14	936.40	965.66	994.92	1,024.19	1,053.45
28	485.54	515.89	546.23	576.58	606.93	637.27	667.62	697.97	728.31	758.66	789.00	819.35	849.70	880.04	910.39	940.73	971.08	1,001.43	1,031.77	1,062.12	1,092.46
29	502.88	534.31	565.74	597.17	628.60	660.03	691.46	722.89	754.32	785.75	817.18	848.61	880.04	911.47	942.90	974.33	1,005.76	1,037.19	1,068.62	1,100.05	1,131.48
30*	520.22	552.74	585.25	617.76	650.28	682.79	715.31	747.82	780.33	812.85	845.36	877.87	910.39	942.90	975.42	1,007.93	1,040.44	1,072.96	1,105.47	1,137.98	1,170.50
31*	537.56	571.16	604.76	638.36	671.95	705.55	739.15	772.75	806.34	839.94	873.54	907.14	940.73	974.33	1,007.93	1,041.53	1,075.12	1,108.72	1,142.32	1,175.92	1,209.51
32*	554.90	589.59	624.27	658.95	693.63	728.31	762.99	797.67	832.35	867.04	901.72	936.40	971.08	1,005.76	1,040.44	1,075.12	1,109.80	1,144.49	1,179.17	1,213.85	1,248.53
33*	572.25	608.01	643.78	679.54	715.31	751.07	786.84	822.60	858.37	894.13	929.90	965.66	1,001.43	1,037.19	1,072.96	1,108.72	1,144.49	1,180.25	1,216.02	1,251.78	1,287.55
34*	589.59	626.44	663.28	700.13	736.98	773.83	810.68	847.53	884.38	921.23	958.07	994.92	1,031.77	1,068.62	1,105.47	1,142.32	1,179.17	1,216.02	1,252.87	1,289.71	1,326.56
35*	606.93	644.86	682.79	720.72	758.66	796.59	834.52	872.46	910.39	948.32	986.25	1,024.19	1,062.12	1,100.05	1,137.98	1,175.92	1,213.85	1,251.78	1,289.71	1,327.65	1,365.58
36*	624.27	663.28	702.30	741.32	780.33	819.35	858.37	897.38	936.40	975.42	1,014.43	1,053.45	1,092.46	1,131.48	1,170.50	1,209.51	1,248.53	1,287.55	1,326.56	1,365.58	1,404.60
38*	658.95	700.13	741.32	782.50	823.68	864.87	906.05	947.24	988.42	1,029.60	1,070.79	1,111.97	1,153.16	1,194.34	1,235.52	1,276.71	1,317.89	1,359.08	1,400.26	1,441.44	1,482.63
40*	693.63	736.98	780.33	823.68	867.04	910.39	953.74	997.09	1,040.44	1,083.79	1,127.15	1,170.50	1,213.85	1,257.20	1,300.55	1,343.90	1,387.25	1,430.61	1,473.96	1,517.31	1,560.66
42*	728.31	773.83	819.35	864.87	910.39	955.91	1,001.43	1,046.95	1,092.46	1,137.98	1,183.50	1,229.02	1,274.54	1,320.06	1,365.58	1,411.10	1,456.62	1,502.14	1,547.66	1,593.17	1,638.69
44*	762.99	810.68	858.37	906.05	953.74	1,001.43	1,049.11	1,096.80	1,144.49	1,192.17	1,239.86	1,287.55	1,335.23	1,382.92	1,430.61	1,478.29	1,525.98	1,573.67	1,621.35	1,669.04	1,716.73
46*	797.67	847.53	897.38	947.24	997.09	1,046.95	1,096.80	1,146.65	1,196.51	1,246.36	1,296.22	1,346.07	1,395.93	1,445.78	1,495.63	1,545.49	1,595.34	1,645.20	1,695.05	1,744.91	1,794.76
48*	832.35	884.38	936.40	988.42	1,040.44	1,092.46	1,144.49	1,196.51	1,248.53	1,300.55	1,352.57	1,404.60	1,456.62	1,508.64	1,560.66	1,612.68	1,664.70	1,716.73	1,768.75	1,820.77	1,872.79
50*	867.04	921.23	975.42	1,029.60	1,083.79	1,137.98	1,192.17	1,246.36	1,300.55	1,354.74	1,408.93	1,463.12	1,517.31	1,571.50	1,625.69	1,679.88	1,734.07	1,788.26	1,842.45	1,896.64	1,950.83
52*	901.72	958.07	1,014.43	1,070.79	1,127.15	1,183.50	1,239.86	1,296.22	1,352.57	1,408.93	1,465.29	1,521.64	1,578.00	1,634.36	1,690.72	1,747.07	1,803.43	1,859.79	1,916.14	1,972.50	2,028.86
54*	936.40	994.92	1,053.45	1,111.97	1,170.50	1,229.02	1,287.55	1,346.07	1,404.60	1,463.12	1,521.64	1,580.17	1,638.69	1,697.22	1,755.74	1,814.27	1,872.79	1,931.32	1,989.84	2,048.37	2,106.89
56*	971.08	1,031.77	1,092.46	1,153.16	1,213.85	1,274.54	1,335.23	1,395.93	1,456.62	1,517.31	1,578.00	1,638.69	1,699.39	1,760.08	1,820.77	1,881.46	1,942.15	2,002.85	2,063.54	2,124.23	2,184.92
58*	1,005.76	1,068.62	1,131.48	1,194.34	1,257.20	1,320.06	1,382.92	1,445.78	1,508.64	1,571.50	1,634.36	1,697.22	1,760.08	1,822.94	1,885.80	1,948.66	2,011.52	2,074.38	2,137.24	2,200.10	2,262.96
60*	1,040.44	1,105.47	1,170.50	1,235.52	1,300.55	1,365.58	1,430.61	1,495.63	1,560.66	1,625.69	1,690.72	1,755.74	1,820.77	1,885.80	1,950.83	2,015.85	2,080.88	2,145.91	2,210.93	2,275.96	2,340.99
61+	EMAIL FOR QUOTE																				

\*Oversize charges will apply

## PRICE AS LISTED



Brushed

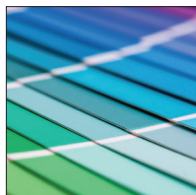

Painted

## OPTIONAL ANODIZED FINISHES - EMAIL FOR QUOTE



Clear



Champagne



Gold



Black



Light Bronze



Medium Bronze



Dark Bronze



# Your Logo 3-1/2" Deep Aluminum with Back

**PRICE PER LOGO.** Including standard mounting with pattern.

*Logos smaller than 10" x 10" or with more than 3 pieces email for quote*

Size	37"*	38"*	39"*	40"*	41"*	42"*	43"*	44"*	45"*	46"*	47"*	48"	49"*	50"	52"*	54"	56"*	58"	60"*
16"	\$641.61	\$658.95	\$676.29	\$693.63	\$710.97	\$728.31	\$745.65	\$762.99	\$780.33	\$797.67	\$815.01	\$832.35	\$849.70	\$867.04	\$901.72	\$936.40	\$971.08	\$1,005.76	\$1,040.44
17	681.71	700.13	718.56	736.98	755.41	773.83	792.25	810.68	829.10	847.53	865.95	884.38	902.80	921.23	958.07	994.92	1,031.77	1,068.62	1,105.47
18	721.81	741.32	760.82	780.33	799.84	819.35	838.86	858.37	877.87	897.38	916.89	936.40	955.91	975.42	1,014.43	1,053.45	1,092.46	1,131.48	1,170.50
19	761.91	782.50	803.09	823.68	844.28	864.87	885.46	906.05	926.64	947.24	967.83	988.42	1,009.01	1,029.60	1,070.79	1,111.97	1,153.16	1,194.34	1,235.52
20	802.01	823.68	845.36	867.04	888.71	910.39	932.06	953.74	975.42	997.09	1,018.77	1,040.44	1,062.12	1,083.79	1,127.15	1,170.50	1,213.85	1,257.20	1,300.55
21	842.11	864.87	887.63	910.39	933.15	955.91	978.67	1,001.43	1,024.19	1,046.95	1,069.70	1,092.46	1,115.22	1,137.98	1,183.50	1,229.02	1,274.54	1,320.06	1,365.58
22	882.21	906.05	929.90	953.74	977.58	1,001.43	1,025.27	1,049.11	1,072.96	1,096.80	1,120.64	1,144.49	1,168.33	1,192.17	1,239.86	1,287.55	1,335.23	1,382.92	1,430.61
23	922.31	947.24	972.16	997.09	1,022.02	1,046.95	1,071.87	1,096.80	1,121.73	1,146.65	1,171.58	1,196.51	1,221.44	1,246.36	1,296.22	1,346.07	1,395.93	1,445.78	1,495.63
24	962.41	988.42	1,014.43	1,040.44	1,066.45	1,092.46	1,118.48	1,144.49	1,170.50	1,196.51	1,222.52	1,248.53	1,274.54	1,300.55	1,352.57	1,404.60	1,456.62	1,508.64	1,560.66
25	1,002.51	1,029.60	1,056.70	1,083.79	1,110.89	1,137.98	1,165.08	1,192.17	1,219.27	1,246.36	1,273.46	1,300.55	1,327.65	1,354.74	1,408.93	1,463.12	1,517.31	1,571.50	1,625.69
26	1,042.61	1,070.79	1,098.97	1,127.15	1,155.32	1,183.50	1,211.68	1,239.86	1,268.04	1,296.22	1,324.40	1,352.57	1,380.75	1,408.93	1,465.29	1,521.64	1,578.00	1,634.36	1,690.72
27	1,082.71	1,111.97	1,141.23	1,170.50	1,199.76	1,229.02	1,258.28	1,287.55	1,316.81	1,346.07	1,375.33	1,404.60	1,433.86	1,463.12	1,521.64	1,580.17	1,638.69	1,697.22	1,755.74
28	1,122.81	1,153.16	1,183.50	1,213.85	1,244.19	1,274.54	1,304.89	1,335.23	1,365.58	1,395.93	1,426.27	1,456.62	1,486.96	1,517.31	1,578.00	1,638.69	1,699.39	1,760.08	1,820.77
29	1,162.91	1,194.34	1,225.77	1,257.20	1,288.63	1,320.06	1,351.49	1,382.92	1,414.35	1,445.78	1,477.21	1,508.64	1,540.07	1,571.50	1,634.36	1,697.22	1,760.08	1,822.94	1,885.80
30*	1,203.01	1,235.52	1,268.04	1,300.55	1,333.07	1,365.58	1,398.09	1,430.61	1,463.12	1,495.63	1,528.15	1,560.66	1,593.17	1,625.69	1,690.72	1,755.74	1,820.77	1,885.80	1,950.83
31*	1,243.11	1,276.71	1,310.31	1,343.90	1,377.50	1,411.10	1,444.70	1,478.29	1,511.89	1,545.49	1,579.09	1,612.68	1,646.28	1,679.88	1,747.07	1,814.27	1,881.46	1,948.66	2,015.85
32*	1,283.21	1,317.89	1,352.57	1,387.25	1,421.94	1,456.62	1,491.30	1,525.98	1,560.66	1,595.34	1,630.02	1,664.70	1,699.39	1,734.07	1,803.43	1,872.79	1,942.15	2,011.52	2,080.88
33*	1,323.31	1,359.08	1,394.84	1,430.61	1,466.37	1,502.14	1,537.90	1,573.67	1,609.43	1,645.20	1,680.96	1,716.73	1,752.49	1,788.26	1,859.79	1,931.32	2,002.85	2,074.38	2,145.91
34*	1,363.41	1,400.26	1,437.11	1,473.96	1,510.81	1,547.66	1,584.50	1,621.35	1,658.20	1,695.05	1,731.90	1,768.75	1,805.60	1,842.45	1,916.14	1,989.84	2,063.54	2,137.24	2,210.93
35*	1,403.51	1,441.44	1,479.38	1,517.31	1,555.24	1,593.17	1,631.11	1,669.04	1,706.97	1,744.91	1,782.84	1,820.77	1,858.70	1,896.64	1,972.50	2,048.37	2,124.23	2,200.10	2,275.96
36*	1,443.61	1,482.63	1,521.64	1,560.66	1,599.68	1,638.69	1,677.71	1,716.73	1,755.74	1,794.76	1,833.78	1,872.79	1,911.81	1,950.83	2,028.86	2,106.89	2,184.92	2,262.96	2,340.99
38*	1,523.81	1,565.00	1,606.18	1,647.36	1,688.55	1,729.73	1,770.92	1,812.10	1,853.28	1,894.47	1,935.65	1,976.84	2,018.02	2,059.20	2,141.57	2,223.94	2,306.31	2,388.68	2,471.04
40*	1,604.01	1,647.36	1,690.72	1,734.07	1,777.42	1,820.77	1,864.12	1,907.47	1,950.83	1,994.18	2,037.53	2,080.88	2,124.23	2,167.58	2,254.29	2,340.99	2,427.69	2,514.40	2,601.10
42*	1,684.21	1,729.73	1,775.25	1,820.77	1,866.29	1,911.81	1,957.33	2,002.85	2,048.37	2,093.89	2,139.40	2,184.92	2,230.44	2,275.96	2,367.00	2,458.04	2,549.08	2,640.12	2,731.15
44*	1,764.41	1,812.10	1,859.79	1,907.47	1,955.16	2,002.85	2,050.53	2,098.22	2,145.91	2,193.59	2,241.28	2,288.97	2,336.65	2,384.34	2,479.71	2,575.09	2,670.46	2,765.83	2,861.21
46*	1,844.61	1,894.47	1,944.32	1,994.18	2,044.03	2,093.89	2,143.74	2,193.59	2,243.45	2,293.30	2,343.16	2,393.01	2,442.87	2,492.72	2,592.43	2,692.14	2,791.85	2,891.55	2,991.26
48*	1,924.81	1,976.84	2,028.86	2,080.88	2,132.90	2,184.92	2,236.95	2,288.97	2,340.99	2,393.01	2,445.03	2,497.05	2,549.08	2,601.10	2,705.14	2,809.19	2,913.23	3,017.27	3,121.32
50*	2,005.01	2,059.20	2,113.39	2,167.58	2,221.77	2,275.96	2,330.15	2,384.34	2,438.53	2,492.72	2,546.91	2,601.10	2,655.29	2,709.48	2,817.86	2,926.24	3,034.61	3,142.99	3,251.37
52*	2,085.22	2,141.57	2,197.93	2,254.29	2,310.64	2,367.00	2,423.36	2,479.71	2,536.07	2,592.43	2,648.79	2,705.14	2,761.50	2,817.86	2,930.57	3,043.28	3,156.00	3,268.71	3,381.43
54*	2,165.42	2,223.94	2,282.46	2,340.99	2,399.51	2,458.04	2,516.56	2,575.09	2,633.61	2,692.14	2,750.66	2,809.19	2,867.71	2,926.24	3,043.28	3,160.33	3,277.38	3,394.43	3,511.48
56*	2,245.62	2,306.31	2,367.00	2,427.69	2,488.38	2,549.08	2,609.77	2,670.46	2,731.15	2,791.85	2,852.54	2,913.23	2,973.92	3,034.61	3,156.00	3,277.38	3,398.77	3,520.15	3,641.54
58*	2,325.82	2,388.68	2,451.54	2,514.40	2,577.26	2,640.12	2,702.97	2,765.83	2,828.69	2,891.55	2,954.41	3,017.27	3,080.13	3,142.99	3,268.71	3,394.43	3,520.15	3,645.87	3,771.59
60*	2,406.02	2,471.04	2,536.07	2,601.10	2,666.13	2,731.15	2,796.18	2,861.21	2,926.24	2,991.26	3,056.29	3,121.32	3,186.34	3,251.37	3,381.43	3,511.48	3,641.54	3,771.59	3,901.65
61+	EMAIL FOR QUOTE																		

\*Oversize charges will apply

### PRICE AS LISTED



Brushed

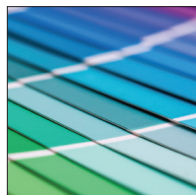

Painted

### OPTIONAL ANODIZED FINISHES - EMAIL FOR QUOTE



Clear

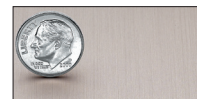

Champagne



Gold



Black



Light Bronze



Medium Bronze



Dark Bronze

# Your Logo 4" Deep Aluminum without Back

**PRICE PER LOGO.** Including standard mounting with pattern.

*Logos smaller than 10" x 10" or with more than 3 pieces email for quote*

Size	16"	17"	18"	19"	20"	21"	22"	23"	24"	25"	26"*	27"	28"*	29"	30"*	31"	32"*	33"	34"*	35"	36"*
16"	\$261.19	\$277.52	\$293.84	\$310.17	\$326.49	\$342.82	\$359.14	\$375.47	\$391.79	\$408.11	\$424.44	\$440.76	\$457.09	\$473.41	\$489.74	\$506.06	\$522.38	\$538.71	\$555.03	\$571.36	\$587.68
17	277.52	294.86	312.21	329.55	346.90	364.24	381.59	398.93	416.28	433.62	450.97	468.31	485.66	503.00	520.34	537.69	555.03	572.38	589.72	607.07	624.41
18	293.84	312.21	330.57	348.94	367.30	385.67	404.03	422.40	440.76	459.13	477.49	495.86	514.22	532.59	550.95	569.32	587.68	606.05	624.41	642.78	661.14
19	310.17	329.55	348.94	368.32	387.71	407.09	426.48	445.86	465.25	484.63	504.02	523.41	542.79	562.18	581.56	600.95	620.33	639.72	659.10	678.49	697.87
20	326.49	346.90	367.30	387.71	408.11	428.52	448.93	469.33	489.74	510.14	530.55	550.95	571.36	591.76	612.17	632.57	652.98	673.39	693.79	714.20	734.60
21	342.82	364.24	385.67	407.09	428.52	449.95	471.37	492.80	514.22	535.65	557.07	578.50	599.93	621.35	642.78	664.20	685.63	707.05	728.48	749.91	771.33
22	359.14	381.59	404.03	426.48	448.93	471.37	493.82	516.26	538.71	561.16	583.60	606.05	628.49	650.94	673.39	695.83	718.28	740.72	763.17	785.62	808.06
23	375.47	398.93	422.40	445.86	469.33	492.80	516.26	539.73	563.20	586.66	610.13	633.59	657.06	680.53	703.99	727.46	750.93	774.39	797.86	821.33	844.79
24	391.79	416.28	440.76	465.25	489.74	514.22	538.71	563.20	587.68	612.17	636.66	661.14	685.63	710.12	734.60	759.09	783.57	808.06	832.55	857.03	881.52
25	408.11	433.62	459.13	484.63	510.14	535.65	561.16	586.66	612.17	637.68	663.18	688.69	714.20	739.70	765.21	790.72	816.22	841.73	867.24	892.74	918.25
26	424.44	450.97	477.49	504.02	530.55	557.07	583.60	610.13	636.66	663.18	689.71	716.24	742.76	769.29	795.82	822.35	848.87	875.40	901.93	928.45	954.98
27	440.76	468.31	495.86	523.41	550.95	578.50	606.05	633.59	661.14	688.69	716.24	743.78	771.33	798.88	826.43	853.97	881.52	909.07	936.62	964.16	991.71
28	457.09	485.66	514.22	542.79	571.36	599.93	628.49	657.06	685.63	714.20	742.76	771.33	799.90	828.47	857.03	885.60	914.17	942.74	971.31	999.87	1,028.44
29	473.41	503.00	532.59	562.18	591.76	621.35	650.94	680.53	710.12	739.70	769.29	798.88	828.47	858.05	887.64	917.23	946.82	976.41	1,005.99	1,035.58	1,065.17
30*	489.74	520.34	550.95	581.56	612.17	642.78	673.39	703.99	734.60	765.21	795.82	826.43	857.03	887.64	918.25	948.86	979.47	1,010.08	1,040.68	1,071.29	1,101.90
31*	506.06	537.69	569.32	600.95	632.57	664.20	695.83	727.46	759.09	790.72	822.35	853.97	885.60	917.23	948.86	980.49	1,012.12	1,043.74	1,075.37	1,107.00	1,138.63
32*	522.38	555.03	587.68	620.33	652.98	685.63	718.28	750.93	783.57	816.22	848.87	881.52	914.17	946.82	979.47	1,012.12	1,044.76	1,077.41	1,110.06	1,142.71	1,175.36
33*	538.71	572.38	606.05	639.72	673.39	707.05	740.72	774.39	808.06	841.73	875.40	909.07	942.74	976.41	1,010.08	1,043.74	1,077.41	1,111.08	1,144.75	1,178.42	1,212.09
34*	555.03	589.72	624.41	659.10	693.79	728.48	763.17	797.86	832.55	867.24	901.93	936.62	971.31	1,005.99	1,040.68	1,075.37	1,110.06	1,144.75	1,179.44	1,214.13	1,248.82
35*	571.36	607.07	642.78	678.49	714.20	749.91	785.62	821.33	857.03	892.74	928.45	964.16	999.87	1,035.58	1,071.29	1,107.00	1,142.71	1,178.42	1,214.13	1,249.84	1,285.55
36*	587.68	624.41	661.14	697.87	734.60	771.33	808.06	844.79	881.52	918.25	954.98	991.71	1,028.44	1,065.17	1,101.90	1,138.63	1,175.36	1,212.09	1,248.82	1,285.55	1,322.28
38*	620.33	659.10	697.87	736.64	775.41	814.18	852.95	891.72	930.49	969.26	1,008.04	1,046.81	1,085.58	1,124.35	1,163.12	1,201.89	1,240.66	1,279.43	1,318.20	1,356.97	1,395.74
40*	652.98	693.79	734.60	775.41	816.22	857.03	897.85	938.66	979.47	1,020.28	1,061.09	1,101.90	1,142.71	1,183.52	1,224.33	1,265.14	1,305.95	1,346.77	1,387.58	1,428.39	1,469.20
42*	685.63	728.48	771.33	814.18	857.03	899.89	942.74	985.59	1,028.44	1,071.29	1,114.14	1,157.00	1,199.85	1,242.70	1,285.55	1,328.40	1,371.25	1,414.10	1,456.96	1,499.81	1,542.66
44*	718.28	763.17	808.06	852.95	897.85	942.74	987.63	1,032.52	1,077.41	1,122.31	1,167.20	1,212.09	1,256.98	1,301.87	1,346.77	1,391.66	1,436.55	1,481.44	1,526.33	1,571.23	1,616.12
46*	750.93	797.86	844.79	891.72	938.66	985.59	1,032.52	1,079.45	1,126.39	1,173.32	1,220.25	1,267.18	1,314.12	1,361.05	1,407.98	1,454.91	1,501.85	1,548.78	1,595.71	1,642.65	1,689.58
48*	783.57	832.55	881.52	930.49	979.47	1,028.44	1,077.41	1,126.39	1,175.36	1,224.33	1,273.31	1,322.28	1,371.25	1,420.23	1,469.20	1,518.17	1,567.14	1,616.12	1,665.09	1,714.06	1,763.04
50*	816.22	867.24	918.25	969.26	1,020.28	1,071.29	1,122.31	1,173.32	1,224.33	1,275.35	1,326.36	1,377.37	1,428.39	1,479.40	1,530.42	1,581.43	1,632.44	1,683.46	1,734.47	1,785.48	1,836.50
52*	848.87	901.93	954.98	1,008.04	1,061.09	1,114.14	1,167.20	1,220.25	1,273.31	1,326.36	1,379.41	1,432.47	1,485.52	1,538.58	1,591.63	1,644.69	1,697.74	1,750.79	1,803.85	1,856.90	1,909.96
54*	881.52	936.62	991.71	1,046.81	1,101.90	1,157.00	1,212.09	1,267.18	1,322.28	1,377.37	1,432.47	1,487.56	1,542.66	1,597.75	1,652.85	1,707.94	1,763.04	1,818.13	1,873.23	1,928.32	1,983.42
56*	914.17	971.31	1,028.44	1,085.58	1,142.71	1,199.85	1,256.98	1,314.12	1,371.25	1,428.39	1,485.52	1,542.66	1,599.79	1,656.93	1,714.06	1,771.20	1,828.33	1,885.47	1,942.61	1,999.74	2,056.88
58*	946.82	1,005.99	1,065.17	1,124.35	1,183.52	1,242.70	1,301.87	1,361.05	1,420.23	1,479.40	1,538.58	1,597.75	1,656.93	1,716.10	1,775.28	1,834.46	1,893.63	1,952.81	2,011.98	2,071.16	2,130.34
60*	979.47	1,040.68	1,101.90	1,163.12	1,224.33	1,285.55	1,346.77	1,407.98	1,469.20	1,530.42	1,591.63	1,652.85	1,714.06	1,775.28	1,836.50	1,897.71	1,958.93	2,020.15	2,081.36	2,142.58	2,203.80
61+	EMAIL FOR QUOTE																				

\*Oversize charges will apply

## PRICE AS LISTED



Brushed

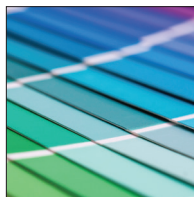

Painted

## OPTIONAL ANODIZED FINISHES - EMAIL FOR QUOTE



Clear



Champagne



Gold



Black

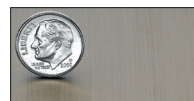

Light Bronze

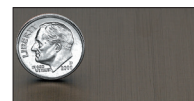

Medium Bronze



Dark Bronze

# Your Logo 4" Deep Aluminum without Back

PRICE PER LOGO. Including standard mounting with pattern.

Logos smaller than 10" x 10" or with more than 3 pieces email for quote

Size	37"*	38"*	39"*	40"*	41"*	42"*	43"*	44"*	45"*	46"*	47"*	48"	49"*	50"	52"*	54"	56"*	58"	60"*
16"	\$604.01	\$620.33	\$636.66	\$652.98	\$669.30	\$685.63	\$701.95	\$718.28	\$734.60	\$750.93	\$767.25	\$783.57	\$799.90	\$816.22	\$848.87	\$881.52	\$914.17	\$946.82	\$979.47
17	641.76	659.10	676.45	693.79	711.14	728.48	745.82	763.17	780.51	797.86	815.20	832.55	849.89	867.24	901.93	936.62	971.31	1,005.99	1,040.68
18	679.51	697.87	716.24	734.60	752.97	771.33	789.70	808.06	826.43	844.79	863.16	881.52	899.89	918.25	954.98	991.71	1,028.44	1,065.17	1,101.90
19	717.26	736.64	756.03	775.41	794.80	814.18	833.57	852.95	872.34	891.72	911.11	930.49	949.88	969.26	1,008.04	1,046.81	1,085.58	1,124.35	1,163.12
20	755.01	775.41	795.82	816.22	836.63	857.03	877.44	897.85	918.25	938.66	959.06	979.47	999.87	1,020.28	1,061.09	1,101.90	1,142.71	1,183.52	1,224.33
21	792.76	814.18	835.61	857.03	878.46	899.89	921.31	942.74	964.16	985.59	1,007.01	1,028.44	1,049.87	1,071.29	1,114.14	1,157.00	1,199.85	1,242.70	1,285.55
22	830.51	852.95	875.40	897.85	920.29	942.74	965.18	987.63	1,010.08	1,032.52	1,054.97	1,077.41	1,099.86	1,122.31	1,167.20	1,212.09	1,256.98	1,301.87	1,346.77
23	868.26	891.72	915.19	938.66	962.12	985.59	1,009.06	1,032.52	1,055.99	1,079.45	1,102.92	1,126.39	1,149.85	1,173.32	1,220.25	1,267.18	1,314.12	1,361.05	1,407.98
24	906.01	930.49	954.98	979.47	1,003.95	1,028.44	1,052.93	1,077.41	1,101.90	1,126.39	1,150.87	1,175.36	1,199.85	1,224.33	1,273.31	1,322.28	1,371.25	1,420.23	1,469.20
25	943.76	969.26	994.77	1,020.28	1,045.79	1,071.29	1,096.80	1,122.31	1,147.81	1,173.32	1,198.83	1,224.33	1,249.84	1,275.35	1,326.36	1,377.37	1,428.39	1,479.40	1,530.42
26	981.51	1,008.04	1,034.56	1,061.09	1,087.62	1,114.14	1,140.67	1,167.20	1,193.72	1,220.25	1,246.78	1,273.31	1,299.83	1,326.36	1,379.41	1,432.47	1,485.52	1,538.58	1,591.63
27	1,019.26	1,046.81	1,074.35	1,101.90	1,129.45	1,157.00	1,184.54	1,212.09	1,239.64	1,267.18	1,294.73	1,322.28	1,349.83	1,377.37	1,432.47	1,487.56	1,542.66	1,597.75	1,652.85
28	1,057.01	1,085.58	1,114.14	1,142.71	1,171.28	1,199.85	1,228.41	1,256.98	1,285.55	1,314.12	1,342.68	1,371.25	1,399.82	1,428.39	1,485.52	1,542.66	1,599.79	1,656.93	1,714.06
29	1,094.76	1,124.35	1,153.93	1,183.52	1,213.11	1,242.70	1,272.29	1,301.87	1,331.46	1,361.05	1,390.64	1,420.23	1,449.81	1,479.40	1,538.58	1,597.75	1,656.93	1,716.10	1,775.28
30*	1,132.51	1,163.12	1,193.72	1,224.33	1,254.94	1,285.55	1,316.16	1,346.77	1,377.37	1,407.98	1,438.59	1,469.20	1,499.81	1,530.42	1,591.63	1,652.85	1,714.06	1,775.28	1,836.50
31*	1,170.26	1,201.89	1,233.52	1,265.14	1,296.77	1,328.40	1,360.03	1,391.66	1,423.29	1,454.91	1,486.54	1,518.17	1,549.80	1,581.43	1,644.69	1,707.94	1,771.20	1,834.46	1,897.71
32*	1,208.01	1,240.66	1,273.31	1,305.95	1,338.60	1,371.25	1,403.90	1,436.55	1,469.20	1,501.85	1,534.50	1,567.14	1,599.79	1,632.44	1,697.74	1,763.04	1,828.33	1,893.63	1,958.93
33*	1,245.76	1,279.43	1,313.10	1,346.77	1,380.43	1,414.10	1,447.77	1,481.44	1,515.11	1,548.78	1,582.45	1,616.12	1,649.79	1,683.46	1,750.79	1,818.13	1,885.47	1,952.81	2,020.15
34*	1,283.51	1,318.20	1,352.89	1,387.58	1,422.27	1,456.96	1,491.64	1,526.33	1,561.02	1,595.71	1,630.40	1,665.09	1,699.78	1,734.47	1,803.85	1,873.23	1,942.61	2,011.98	2,081.36
35*	1,321.26	1,356.97	1,392.68	1,428.39	1,464.10	1,499.81	1,535.52	1,571.23	1,606.94	1,642.65	1,678.35	1,714.06	1,749.77	1,785.48	1,856.90	1,928.32	1,999.74	2,071.16	2,142.58
36*	1,359.01	1,395.74	1,432.47	1,469.20	1,505.93	1,542.66	1,579.39	1,616.12	1,652.85	1,689.58	1,726.31	1,763.04	1,799.77	1,836.50	1,909.96	1,983.42	2,056.88	2,130.34	2,203.80
38*	1,434.51	1,473.28	1,512.05	1,550.82	1,589.59	1,628.36	1,667.13	1,705.90	1,744.67	1,783.44	1,822.21	1,860.98	1,899.75	1,938.52	2,016.07	2,093.61	2,171.15	2,248.69	2,326.23
40*	1,510.01	1,550.82	1,591.63	1,632.44	1,673.25	1,714.06	1,754.88	1,795.69	1,836.50	1,877.31	1,918.12	1,958.93	1,999.74	2,040.55	2,122.17	2,203.80	2,285.42	2,367.04	2,448.66
42*	1,585.51	1,628.36	1,671.21	1,714.06	1,756.92	1,799.77	1,842.62	1,885.47	1,928.32	1,971.17	2,014.02	2,056.88	2,099.73	2,142.58	2,228.28	2,313.99	2,399.69	2,485.39	2,571.09
44*	1,661.01	1,705.90	1,750.79	1,795.69	1,840.58	1,885.47	1,930.36	1,975.25	2,020.15	2,065.04	2,109.93	2,154.82	2,199.71	2,244.61	2,334.39	2,424.17	2,513.96	2,603.74	2,693.53
46*	1,736.51	1,783.44	1,830.38	1,877.31	1,924.24	1,971.17	2,018.11	2,065.04	2,111.97	2,158.90	2,205.84	2,252.77	2,299.70	2,346.63	2,440.50	2,534.36	2,628.23	2,722.09	2,815.96
48*	1,812.01	1,860.98	1,909.96	1,958.93	2,007.90	2,056.88	2,105.85	2,154.82	2,203.80	2,252.77	2,301.74	2,350.71	2,399.69	2,448.66	2,546.61	2,644.55	2,742.50	2,840.45	2,938.39
50*	1,887.51	1,938.52	1,989.54	2,040.55	2,091.57	2,142.58	2,193.59	2,244.61	2,295.62	2,346.63	2,397.65	2,448.66	2,499.67	2,550.69	2,652.72	2,754.74	2,856.77	2,958.80	3,060.83
52*	1,963.01	2,016.07	2,069.12	2,122.17	2,175.23	2,228.28	2,281.34	2,334.39	2,387.44	2,440.50	2,493.55	2,546.61	2,599.66	2,652.72	2,758.82	2,864.93	2,971.04	3,077.15	3,183.26
54*	2,038.51	2,093.61	2,148.70	2,203.80	2,258.89	2,313.99	2,369.08	2,424.17	2,479.27	2,534.36	2,589.46	2,644.55	2,699.65	2,754.74	2,864.93	2,975.12	3,085.31	3,195.50	3,305.69
56*	2,114.01	2,171.15	2,228.28	2,285.42	2,342.55	2,399.69	2,456.82	2,513.96	2,571.09	2,628.23	2,685.36	2,742.50	2,799.64	2,856.77	2,971.04	3,085.31	3,199.58	3,313.85	3,428.12
58*	2,189.51	2,248.69	2,307.86	2,367.04	2,426.22	2,485.39	2,544.57	2,603.74	2,662.92	2,722.09	2,781.27	2,840.45	2,899.62	2,958.80	3,077.15	3,195.50	3,313.85	3,432.20	3,550.56
60*	2,265.01	2,326.23	2,387.44	2,448.66	2,509.88	2,571.09	2,632.31	2,693.53	2,754.74	2,815.96	2,877.18	2,938.39	2,999.61	3,060.83	3,183.26	3,305.69	3,428.12	3,550.56	3,672.99
61+	EMAIL FOR QUOTE																		

\*Oversize charges will apply

### PRICE AS LISTED



Brushed

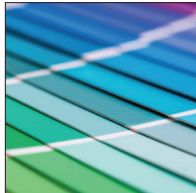

Painted

### OPTIONAL ANODIZED FINISHES - EMAIL FOR QUOTE



Clear



Champagne



Gold



Black



Light Bronze



Medium Bronze



Dark Bronze



# Your Logo 4" Deep Aluminum with Back

**PRICE PER LOGO.** Including standard mounting with pattern.

*Logos smaller than 10" x 10" or with more than 3 pieces email for quote*

Size	16"	17"	18"	19"	20"	21"	22"	23"	24"	25"	26"*	27"	28"*	29"	30"*	31"	32"*	33"	34"*	35"	36"*
16"	\$298.39	\$317.04	\$335.69	\$354.34	\$372.99	\$391.64	\$410.29	\$428.94	\$447.59	\$466.24	\$484.89	\$503.54	\$522.19	\$540.84	\$559.49	\$578.14	\$596.78	\$615.43	\$634.08	\$652.73	\$671.38
17	317.04	336.86	356.67	376.49	396.30	416.12	435.93	455.75	475.56	495.38	515.19	535.01	554.82	574.64	594.45	614.27	634.08	653.90	673.71	693.53	713.34
18	335.69	356.67	377.65	398.64	419.62	440.60	461.58	482.56	503.54	524.52	545.50	566.48	587.46	608.44	629.42	650.40	671.38	692.36	713.34	734.32	755.30
19	354.34	376.49	398.64	420.78	442.93	465.07	487.22	509.37	531.51	553.66	575.80	597.95	620.10	642.24	664.39	686.54	708.68	730.83	752.97	775.12	797.27
20	372.99	396.30	419.62	442.93	466.24	489.55	512.86	536.17	559.49	582.80	606.11	629.42	652.73	676.04	699.36	722.67	745.98	769.29	792.60	815.92	839.23
21	391.64	416.12	440.60	465.07	489.55	514.03	538.51	562.98	587.46	611.94	636.41	660.89	685.37	709.85	734.32	758.80	783.28	807.76	832.23	856.71	881.19
22	410.29	435.93	461.58	487.22	512.86	538.51	564.15	589.79	615.43	641.08	666.72	692.36	718.01	743.65	769.29	794.93	820.58	846.22	871.86	897.51	923.15
23	428.94	455.75	482.56	509.37	536.17	562.98	589.79	616.60	643.41	670.22	697.03	723.83	750.64	777.45	804.26	831.07	857.88	884.68	911.49	938.30	965.11
24	447.59	475.56	503.54	531.51	559.49	587.46	615.43	643.41	671.38	699.36	727.33	755.30	783.28	811.25	839.23	867.20	895.17	923.15	951.12	979.10	1,007.07
25	466.24	495.38	524.52	553.66	582.80	611.94	641.08	670.22	699.36	728.50	757.64	786.78	815.92	845.05	874.19	903.33	932.47	961.61	990.75	1,019.89	1,049.03
26	484.89	515.19	545.50	575.80	606.11	636.41	666.72	697.03	727.33	757.64	787.94	818.25	848.55	878.86	909.16	939.47	969.77	1,000.08	1,030.38	1,060.69	1,090.99
27	503.54	535.01	566.48	597.95	629.42	660.89	692.36	723.83	755.30	786.78	818.25	849.72	881.19	912.66	944.13	975.60	1,007.07	1,038.54	1,070.01	1,101.48	1,132.95
28	522.19	554.82	587.46	620.10	652.73	685.37	718.01	750.64	783.28	815.92	848.55	881.19	913.82	946.46	979.10	1,011.73	1,044.37	1,077.01	1,109.64	1,142.28	1,174.92
29	540.84	574.64	608.44	642.24	676.04	709.85	743.65	777.45	811.25	845.05	878.86	912.66	946.46	980.26	1,014.06	1,047.87	1,081.67	1,115.47	1,149.27	1,183.07	1,216.88
30*	559.49	594.45	629.42	664.39	699.36	734.32	769.29	804.26	839.23	874.19	909.16	944.13	979.10	1,014.06	1,049.03	1,084.00	1,118.97	1,153.94	1,188.90	1,223.87	1,258.84
31*	578.14	614.27	650.40	686.54	722.67	758.80	794.93	831.07	867.20	903.33	939.47	975.60	1,011.73	1,047.87	1,084.00	1,120.13	1,156.27	1,192.40	1,228.53	1,264.67	1,300.80
32*	596.78	634.08	671.38	708.68	745.98	783.28	820.58	857.88	895.17	932.47	969.77	1,007.07	1,044.37	1,081.67	1,118.97	1,156.27	1,193.56	1,230.86	1,268.16	1,305.46	1,342.76
33*	615.43	653.90	692.36	730.83	769.29	807.76	846.22	884.68	923.15	961.61	1,000.08	1,038.54	1,077.01	1,115.47	1,153.94	1,192.40	1,230.86	1,269.33	1,307.79	1,346.26	1,384.72
34*	634.08	673.71	713.34	752.97	792.60	832.23	871.86	911.49	951.12	990.75	1,030.38	1,070.01	1,109.64	1,149.27	1,188.90	1,228.53	1,268.16	1,307.79	1,347.42	1,387.05	1,426.68
35*	652.73	693.53	734.32	775.12	815.92	856.71	897.51	938.30	979.10	1,019.89	1,060.69	1,101.48	1,142.28	1,183.07	1,223.87	1,264.67	1,305.46	1,346.26	1,387.05	1,427.85	1,468.64
36*	671.38	713.34	755.30	797.27	839.23	881.19	923.15	965.11	1,007.07	1,049.03	1,090.99	1,132.95	1,174.92	1,216.88	1,258.84	1,300.80	1,342.76	1,384.72	1,426.68	1,468.64	1,510.60
38*	708.68	752.97	797.27	841.56	885.85	930.14	974.43	1,018.73	1,063.02	1,107.31	1,151.60	1,195.90	1,240.19	1,284.48	1,328.77	1,373.07	1,417.36	1,461.65	1,505.94	1,550.23	1,594.53
40*	745.98	792.60	839.23	885.85	932.47	979.10	1,025.72	1,072.34	1,118.97	1,165.59	1,212.21	1,258.84	1,305.46	1,352.08	1,398.71	1,445.33	1,491.95	1,538.58	1,585.20	1,631.83	1,678.45
42*	783.28	832.23	881.19	930.14	979.10	1,028.05	1,077.01	1,125.96	1,174.92	1,223.87	1,272.82	1,321.78	1,370.73	1,419.69	1,468.64	1,517.60	1,566.55	1,615.51	1,664.46	1,713.42	1,762.37
44*	820.58	871.86	923.15	974.43	1,025.72	1,077.01	1,128.29	1,179.58	1,230.86	1,282.15	1,333.44	1,384.72	1,436.01	1,487.29	1,538.58	1,589.86	1,641.15	1,692.44	1,743.72	1,795.01	1,846.29
46*	857.88	911.49	965.11	1,018.73	1,072.34	1,125.96	1,179.58	1,233.19	1,286.81	1,340.43	1,394.05	1,447.66	1,501.28	1,554.90	1,608.51	1,662.13	1,715.75	1,769.36	1,822.98	1,876.60	1,930.22
48*	895.17	951.12	1,007.07	1,063.02	1,118.97	1,174.92	1,230.86	1,286.81	1,342.76	1,398.71	1,454.66	1,510.60	1,566.55	1,622.50	1,678.45	1,734.40	1,790.34	1,846.29	1,902.24	1,958.19	2,014.14
50*	932.47	990.75	1,049.03	1,107.31	1,165.59	1,223.87	1,282.15	1,340.43	1,398.71	1,456.99	1,515.27	1,573.55	1,631.83	1,690.10	1,748.38	1,806.66	1,864.94	1,923.22	1,981.50	2,039.78	2,098.06
52*	969.77	1,030.38	1,090.99	1,151.60	1,212.21	1,272.82	1,333.44	1,394.05	1,454.66	1,515.27	1,575.88	1,636.49	1,697.10	1,757.71	1,818.32	1,878.93	1,939.54	2,000.15	2,060.76	2,121.37	2,181.98
54*	1,007.07	1,070.01	1,132.95	1,195.90	1,258.84	1,321.78	1,384.72	1,447.66	1,510.60	1,573.55	1,636.49	1,699.43	1,762.37	1,825.31	1,888.25	1,951.20	2,014.14	2,077.08	2,140.02	2,202.96	2,265.90
56*	1,044.37	1,109.64	1,174.92	1,240.19	1,305.46	1,370.73	1,436.01	1,501.28	1,566.55	1,631.83	1,697.10	1,762.37	1,827.64	1,892.92	1,958.19	2,023.46	2,088.73	2,154.01	2,219.28	2,284.55	2,349.83
58*	1,081.67	1,149.27	1,216.88	1,284.48	1,352.08	1,419.69	1,487.29	1,554.90	1,622.50	1,690.10	1,757.71	1,825.31	1,892.92	1,960.52	2,028.12	2,095.73	2,163.33	2,230.94	2,298.54	2,366.14	2,433.75
60*	1,118.97	1,188.90	1,258.84	1,328.77	1,398.71	1,468.64	1,538.58	1,608.51	1,678.45	1,748.38	1,818.32	1,888.25	1,958.19	2,028.12	2,098.06	2,167.99	2,237.93	2,307.87	2,377.80	2,447.74	2,517.67
61+	<b>EMAIL FOR QUOTE</b>																				

\*Oversize charges will apply

## PRICE AS LISTED

## OPTIONAL ANODIZED FINISHES - EMAIL FOR QUOTE



Brushed

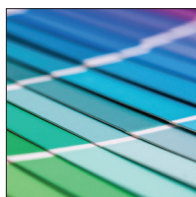

Painted



Clear

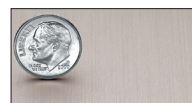

Champagne

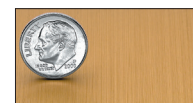

Gold



Black



Light Bronze

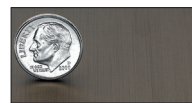

Medium Bronze

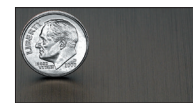

Dark Bronze

# Your Logo 4" Deep Aluminum with Back

PRICE PER LOGO. Including standard mounting with pattern.

Logos smaller than 10" x 10" or with more than 3 pieces email for quote

Size	37"*	38"*	39"*	40"*	41"*	42"*	43"*	44"*	45"*	46"*	47"*	48"	49"*	50"	52"*	54"	56"*	58"	60"*
16"	\$690.03	\$708.68	\$727.33	\$745.98	\$764.63	\$783.28	\$801.93	\$820.58	\$839.23	\$857.88	\$876.53	\$895.17	\$913.82	\$932.47	\$969.77	\$1,007.07	\$1,044.37	\$1,081.67	\$1,118.97
17	733.16	752.97	772.79	792.60	812.42	832.23	852.05	871.86	891.68	911.49	931.31	951.12	970.94	990.75	1,030.38	1,070.01	1,109.64	1,149.27	1,188.90
18	776.29	797.27	818.25	839.23	860.21	881.19	902.17	923.15	944.13	965.11	986.09	1,007.07	1,028.05	1,049.03	1,090.99	1,132.95	1,174.92	1,216.88	1,258.84
19	819.41	841.56	863.70	885.85	908.00	930.14	952.29	974.43	996.58	1,018.73	1,040.87	1,063.02	1,085.17	1,107.31	1,151.60	1,195.90	1,240.19	1,284.48	1,328.77
20	862.54	885.85	909.16	932.47	955.79	979.10	1,002.41	1,025.72	1,049.03	1,072.34	1,095.66	1,118.97	1,142.28	1,165.59	1,212.21	1,258.84	1,305.46	1,352.08	1,398.71
21	905.67	930.14	954.62	979.10	1,003.57	1,028.05	1,052.53	1,077.01	1,101.48	1,125.96	1,150.44	1,174.92	1,199.39	1,223.87	1,272.82	1,321.78	1,370.73	1,419.69	1,468.64
22	948.79	974.43	1,000.08	1,025.72	1,051.36	1,077.01	1,102.65	1,128.29	1,153.94	1,179.58	1,205.22	1,230.86	1,256.51	1,282.15	1,333.44	1,384.72	1,436.01	1,487.29	1,538.58
23	991.92	1,018.73	1,045.54	1,072.34	1,099.15	1,125.96	1,152.77	1,179.58	1,206.39	1,233.19	1,260.00	1,286.81	1,313.62	1,340.43	1,394.05	1,447.66	1,501.28	1,554.90	1,608.51
24	1,035.05	1,063.02	1,090.99	1,118.97	1,146.94	1,174.92	1,202.89	1,230.86	1,258.84	1,286.81	1,314.79	1,342.76	1,370.73	1,398.71	1,454.66	1,510.60	1,566.55	1,622.50	1,678.45
25	1,078.17	1,107.31	1,136.45	1,165.59	1,194.73	1,223.87	1,253.01	1,282.15	1,311.29	1,340.43	1,369.57	1,398.71	1,427.85	1,456.99	1,515.27	1,573.55	1,631.83	1,690.10	1,748.38
26	1,121.30	1,151.60	1,181.91	1,212.21	1,242.52	1,272.82	1,303.13	1,333.44	1,363.74	1,394.05	1,424.35	1,454.66	1,484.96	1,515.27	1,575.88	1,636.49	1,697.10	1,757.71	1,818.32
27	1,164.43	1,195.90	1,227.37	1,258.84	1,290.31	1,321.78	1,353.25	1,384.72	1,416.19	1,447.66	1,479.13	1,510.60	1,542.08	1,573.55	1,636.49	1,699.43	1,762.37	1,825.31	1,888.25
28	1,207.55	1,240.19	1,272.82	1,305.46	1,338.10	1,370.73	1,403.37	1,436.01	1,468.64	1,501.28	1,533.92	1,566.55	1,599.19	1,631.83	1,697.10	1,762.37	1,827.64	1,892.92	1,958.19
29	1,250.68	1,284.48	1,318.28	1,352.08	1,385.89	1,419.69	1,453.49	1,487.29	1,521.09	1,554.90	1,588.70	1,622.50	1,656.30	1,690.10	1,757.71	1,825.31	1,892.92	1,960.52	2,028.12
30*	1,293.81	1,328.77	1,363.74	1,398.71	1,433.68	1,468.64	1,503.61	1,538.58	1,573.55	1,608.51	1,643.48	1,678.45	1,713.42	1,748.38	1,818.32	1,888.25	1,958.19	2,028.12	2,098.06
31*	1,336.93	1,373.07	1,409.20	1,445.33	1,481.46	1,517.60	1,553.73	1,589.86	1,626.00	1,662.13	1,698.26	1,734.40	1,770.53	1,806.66	1,878.93	1,951.20	2,023.46	2,095.73	2,167.99
32*	1,380.06	1,417.36	1,454.66	1,491.95	1,529.25	1,566.55	1,603.85	1,641.15	1,678.45	1,715.75	1,753.05	1,790.34	1,827.64	1,864.94	1,939.54	2,014.14	2,088.73	2,163.33	2,237.93
33*	1,423.19	1,461.65	1,500.11	1,538.58	1,577.04	1,615.51	1,653.97	1,692.44	1,730.90	1,769.36	1,807.83	1,846.29	1,884.76	1,923.22	2,000.15	2,077.08	2,154.01	2,230.94	2,307.87
34*	1,466.31	1,505.94	1,545.57	1,585.20	1,624.83	1,664.46	1,704.09	1,743.72	1,783.35	1,822.98	1,862.61	1,902.24	1,941.87	1,981.50	2,060.76	2,140.02	2,219.28	2,298.54	2,377.80
35*	1,509.44	1,550.23	1,591.03	1,631.83	1,672.62	1,713.42	1,754.21	1,795.01	1,835.80	1,876.60	1,917.39	1,958.19	1,998.98	2,039.78	2,121.37	2,202.96	2,284.55	2,366.14	2,447.74
36*	1,552.57	1,594.53	1,636.49	1,678.45	1,720.41	1,762.37	1,804.33	1,846.29	1,888.25	1,930.22	1,972.18	2,014.14	2,056.10	2,098.06	2,181.98	2,265.90	2,349.83	2,433.75	2,517.67
38*	1,638.82	1,683.11	1,727.40	1,771.70	1,815.99	1,860.28	1,904.57	1,948.86	1,993.16	2,037.45	2,081.74	2,126.03	2,170.33	2,214.62	2,303.20	2,391.79	2,480.37	2,568.96	2,657.54
40*	1,725.07	1,771.70	1,818.32	1,864.94	1,911.57	1,958.19	2,004.81	2,051.44	2,098.06	2,144.68	2,191.31	2,237.93	2,284.55	2,331.18	2,424.42	2,517.67	2,610.92	2,704.16	2,797.41
42*	1,811.33	1,860.28	1,909.23	1,958.19	2,007.14	2,056.10	2,105.05	2,154.01	2,202.96	2,251.92	2,300.87	2,349.83	2,398.78	2,447.74	2,545.64	2,643.55	2,741.46	2,839.37	2,937.28
44*	1,897.58	1,948.86	2,000.15	2,051.44	2,102.72	2,154.01	2,205.29	2,256.58	2,307.87	2,359.15	2,410.44	2,461.72	2,513.01	2,564.29	2,666.87	2,769.44	2,872.01	2,974.58	3,077.15
46*	1,983.83	2,037.45	2,091.07	2,144.68	2,198.30	2,251.92	2,305.53	2,359.15	2,412.77	2,466.38	2,520.00	2,573.62	2,627.24	2,680.85	2,788.09	2,895.32	3,002.55	3,109.79	3,217.02
48*	2,070.09	2,126.03	2,181.98	2,237.93	2,293.88	2,349.83	2,405.77	2,461.72	2,517.67	2,573.62	2,629.57	2,685.51	2,741.46	2,797.41	2,909.31	3,021.20	3,133.10	3,245.00	3,356.89
50*	2,156.34	2,214.62	2,272.90	2,331.18	2,389.46	2,447.74	2,506.01	2,564.29	2,622.57	2,680.85	2,739.13	2,797.41	2,855.69	2,913.97	3,030.53	3,147.09	3,263.65	3,380.20	3,496.76
52*	2,242.59	2,303.20	2,363.81	2,424.42	2,485.03	2,545.64	2,606.26	2,666.87	2,727.48	2,788.09	2,848.70	2,909.31	2,969.92	3,030.53	3,151.75	3,272.97	3,394.19	3,515.41	3,636.63
54*	2,328.85	2,391.79	2,454.73	2,517.67	2,580.61	2,643.55	2,706.50	2,769.44	2,832.38	2,895.32	2,958.26	3,021.20	3,084.15	3,147.09	3,272.97	3,398.85	3,524.74	3,650.62	3,776.50
56*	2,415.10	2,480.37	2,545.64	2,610.92	2,676.19	2,741.46	2,806.74	2,872.01	2,937.28	3,002.55	3,067.83	3,133.10	3,198.37	3,263.65	3,394.19	3,524.74	3,655.28	3,785.83	3,916.37
58*	2,501.35	2,568.96	2,636.56	2,704.16	2,771.77	2,839.37	2,906.98	2,974.58	3,042.18	3,109.79	3,177.39	3,245.00	3,312.60	3,380.20	3,515.41	3,650.62	3,785.83	3,921.04	4,056.24
60*	2,587.61	2,657.54	2,727.48	2,797.41	2,867.35	2,937.28	3,007.22	3,077.15	3,147.09	3,217.02	3,286.96	3,356.89	3,426.83	3,496.76	3,636.63	3,776.50	3,916.37	4,056.24	4,196.11
61+	EMAIL FOR QUOTE																		

\*Oversize charges will apply

### PRICE AS LISTED



Brushed



Painted

### OPTIONAL ANODIZED FINISHES - EMAIL FOR QUOTE



Clear



Champagne



Gold



Black



Light Bronze



Medium Bronze



Dark Bronze

# Your Logo 5" Deep Aluminum without Back

**PRICE PER LOGO.** Including standard mounting with pattern.

*Logos smaller than 10" x 10" or with more than 3 pieces email for quote*

Size	16"	17"	18"	19"	20"	21"	22"	23"	24"	25"	26"*	27"	28"*	29"	30"*	31"	32"*	33"	34"*	35"	36"*
16"	\$314.60	\$334.27	\$353.93	\$373.59	\$393.25	\$412.92	\$432.58	\$452.24	\$471.90	\$491.57	\$511.23	\$530.89	\$550.55	\$570.22	\$589.88	\$609.54	\$629.20	\$648.87	\$668.53	\$688.19	\$707.85
17	334.27	355.16	376.05	396.94	417.83	438.72	459.62	480.51	501.40	522.29	543.18	564.07	584.96	605.86	626.75	647.64	668.53	689.42	710.31	731.20	752.10
18	353.93	376.05	398.17	420.29	442.41	464.53	486.65	508.77	530.89	553.01	575.13	597.25	619.37	641.49	663.61	685.73	707.85	729.98	752.10	774.22	796.34
19	373.59	396.94	420.29	443.64	466.99	490.34	513.69	537.04	560.39	583.74	607.08	630.43	653.78	677.13	700.48	723.83	747.18	770.53	793.88	817.23	840.58
20	393.25	417.83	442.41	466.99	491.57	516.15	540.72	565.30	589.88	614.46	639.04	663.61	688.19	712.77	737.35	761.93	786.50	811.08	835.66	860.24	884.82
21	412.92	438.72	464.53	490.34	516.15	541.95	567.76	593.57	619.37	645.18	670.99	696.79	722.60	748.41	774.22	800.02	825.83	851.64	877.44	903.25	929.06
22	432.58	459.62	486.65	513.69	540.72	567.76	594.80	621.83	648.87	675.90	702.94	729.98	757.01	784.05	811.08	838.12	865.15	892.19	919.23	946.26	973.30
23	452.24	480.51	508.77	537.04	565.30	593.57	621.83	650.10	678.36	706.63	734.89	763.16	791.42	819.69	847.95	876.22	904.48	932.74	961.01	989.27	1,017.54
24	471.90	501.40	530.89	560.39	589.88	619.37	648.87	678.36	707.85	737.35	766.84	796.34	825.83	855.32	884.82	914.31	943.80	973.30	1,002.79	1,032.29	1,061.78
25	491.57	522.29	553.01	583.74	614.46	645.18	675.90	706.63	737.35	768.07	798.79	829.52	860.24	890.96	921.68	952.41	983.13	1,013.85	1,044.58	1,075.30	1,106.02
26	511.23	543.18	575.13	607.08	639.04	670.99	702.94	734.89	766.84	798.79	830.75	862.70	894.65	926.60	958.55	990.50	1,022.45	1,054.41	1,086.36	1,118.31	1,150.26
27	530.89	564.07	597.25	630.43	663.61	696.79	729.98	763.16	796.34	829.52	862.70	895.88	929.06	962.24	995.42	1,028.60	1,061.78	1,094.96	1,128.14	1,161.32	1,194.50
28	550.55	584.96	619.37	653.78	688.19	722.60	757.01	791.42	825.83	860.24	894.65	929.06	963.47	997.88	1,032.29	1,066.70	1,101.10	1,135.51	1,169.92	1,204.33	1,238.74
29	570.22	605.86	641.49	677.13	712.77	748.41	784.05	819.69	855.32	890.96	926.60	962.24	997.88	1,033.52	1,069.15	1,104.79	1,140.43	1,176.07	1,211.71	1,247.34	1,282.98
30*	589.88	626.75	663.61	700.48	737.35	774.22	811.08	847.95	884.82	921.68	958.55	995.42	1,032.29	1,069.15	1,106.02	1,142.89	1,179.75	1,216.62	1,253.49	1,290.36	1,327.22
31*	609.54	647.64	685.73	723.83	761.93	800.02	838.12	876.22	914.31	952.41	990.50	1,028.60	1,066.70	1,104.79	1,142.89	1,180.98	1,219.08	1,257.18	1,295.27	1,333.37	1,371.46
32*	629.20	668.53	707.85	747.18	786.50	825.83	865.15	904.48	943.80	983.13	1,022.45	1,061.78	1,101.10	1,140.43	1,179.75	1,219.08	1,258.40	1,297.73	1,337.05	1,376.38	1,415.70
33*	648.87	689.42	729.98	770.53	811.08	851.64	892.19	932.74	973.30	1,013.85	1,054.41	1,094.96	1,135.51	1,176.07	1,216.62	1,257.18	1,297.73	1,338.28	1,378.84	1,419.39	1,459.95
34*	668.53	710.31	752.10	793.88	835.66	877.44	919.23	961.01	1,002.79	1,044.58	1,086.36	1,128.14	1,169.92	1,211.71	1,253.49	1,295.27	1,337.05	1,378.84	1,420.62	1,462.40	1,504.19
35*	688.19	731.20	774.22	817.23	860.24	903.25	946.26	989.27	1,032.29	1,075.30	1,118.31	1,161.32	1,204.33	1,247.34	1,290.36	1,333.37	1,376.38	1,419.39	1,462.40	1,505.42	1,548.43
36*	707.85	752.10	796.34	840.58	884.82	929.06	973.30	1,017.54	1,061.78	1,106.02	1,150.26	1,194.50	1,238.74	1,282.98	1,327.22	1,371.46	1,415.70	1,459.95	1,504.19	1,548.43	1,592.67
38*	747.18	793.88	840.58	887.28	933.97	980.67	1,027.37	1,074.07	1,120.77	1,167.47	1,214.16	1,260.86	1,307.56	1,354.26	1,400.96	1,447.66	1,494.35	1,541.05	1,587.75	1,634.45	1,681.15
40*	786.50	835.66	884.82	933.97	983.13	1,032.29	1,081.44	1,130.60	1,179.75	1,228.91	1,278.07	1,327.22	1,376.38	1,425.54	1,474.69	1,523.85	1,573.00	1,622.16	1,671.32	1,720.47	1,769.63
42*	825.83	877.44	929.06	980.67	1,032.29	1,083.90	1,135.51	1,187.13	1,238.74	1,290.36	1,341.97	1,393.58	1,445.20	1,496.81	1,548.43	1,600.04	1,651.65	1,703.27	1,754.88	1,806.50	1,858.11
44*	865.15	919.23	973.30	1,027.37	1,081.44	1,135.51	1,189.59	1,243.66	1,297.73	1,351.80	1,405.87	1,459.95	1,514.02	1,568.09	1,622.16	1,676.23	1,730.30	1,784.38	1,838.45	1,892.52	1,946.59
46*	904.48	961.01	1,017.54	1,074.07	1,130.60	1,187.13	1,243.66	1,300.19	1,356.72	1,413.25	1,469.78	1,526.31	1,582.84	1,639.37	1,695.90	1,752.43	1,808.95	1,865.48	1,922.01	1,978.54	2,035.07
48*	943.80	1,002.79	1,061.78	1,120.77	1,179.75	1,238.74	1,297.73	1,356.72	1,415.70	1,474.69	1,533.68	1,592.67	1,651.65	1,710.64	1,769.63	1,828.62	1,887.60	1,946.59	2,005.58	2,064.57	2,123.55
50*	983.13	1,044.58	1,106.02	1,167.47	1,228.91	1,290.36	1,351.80	1,413.25	1,474.69	1,536.14	1,597.58	1,659.03	1,720.47	1,781.92	1,843.36	1,904.81	1,966.25	2,027.70	2,089.15	2,150.59	2,212.04
52*	1,022.45	1,086.36	1,150.26	1,214.16	1,278.07	1,341.97	1,405.87	1,469.78	1,533.68	1,597.58	1,661.49	1,725.39	1,789.29	1,853.20	1,917.10	1,981.00	2,044.90	2,108.81	2,172.71	2,236.61	2,300.52
54*	1,061.78	1,128.14	1,194.50	1,260.86	1,327.22	1,393.58	1,459.95	1,526.31	1,592.67	1,659.03	1,725.39	1,791.75	1,858.11	1,924.47	1,990.83	2,057.19	2,123.55	2,189.92	2,256.28	2,322.64	2,389.00
56*	1,101.10	1,169.92	1,238.74	1,307.56	1,376.38	1,445.20	1,514.02	1,582.84	1,651.65	1,720.47	1,789.29	1,858.11	1,926.93	1,995.75	2,064.57	2,133.39	2,202.20	2,271.02	2,339.84	2,408.66	2,477.48
58*	1,140.43	1,211.71	1,282.98	1,354.26	1,425.54	1,496.81	1,568.09	1,639.37	1,710.64	1,781.92	1,853.20	1,924.47	1,995.75	2,067.03	2,138.30	2,209.58	2,280.85	2,352.13	2,423.41	2,494.68	2,565.96
60*	1,179.75	1,253.49	1,327.22	1,400.96	1,474.69	1,548.43	1,622.16	1,695.90	1,769.63	1,843.36	1,917.10	1,990.83	2,064.57	2,138.30	2,212.04	2,285.77	2,359.50	2,433.24	2,506.97	2,580.71	2,654.44
61+	EMAIL FOR QUOTE																				

\*Oversize charges will apply

## PRICE AS LISTED



Brushed

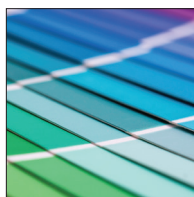

Painted

## OPTIONAL ANODIZED FINISHES - EMAIL FOR QUOTE



Clear

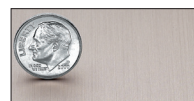

Champagne



Gold



Black



Light Bronze



Medium Bronze



Dark Bronze



Your Logo 5" Deep Aluminum without Back

PRICE PER LOGO. Including standard mounting with pattern.

Logos smaller than 10" x 10" or with more than 3 pieces email for quote

Size	37"*	38"*	39"*	40"*	41"*	42"*	43"*	44"*	45"*	46"*	47"*	48"	49"*	50"	52"*	54"	56"*	58"	60"*
16"	\$727.52	\$747.18	\$766.84	\$786.50	\$806.17	\$825.83	\$845.49	\$865.15	\$884.82	\$904.48	\$924.14	\$943.80	\$963.47	\$983.13	\$1,022.45	\$1,061.78	\$1,101.10	\$1,140.43	\$1,179.75
17	772.99	793.88	814.77	835.66	856.55	877.44	898.34	919.23	940.12	961.01	981.90	1,002.79	1,023.68	1,044.58	1,086.36	1,128.14	1,169.92	1,211.71	1,253.49
18	818.46	840.58	862.70	884.82	906.94	929.06	951.18	973.30	995.42	1,017.54	1,039.66	1,061.78	1,083.90	1,106.02	1,150.26	1,194.50	1,238.74	1,282.98	1,327.22
19	863.93	887.28	910.62	933.97	957.32	980.67	1,004.02	1,027.37	1,050.72	1,074.07	1,097.42	1,120.77	1,144.12	1,167.47	1,214.16	1,260.86	1,307.56	1,354.26	1,400.96
20	909.40	933.97	958.55	983.13	1,007.71	1,032.29	1,056.86	1,081.44	1,106.02	1,130.60	1,155.18	1,179.75	1,204.33	1,228.91	1,278.07	1,327.22	1,376.38	1,425.54	1,474.69
21	954.87	980.67	1,006.48	1,032.29	1,058.09	1,083.90	1,109.71	1,135.51	1,161.32	1,187.13	1,212.94	1,238.74	1,264.55	1,290.36	1,341.97	1,393.58	1,445.20	1,496.81	1,548.43
22	1,000.33	1,027.37	1,054.41	1,081.44	1,108.48	1,135.51	1,162.55	1,189.59	1,216.62	1,243.66	1,270.69	1,297.73	1,324.77	1,351.80	1,405.87	1,459.95	1,514.02	1,568.09	1,622.16
23	1,045.80	1,074.07	1,102.33	1,130.60	1,158.86	1,187.13	1,215.39	1,243.66	1,271.92	1,300.19	1,328.45	1,356.72	1,384.98	1,413.25	1,469.78	1,526.31	1,582.84	1,639.37	1,695.90
24	1,091.27	1,120.77	1,150.26	1,179.75	1,209.25	1,238.74	1,268.24	1,297.73	1,327.22	1,356.72	1,386.21	1,415.70	1,445.20	1,474.69	1,533.68	1,592.67	1,651.65	1,710.64	1,769.63
25	1,136.74	1,167.47	1,198.19	1,228.91	1,259.63	1,290.36	1,321.08	1,351.80	1,382.52	1,413.25	1,443.97	1,474.69	1,505.42	1,536.14	1,597.58	1,659.03	1,720.47	1,781.92	1,843.36
26	1,182.21	1,214.16	1,246.12	1,278.07	1,310.02	1,341.97	1,373.92	1,405.87	1,437.83	1,469.78	1,501.73	1,533.68	1,565.63	1,597.58	1,661.49	1,725.39	1,789.29	1,853.20	1,917.10
27	1,227.68	1,260.86	1,294.04	1,327.22	1,360.40	1,393.58	1,426.77	1,459.95	1,493.13	1,526.31	1,559.49	1,592.67	1,625.85	1,659.03	1,725.39	1,791.75	1,858.11	1,924.47	1,990.83
28	1,273.15	1,307.56	1,341.97	1,376.38	1,410.79	1,445.20	1,479.61	1,514.02	1,548.43	1,582.84	1,617.25	1,651.65	1,686.06	1,720.47	1,789.29	1,858.11	1,926.93	1,995.75	2,064.57
29	1,318.62	1,354.26	1,389.90	1,425.54	1,461.17	1,496.81	1,532.45	1,568.09	1,603.73	1,639.37	1,675.00	1,710.64	1,746.28	1,781.92	1,853.20	1,924.47	1,995.75	2,067.03	2,138.30
30*	1,364.09	1,400.96	1,437.83	1,474.69	1,511.56	1,548.43	1,585.29	1,622.16	1,659.03	1,695.90	1,732.76	1,769.63	1,806.50	1,843.36	1,917.10	1,990.83	2,064.57	2,138.30	2,212.04
31*	1,409.56	1,447.66	1,485.75	1,523.85	1,561.94	1,600.04	1,638.14	1,676.23	1,714.33	1,752.43	1,790.52	1,828.62	1,866.71	1,904.81	1,981.00	2,057.19	2,133.39	2,209.58	2,285.77
32*	1,455.03	1,494.35	1,533.68	1,573.00	1,612.33	1,651.65	1,690.98	1,730.30	1,769.63	1,808.95	1,848.28	1,887.60	1,926.93	1,966.25	2,044.90	2,123.55	2,202.20	2,280.85	2,359.50
33*	1,500.50	1,541.05	1,581.61	1,622.16	1,662.72	1,703.27	1,743.82	1,784.38	1,824.93	1,865.48	1,906.04	1,946.59	1,987.15	2,027.70	2,108.81	2,189.92	2,271.02	2,352.13	2,433.24
34*	1,545.97	1,587.75	1,629.53	1,671.32	1,713.10	1,754.88	1,796.67	1,838.45	1,880.23	1,922.01	1,963.80	2,005.58	2,047.36	2,089.15	2,172.71	2,256.28	2,339.84	2,423.41	2,506.97
35*	1,591.44	1,634.45	1,677.46	1,720.47	1,763.49	1,806.50	1,849.51	1,892.52	1,935.53	1,978.54	2,021.56	2,064.57	2,107.58	2,150.59	2,236.61	2,322.64	2,408.66	2,494.68	2,580.71
36*	1,636.91	1,681.15	1,725.39	1,769.63	1,813.87	1,858.11	1,902.35	1,946.59	1,990.83	2,035.07	2,079.31	2,123.55	2,167.80	2,212.04	2,300.52	2,389.00	2,477.48	2,565.96	2,654.44
38*	1,727.85	1,774.55	1,821.24	1,867.94	1,914.64	1,961.34	2,008.04	2,054.74	2,101.43	2,148.13	2,194.83	2,241.53	2,288.23	2,334.93	2,475.02	2,521.72	2,615.12	2,708.51	2,801.91
40*	1,818.79	1,867.94	1,917.10	1,966.25	2,015.41	2,064.57	2,113.72	2,162.88	2,212.04	2,261.19	2,310.35	2,359.50	2,408.66	2,457.82	2,605.29	2,654.44	2,752.75	2,851.07	2,949.38
42*	1,909.73	1,961.34	2,012.95	2,064.57	2,116.18	2,167.80	2,219.41	2,271.02	2,322.64	2,374.25	2,425.87	2,477.48	2,529.09	2,580.71	2,735.55	2,787.16	2,890.39	2,993.62	3,096.85
44*	2,000.66	2,054.74	2,108.81	2,162.88	2,216.95	2,271.02	2,325.10	2,379.17	2,433.24	2,487.31	2,541.38	2,595.45	2,649.53	2,703.60	2,865.81	2,919.89	3,028.03	3,136.17	3,244.32
46*	2,091.60	2,148.13	2,204.66	2,261.19	2,317.72	2,374.25	2,430.78	2,487.31	2,543.84	2,600.37	2,656.90	2,713.43	2,769.96	2,826.49	2,996.08	3,052.61	3,165.67	3,278.73	3,391.79
48*	2,182.54	2,241.53	2,300.52	2,359.50	2,418.49	2,477.48	2,536.47	2,595.45	2,654.44	2,713.43	2,772.42	2,831.40	2,890.39	2,949.38	3,126.34	3,185.33	3,303.30	3,421.28	3,539.25
50*	2,273.48	2,334.93	2,396.37	2,457.82	2,519.26	2,580.71	2,642.15	2,703.60	2,765.04	2,826.49	2,887.93	2,949.38	3,010.83	3,072.27	3,256.61	3,318.05	3,440.94	3,563.83	3,686.72
52*	2,364.42	2,428.32	2,492.23	2,556.13	2,620.03	2,683.94	2,747.84	2,811.74	2,875.65	2,939.55	3,003.45	3,067.35	3,131.26	3,195.16	3,386.87	3,450.77	3,578.58	3,706.39	3,834.19
54*	2,455.36	2,521.72	2,588.08	2,654.44	2,720.80	2,787.16	2,853.53	2,919.89	2,986.25	3,052.61	3,118.97	3,185.33	3,251.69	3,318.05	3,517.13	3,583.50	3,716.22	3,848.94	3,981.66
56*	2,546.30	2,615.12	2,683.94	2,752.75	2,821.57	2,890.39	2,959.21	3,028.03	3,096.85	3,165.67	3,234.49	3,303.30	3,372.12	3,440.94	3,647.40	3,716.22	3,853.85	3,991.49	4,129.13
58*	2,637.24	2,708.51	2,779.79	2,851.07	2,922.34	2,993.62	3,064.90	3,136.17	3,207.45	3,278.73	3,350.00	3,421.28	3,492.56	3,563.83	3,777.66	3,848.94	3,991.49	4,134.05	4,276.60
60*	2,728.18	2,801.91	2,875.65	2,949.38	3,023.11	3,096.85	3,170.58	3,244.32	3,318.05	3,391.79	3,465.52	3,539.25	3,612.99	3,686.72	3,907.93	3,981.66	4,129.13	4,276.60	4,424.07
61+	<b>EMAIL FOR QUOTE</b>																		

\*Oversize charges will apply

PRICE AS LISTED



Brushed

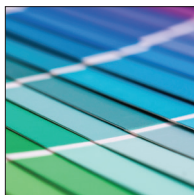

Painted

OPTIONAL ANODIZED FINISHES - EMAIL FOR QUOTE



Clear

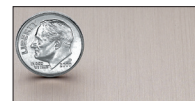

Champagne

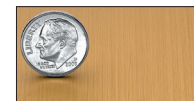

Gold



Black



Light Bronze

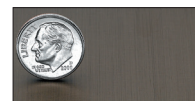

Medium Bronze



Dark Bronze

# Your Logo 5" Deep Aluminum with Back

**PRICE PER LOGO.** Including standard mounting with pattern.

*Logos smaller than 10" x 10" or with more than 3 pieces email for quote*

Size	16"	17"	18"	19"	20"	21"	22"	23"	24"	25"	26"	27"	28"	29"	30"	31"	32"	33"	34"	35"	36"
16"	\$369.02	\$392.09	\$415.15	\$438.22	\$461.28	\$484.34	\$507.41	\$530.47	\$553.53	\$576.60	\$599.66	\$622.73	\$645.79	\$668.85	\$691.92	\$714.98	\$738.04	\$761.11	\$784.17	\$807.24	\$830.30
17	392.09	416.59	441.10	465.60	490.11	514.61	539.12	563.63	588.13	612.64	637.14	661.65	686.15	710.66	735.16	759.67	784.17	808.68	833.18	857.69	882.19
18	415.15	441.10	467.05	492.99	518.94	544.89	570.83	596.78	622.73	648.67	674.62	700.57	726.51	752.46	778.41	804.35	830.30	856.25	882.19	908.14	934.09
19	438.22	465.60	492.99	520.38	547.77	575.16	602.55	629.93	657.32	684.71	712.10	739.49	766.87	794.26	821.65	849.04	876.43	903.82	931.20	958.59	985.98
20	461.28	490.11	518.94	547.77	576.60	605.43	634.26	663.09	691.92	720.75	749.58	778.41	807.24	836.07	864.90	893.73	922.55	951.38	980.21	1,009.04	1,037.87
21	484.34	514.61	544.89	575.16	605.43	635.70	665.97	696.24	726.51	756.78	787.06	817.33	847.60	877.87	908.14	938.41	968.68	998.95	1,029.22	1,059.50	1,089.77
22	507.41	539.12	570.83	602.55	634.26	665.97	697.68	729.40	761.11	792.82	824.53	856.25	887.96	919.67	951.38	983.10	1,014.81	1,046.52	1,078.24	1,109.95	1,141.66
23	530.47	563.63	596.78	629.93	663.09	696.24	729.40	762.55	795.70	828.86	862.01	895.17	928.32	961.48	994.63	1,027.78	1,060.94	1,094.09	1,127.25	1,160.40	1,193.55
24	553.53	588.13	622.73	657.32	691.92	726.51	761.11	795.70	830.30	864.90	899.49	934.09	968.68	1,003.28	1,037.87	1,072.47	1,107.06	1,141.66	1,176.26	1,210.85	1,245.45
25	576.60	612.64	648.67	684.71	720.75	756.78	792.82	828.86	864.90	900.93	936.97	973.01	1,009.04	1,045.08	1,081.12	1,117.16	1,153.19	1,189.23	1,225.27	1,261.30	1,297.34
26	599.66	637.14	674.62	712.10	749.58	787.06	824.53	862.01	899.49	936.97	974.45	1,011.93	1,049.41	1,086.88	1,124.36	1,161.84	1,199.32	1,236.80	1,274.28	1,311.76	1,349.23
27	622.73	661.65	700.57	739.49	778.41	817.33	856.25	895.17	934.09	973.01	1,011.93	1,050.85	1,089.77	1,128.69	1,167.61	1,206.53	1,245.45	1,284.37	1,323.29	1,362.21	1,401.13
28	645.79	686.15	726.51	766.87	807.24	847.60	887.96	928.32	968.68	1,009.04	1,049.41	1,089.77	1,130.13	1,170.49	1,210.85	1,251.21	1,291.57	1,331.94	1,372.30	1,412.66	1,453.02
29	668.85	710.66	752.46	794.26	836.07	877.87	919.67	961.48	1,003.28	1,045.08	1,086.88	1,128.69	1,170.49	1,212.29	1,254.10	1,295.90	1,337.70	1,379.51	1,421.31	1,463.11	1,504.91
30*	691.92	735.16	778.41	821.65	864.90	908.14	951.38	994.63	1,037.87	1,081.12	1,124.36	1,167.61	1,210.85	1,254.10	1,297.34	1,340.59	1,383.83	1,427.07	1,470.32	1,513.56	1,556.81
31*	714.98	759.67	804.35	849.04	893.73	938.41	983.10	1,027.78	1,072.47	1,117.16	1,161.84	1,206.53	1,251.21	1,295.90	1,340.59	1,385.27	1,429.96	1,474.64	1,519.33	1,564.02	1,608.70
32*	738.04	784.17	830.30	876.43	922.55	968.68	1,014.81	1,060.94	1,107.06	1,153.19	1,199.32	1,245.45	1,291.57	1,337.70	1,383.83	1,429.96	1,476.08	1,522.21	1,568.34	1,614.47	1,660.59
33*	761.11	808.68	856.25	903.82	951.38	998.95	1,046.52	1,094.09	1,141.66	1,189.23	1,236.80	1,284.37	1,331.94	1,379.51	1,427.07	1,474.64	1,522.21	1,569.78	1,617.35	1,664.92	1,712.49
34*	784.17	833.18	882.19	931.20	980.21	1,029.22	1,078.24	1,127.25	1,176.26	1,225.27	1,274.28	1,323.29	1,372.30	1,421.31	1,470.32	1,519.33	1,568.34	1,617.35	1,666.36	1,715.37	1,764.38
35*	807.24	857.69	908.14	958.59	1,009.04	1,059.50	1,109.95	1,160.40	1,210.85	1,261.30	1,311.76	1,362.21	1,412.66	1,463.11	1,513.56	1,564.02	1,614.47	1,664.92	1,715.37	1,765.82	1,816.28
36*	830.30	882.19	934.09	985.98	1,037.87	1,089.77	1,141.66	1,193.55	1,245.45	1,297.34	1,349.23	1,401.13	1,453.02	1,504.91	1,556.81	1,608.70	1,660.59	1,712.49	1,764.38	1,816.28	1,868.17
38*	876.43	931.20	985.98	1,040.76	1,095.53	1,150.31	1,205.09	1,259.86	1,314.64	1,369.42	1,424.19	1,478.97	1,533.74	1,588.52	1,643.30	1,698.07	1,752.85	1,807.63	1,862.40	1,917.18	1,971.96
40*	922.55	980.21	1,037.87	1,095.53	1,153.19	1,210.85	1,268.51	1,326.17	1,383.83	1,441.49	1,499.15	1,556.81	1,614.47	1,672.13	1,729.79	1,787.45	1,845.10	1,902.76	1,960.42	2,018.08	2,075.74
42*	968.68	1,029.22	1,089.77	1,150.31	1,210.85	1,271.39	1,331.94	1,392.48	1,453.02	1,513.56	1,574.11	1,634.65	1,695.19	1,755.73	1,816.28	1,876.82	1,937.36	1,997.90	2,058.44	2,118.99	2,179.53
44*	1,014.81	1,078.24	1,141.66	1,205.09	1,268.51	1,331.94	1,395.36	1,458.79	1,522.21	1,585.64	1,649.06	1,712.49	1,775.91	1,839.34	1,902.76	1,966.19	2,029.61	2,093.04	2,156.47	2,219.89	2,283.32
46*	1,060.94	1,127.25	1,193.55	1,259.86	1,326.17	1,392.48	1,458.79	1,525.10	1,591.40	1,657.71	1,724.02	1,790.33	1,856.64	1,922.95	1,989.25	2,055.56	2,121.87	2,188.18	2,254.49	2,320.79	2,387.10
48*	1,107.06	1,176.26	1,245.45	1,314.64	1,383.83	1,453.02	1,522.21	1,591.40	1,660.59	1,729.79	1,798.98	1,868.17	1,937.36	2,006.55	2,075.74	2,144.93	2,214.12	2,283.32	2,352.51	2,421.70	2,490.89
50*	1,153.19	1,225.27	1,297.34	1,369.42	1,441.49	1,513.56	1,585.64	1,657.71	1,729.79	1,801.86	1,873.93	1,946.01	2,018.08	2,090.16	2,162.23	2,234.31	2,306.38	2,378.45	2,450.53	2,522.60	2,594.68
52*	1,199.32	1,274.28	1,349.23	1,424.19	1,499.15	1,574.11	1,649.06	1,724.02	1,798.98	1,873.93	1,948.89	2,023.85	2,098.81	2,173.76	2,248.72	2,323.68	2,398.63	2,473.59	2,548.55	2,623.51	2,698.46
54*	1,245.45	1,323.29	1,401.13	1,478.97	1,556.81	1,634.65	1,712.49	1,790.33	1,868.17	1,946.01	2,023.85	2,101.69	2,179.53	2,257.37	2,335.21	2,413.05	2,490.89	2,568.73	2,646.57	2,724.41	2,802.25
56*	1,291.57	1,372.30	1,453.02	1,533.74	1,614.47	1,695.19	1,775.91	1,856.64	1,937.36	2,018.08	2,098.81	2,179.53	2,260.25	2,340.98	2,421.70	2,502.42	2,583.14	2,663.87	2,744.59	2,825.31	2,906.04
58*	1,337.70	1,421.31	1,504.91	1,588.52	1,672.13	1,755.73	1,839.34	1,922.95	2,006.55	2,090.16	2,173.76	2,257.37	2,340.98	2,424.58	2,508.19	2,591.79	2,675.40	2,759.01	2,842.61	2,926.22	3,009.82
60*	1,383.83	1,470.32	1,556.81	1,643.30	1,729.79	1,816.28	1,902.76	1,989.25	2,075.74	2,162.23	2,248.72	2,335.21	2,421.70	2,508.19	2,594.68	2,681.17	2,767.65	2,854.14	2,940.63	3,027.12	3,113.61
61+	EMAIL FOR QUOTE																				

\*Oversize charges will apply

## PRICE AS LISTED



Brushed

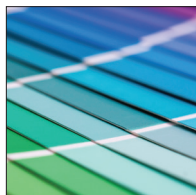

Painted

## OPTIONAL ANODIZED FINISHES - EMAIL FOR QUOTE



Clear



Champagne



Gold



Black



Light Bronze



Medium Bronze



Dark Bronze

## Your Logo 5" Deep Aluminum with Back

**PRICE PER LOGO.** Including standard mounting with pattern.

*Logos smaller than 10" x 10" or with more than 3 pieces email for quote*

Size	37"*	38"*	39"*	40"*	41"*	42"*	43"*	44"*	45"*	46"*	47"*	48"	49"*	50"	52"*	54"	56"*	58"	60"*
16"	\$853.36	\$876.43	\$899.49	\$922.55	\$945.62	\$968.68	\$991.75	\$1,014.81	\$1,037.87	\$1,060.94	\$1,084.00	\$1,107.06	\$1,130.13	\$1,153.19	\$1,199.32	\$1,245.45	\$1,291.57	\$1,337.70	\$1,383.83
17	906.70	931.20	955.71	980.21	1,004.72	1,029.22	1,053.73	1,078.24	1,102.74	1,127.25	1,151.75	1,176.26	1,200.76	1,225.27	1,274.28	1,323.29	1,372.30	1,421.31	1,470.32
18	960.03	985.98	1,011.93	1,037.87	1,063.82	1,089.77	1,115.71	1,141.66	1,167.61	1,193.55	1,219.50	1,245.45	1,271.39	1,297.34	1,349.23	1,401.13	1,453.02	1,504.91	1,556.81
19	1,013.37	1,040.76	1,068.14	1,095.53	1,122.92	1,150.31	1,177.70	1,205.09	1,232.47	1,259.86	1,287.25	1,314.64	1,342.03	1,369.42	1,424.19	1,478.97	1,533.74	1,588.52	1,643.30
20	1,066.70	1,095.53	1,124.36	1,153.19	1,182.02	1,210.85	1,239.68	1,268.51	1,297.34	1,326.17	1,355.00	1,383.83	1,412.66	1,441.49	1,499.15	1,556.81	1,614.47	1,672.13	1,729.79
21	1,120.04	1,150.31	1,180.58	1,210.85	1,241.12	1,271.39	1,301.67	1,331.94	1,362.21	1,392.48	1,422.75	1,453.02	1,483.29	1,513.56	1,574.11	1,634.65	1,695.19	1,755.73	1,816.28
22	1,173.37	1,205.09	1,236.80	1,268.51	1,300.22	1,331.94	1,363.65	1,395.36	1,427.07	1,458.79	1,490.50	1,522.21	1,553.93	1,585.64	1,649.06	1,712.49	1,775.91	1,839.34	1,902.76
23	1,226.71	1,259.86	1,293.02	1,326.17	1,359.32	1,392.48	1,425.63	1,458.79	1,491.94	1,525.10	1,558.25	1,591.40	1,624.56	1,657.71	1,724.02	1,790.33	1,856.64	1,922.95	1,989.25
24	1,280.04	1,314.64	1,349.23	1,383.83	1,418.43	1,453.02	1,487.62	1,522.21	1,556.81	1,591.40	1,626.00	1,660.59	1,695.19	1,729.79	1,798.98	1,868.17	1,937.36	2,006.55	2,075.74
25	1,333.38	1,369.42	1,405.45	1,441.49	1,477.53	1,513.56	1,549.60	1,585.64	1,621.67	1,657.71	1,693.75	1,729.79	1,765.82	1,801.86	1,873.93	1,946.01	2,018.08	2,090.16	2,162.23
26	1,386.71	1,424.19	1,461.67	1,499.15	1,536.63	1,574.11	1,611.58	1,649.06	1,686.54	1,724.02	1,761.50	1,798.98	1,836.46	1,873.93	1,948.89	2,023.85	2,098.81	2,173.76	2,248.72
27	1,440.05	1,478.97	1,517.89	1,556.81	1,595.73	1,634.65	1,673.57	1,712.49	1,751.41	1,790.33	1,829.25	1,868.17	1,907.09	1,946.01	2,023.85	2,101.69	2,179.53	2,257.37	2,335.21
28	1,493.38	1,533.74	1,574.11	1,614.47	1,654.83	1,695.19	1,735.55	1,775.91	1,816.28	1,856.64	1,897.00	1,937.36	1,977.72	2,018.08	2,098.81	2,179.53	2,260.25	2,340.98	2,421.70
29	1,546.72	1,588.52	1,630.32	1,672.13	1,713.93	1,755.73	1,797.54	1,839.34	1,881.14	1,922.95	1,964.75	2,006.55	2,048.35	2,090.16	2,173.76	2,257.37	2,340.98	2,424.58	2,508.19
30*	1,600.05	1,643.30	1,686.54	1,729.79	1,773.03	1,816.28	1,859.52	1,902.76	1,946.01	1,989.25	2,032.50	2,075.74	2,118.99	2,162.23	2,248.72	2,335.21	2,421.70	2,508.19	2,594.68
31*	1,653.39	1,698.07	1,742.76	1,787.45	1,832.13	1,876.82	1,921.50	1,966.19	2,010.88	2,055.56	2,100.25	2,144.93	2,189.62	2,234.31	2,323.68	2,413.05	2,502.42	2,591.79	2,681.17
32*	1,706.72	1,752.85	1,798.98	1,845.10	1,891.23	1,937.36	1,983.49	2,029.61	2,075.74	2,121.87	2,168.00	2,214.12	2,260.25	2,306.38	2,398.63	2,490.89	2,583.14	2,675.40	2,767.65
33*	1,760.06	1,807.63	1,855.20	1,902.76	1,950.33	1,997.90	2,045.47	2,093.04	2,140.61	2,188.18	2,235.75	2,283.32	2,330.89	2,378.45	2,473.59	2,568.73	2,663.87	2,759.01	2,854.14
34*	1,813.39	1,862.40	1,911.41	1,960.42	2,009.43	2,058.44	2,107.46	2,156.47	2,205.48	2,254.49	2,303.50	2,352.51	2,401.52	2,450.53	2,548.55	2,646.57	2,744.59	2,842.61	2,940.63
35*	1,866.73	1,917.18	1,967.63	2,018.08	2,068.54	2,118.99	2,169.44	2,219.89	2,270.34	2,320.79	2,371.25	2,421.70	2,472.15	2,522.60	2,623.51	2,724.41	2,825.31	2,926.22	3,027.12
36*	1,920.06	1,971.96	2,023.85	2,075.74	2,127.64	2,179.53	2,231.42	2,283.32	2,335.21	2,387.10	2,439.00	2,490.89	2,542.78	2,594.68	2,698.46	2,802.25	2,906.04	3,009.82	3,113.61
38*	2,026.73	2,081.51	2,136.28	2,191.06	2,245.84	2,300.61	2,355.39	2,410.17	2,464.94	2,519.72	2,574.50	2,629.27	2,684.05	2,738.83	2,848.38	2,957.93	3,067.48	3,177.04	3,286.59
40*	2,133.40	2,191.06	2,248.72	2,306.38	2,364.04	2,421.70	2,479.36	2,537.02	2,594.68	2,652.34	2,710.00	2,767.65	2,825.31	2,882.97	2,998.29	3,113.61	3,228.93	3,344.25	3,459.57
42*	2,240.07	2,300.61	2,361.16	2,421.70	2,482.24	2,542.78	2,603.33	2,663.87	2,724.41	2,784.95	2,845.50	2,906.04	2,966.58	3,027.12	3,148.21	3,269.29	3,390.38	3,511.46	3,632.55
44*	2,346.74	2,410.17	2,473.59	2,537.02	2,600.44	2,663.87	2,727.29	2,790.72	2,854.14	2,917.57	2,980.99	3,044.42	3,107.85	3,171.27	3,298.12	3,424.97	3,551.82	3,678.67	3,805.52
46*	2,453.41	2,519.72	2,586.03	2,652.34	2,718.64	2,784.95	2,851.26	2,917.57	2,983.88	3,050.19	3,116.49	3,182.80	3,249.11	3,315.42	3,448.04	3,580.65	3,713.27	3,845.89	3,978.50
48*	2,560.08	2,629.27	2,698.46	2,767.65	2,836.85	2,906.04	2,975.23	3,044.42	3,113.61	3,182.80	3,251.99	3,321.18	3,390.38	3,459.57	3,597.95	3,736.33	3,874.71	4,013.10	4,151.48
50*	2,666.75	2,738.83	2,810.90	2,882.97	2,955.05	3,027.12	3,099.20	3,171.27	3,243.34	3,315.42	3,387.49	3,459.57	3,531.64	3,603.72	3,747.86	3,892.01	4,036.16	4,180.31	4,324.46
52*	2,773.42	2,848.38	2,923.34	2,998.29	3,073.25	3,148.21	3,223.16	3,298.12	3,373.08	3,448.04	3,522.99	3,597.95	3,672.91	3,747.86	3,897.78	4,047.69	4,197.61	4,347.52	4,497.44
54*	2,880.09	2,957.93	3,035.77	3,113.61	3,191.45	3,269.29	3,347.13	3,424.97	3,502.81	3,580.65	3,658.49	3,736.33	3,814.17	3,892.01	4,047.69	4,203.37	4,359.05	4,514.73	4,670.41
56*	2,986.76	3,067.48	3,148.21	3,228.93	3,309.65	3,390.38	3,471.10	3,551.82	3,632.55	3,713.27	3,793.99	3,874.71	3,955.44	4,036.16	4,197.61	4,359.05	4,520.50	4,681.95	4,843.39
58*	3,093.43	3,177.04	3,260.64	3,344.25	3,427.85	3,511.46	3,595.07	3,678.67	3,762.28	3,845.89	3,929.49	4,013.10	4,096.70	4,180.31	4,347.52	4,514.73	4,681.95	4,849.16	5,016.37
60*	3,200.10	3,286.59	3,373.08	3,459.57	3,546.06	3,632.55	3,719.03	3,805.52	3,892.01	3,978.50	4,064.99	4,151.48	4,237.97	4,324.46	4,497.44	4,670.41	4,843.39	5,016.37	5,189.35
61+	<b>EMAIL FOR QUOTE</b>																		

\*Oversize charges will apply

### PRICE AS LISTED



Brushed

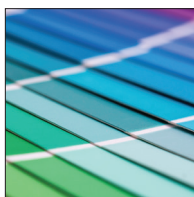

Painted

### OPTIONAL ANODIZED FINISHES - EMAIL FOR QUOTE



Clear

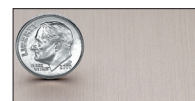

Champagne



Gold



Black



Light Bronze



Medium Bronze



Dark Bronze



# Your Logo 6" Deep Aluminum without Back

**PRICE PER LOGO.** Including standard mounting with pattern.

*Logos smaller than 10" x 10" or with more than 3 pieces email for quote*

Size	16"	17"	18"	19"	20"	21"	22"	23"	24"	25"	26"*	27"	28"*	29"	30"*	31"	32"*	33"	34"*	35"	36"*
16"	\$361.79	\$384.41	\$407.02	\$429.63	\$452.24	\$474.85	\$497.47	\$520.08	\$542.69	\$565.30	\$587.91	\$610.53	\$633.14	\$655.75	\$678.36	\$700.97	\$723.58	\$746.20	\$768.81	\$791.42	\$814.03
17	384.41	408.43	432.46	456.48	480.51	504.53	528.56	552.58	576.61	600.63	624.66	648.68	672.71	696.73	720.76	744.78	768.81	792.83	816.86	840.88	864.91
18	407.02	432.46	457.90	483.33	508.77	534.21	559.65	585.09	610.53	635.96	661.40	686.84	712.28	737.72	763.16	788.59	814.03	839.47	864.91	890.35	915.79
19	429.63	456.48	483.33	510.19	537.04	563.89	590.74	617.59	644.44	671.30	698.15	725.00	751.85	778.70	805.55	832.40	859.26	886.11	912.96	939.81	966.66
20	452.24	480.51	508.77	537.04	565.30	593.57	621.83	650.10	678.36	706.63	734.89	763.16	791.42	819.69	847.95	876.22	904.48	932.74	961.01	989.27	1,017.54
21	474.85	504.53	534.21	563.89	593.57	623.24	652.92	682.60	712.28	741.96	771.64	801.31	830.99	860.67	890.35	920.03	949.70	979.38	1,009.06	1,038.74	1,068.42
22	497.47	528.56	559.65	590.74	621.83	652.92	684.01	715.11	746.20	777.29	808.38	839.47	870.56	901.65	932.74	963.84	994.93	1,026.02	1,057.11	1,088.20	1,119.29
23	520.08	552.58	585.09	617.59	650.10	682.60	715.11	747.61	780.11	812.62	845.12	877.63	910.13	942.64	975.14	1,007.65	1,040.15	1,072.66	1,105.16	1,137.66	1,170.17
24	542.69	576.61	610.53	644.44	678.36	712.28	746.20	780.11	814.03	847.95	881.87	915.79	949.70	983.62	1,017.54	1,051.46	1,085.37	1,119.29	1,153.21	1,187.13	1,221.05
25	565.30	600.63	635.96	671.30	706.63	741.96	777.29	812.62	847.95	883.28	918.61	953.94	989.27	1,024.61	1,059.94	1,095.27	1,130.60	1,165.93	1,201.26	1,236.59	1,271.92
26	587.91	624.66	661.40	698.15	734.89	771.64	808.38	845.12	881.87	918.61	955.36	992.10	1,028.85	1,065.59	1,102.33	1,139.08	1,175.82	1,212.57	1,249.31	1,286.06	1,322.80
27	610.53	648.68	686.84	725.00	763.16	801.31	839.47	877.63	915.79	953.94	992.10	1,030.26	1,068.42	1,106.57	1,144.73	1,182.89	1,221.05	1,259.20	1,297.36	1,335.52	1,373.68
28	633.14	672.71	712.28	751.85	791.42	830.99	870.56	910.13	949.70	989.27	1,028.85	1,068.42	1,107.99	1,147.56	1,187.13	1,226.70	1,266.27	1,305.84	1,345.41	1,384.98	1,424.55
29	655.75	696.73	737.72	778.70	819.69	860.67	901.65	942.64	983.62	1,024.61	1,065.59	1,106.57	1,147.56	1,188.54	1,229.53	1,270.51	1,311.49	1,352.48	1,393.46	1,434.45	1,475.43
30*	678.36	720.76	763.16	805.55	847.95	890.35	932.74	975.14	1,017.54	1,059.94	1,102.33	1,144.73	1,187.13	1,229.53	1,271.92	1,314.32	1,356.72	1,399.11	1,441.51	1,483.91	1,526.31
31*	700.97	744.78	788.59	832.40	876.22	920.03	963.84	1,007.65	1,051.46	1,095.27	1,139.08	1,182.89	1,226.70	1,270.51	1,314.32	1,358.13	1,401.94	1,445.75	1,489.56	1,533.37	1,577.18
32*	723.58	768.81	814.03	859.26	904.48	949.70	994.93	1,040.15	1,085.37	1,130.60	1,175.82	1,221.05	1,266.27	1,311.49	1,356.72	1,401.94	1,447.16	1,492.39	1,537.61	1,582.84	1,628.06
33*	746.20	792.83	839.47	886.11	932.74	979.38	1,026.02	1,072.66	1,119.29	1,165.93	1,212.57	1,259.20	1,305.84	1,352.48	1,399.11	1,445.75	1,492.39	1,539.03	1,585.66	1,632.30	1,678.94
34*	768.81	816.86	864.91	912.96	961.01	1,009.06	1,057.11	1,105.16	1,153.21	1,201.26	1,249.31	1,297.36	1,345.41	1,393.46	1,441.51	1,489.56	1,537.61	1,585.66	1,633.71	1,681.76	1,729.81
35*	791.42	840.88	890.35	939.81	989.27	1,038.74	1,088.20	1,137.66	1,187.13	1,236.59	1,286.06	1,335.52	1,384.98	1,434.45	1,483.91	1,533.37	1,582.84	1,632.30	1,681.76	1,731.23	1,780.69
36*	814.03	864.91	915.79	966.66	1,017.54	1,068.42	1,119.29	1,170.17	1,221.05	1,271.92	1,322.80	1,373.68	1,424.55	1,475.43	1,526.31	1,577.18	1,628.06	1,678.94	1,729.81	1,780.69	1,831.57
38*	859.26	912.96	966.66	1,020.37	1,074.07	1,127.77	1,181.48	1,235.18	1,288.88	1,342.59	1,396.29	1,449.99	1,503.69	1,557.40	1,611.10	1,664.80	1,718.51	1,772.21	1,825.91	1,879.62	1,933.32
40*	904.48	961.01	1,017.54	1,074.07	1,130.60	1,187.13	1,243.66	1,300.19	1,356.72	1,413.25	1,469.78	1,526.31	1,582.84	1,639.37	1,695.90	1,752.43	1,808.95	1,865.48	1,922.01	1,978.54	2,035.07
42*	949.70	1,009.06	1,068.42	1,127.77	1,187.13	1,246.48	1,305.84	1,365.20	1,424.55	1,483.91	1,543.27	1,602.62	1,661.98	1,721.33	1,780.69	1,840.05	1,899.40	1,958.76	2,018.11	2,077.47	2,136.83
44*	994.93	1,057.11	1,119.29	1,181.48	1,243.66	1,305.84	1,368.02	1,430.21	1,492.39	1,554.57	1,616.75	1,678.94	1,741.12	1,803.30	1,865.48	1,927.67	1,989.85	2,052.03	2,114.22	2,176.40	2,238.58
46*	1,040.15	1,105.16	1,170.17	1,235.18	1,300.19	1,365.20	1,430.21	1,495.22	1,560.22	1,625.23	1,690.24	1,755.25	1,820.26	1,885.27	1,950.28	2,015.29	2,080.30	2,145.31	2,210.32	2,275.32	2,340.33
48*	1,085.37	1,153.21	1,221.05	1,288.88	1,356.72	1,424.55	1,492.39	1,560.22	1,628.06	1,695.90	1,763.73	1,831.57	1,899.40	1,967.24	2,035.07	2,102.91	2,170.74	2,238.58	2,306.42	2,374.25	2,442.09
50*	1,130.60	1,201.26	1,271.92	1,342.59	1,413.25	1,483.91	1,554.57	1,625.23	1,695.90	1,766.56	1,837.22	1,907.88	1,978.54	2,049.21	2,119.87	2,190.53	2,261.19	2,331.85	2,402.52	2,473.18	2,543.84
52*	1,175.82	1,249.31	1,322.80	1,396.29	1,469.78	1,543.27	1,616.75	1,690.24	1,763.73	1,837.22	1,910.71	1,984.20	2,057.69	2,131.17	2,204.66	2,278.15	2,351.64	2,425.13	2,498.62	2,572.11	2,645.59
54*	1,221.05	1,297.36	1,373.68	1,449.99	1,526.31	1,602.62	1,678.94	1,755.25	1,831.57	1,907.88	1,984.20	2,060.51	2,136.83	2,213.14	2,289.46	2,365.77	2,442.09	2,518.40	2,594.72	2,671.03	2,747.35
56*	1,266.27	1,345.41	1,424.55	1,503.69	1,582.84	1,661.98	1,741.12	1,820.26	1,899.40	1,978.54	2,057.69	2,136.83	2,215.97	2,295.11	2,374.25	2,453.39	2,532.53	2,611.68	2,690.82	2,769.96	2,849.10
58*	1,311.49	1,393.46	1,475.43	1,557.40	1,639.37	1,721.33	1,803.30	1,885.27	1,967.24	2,049.21	2,131.17	2,213.14	2,295.11	2,377.08	2,459.05	2,541.01	2,622.98	2,704.95	2,786.92	2,868.89	2,950.85
60*	1,356.72	1,441.51	1,526.31	1,611.10	1,695.90	1,780.69	1,865.48	1,950.28	2,035.07	2,119.87	2,204.66	2,289.46	2,374.25	2,459.05	2,543.84	2,628.64	2,713.43	2,798.22	2,883.02	2,967.81	3,052.61
61+	EMAIL FOR QUOTE																				

\*Oversize charges will apply

## PRICE AS LISTED



Brushed

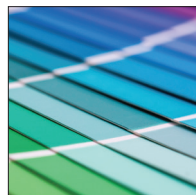

Painted

## OPTIONAL ANODIZED FINISHES - EMAIL FOR QUOTE



Clear



Champagne



Gold



Black



Light Bronze



Medium Bronze



Dark Bronze

# Your Logo 6" Deep Aluminum without Back

**PRICE PER LOGO. Including standard mounting with pattern.**

*Logos smaller than 10" x 10" or with more than 3 pieces email for quote*

Size	37"*	38"*	39"*	40"*	41"*	42"*	43"*	44"*	45"*	46"*	47"*	48"	49"*	50"	52"*	54"	56"*	58"	60"*
16"	\$836.64	\$859.26	\$881.87	\$904.48	\$927.09	\$949.70	\$972.32	\$994.93	\$1,017.54	\$1,040.15	\$1,062.76	\$1,085.37	\$1,107.99	\$1,130.60	\$1,175.82	\$1,221.05	\$1,266.27	\$1,311.49	\$1,356.72
17	888.93	912.96	936.98	961.01	985.03	1,009.06	1,033.09	1,057.11	1,081.14	1,105.16	1,129.19	1,153.21	1,177.24	1,201.26	1,249.31	1,297.36	1,345.41	1,393.46	1,441.51
18	941.22	966.66	992.10	1,017.54	1,042.98	1,068.42	1,093.85	1,119.29	1,144.73	1,170.17	1,195.61	1,221.05	1,246.48	1,271.92	1,322.80	1,373.68	1,424.55	1,475.43	1,526.31
19	993.51	1,020.37	1,047.22	1,074.07	1,100.92	1,127.77	1,154.62	1,181.48	1,208.33	1,235.18	1,262.03	1,288.88	1,315.73	1,342.59	1,396.29	1,449.99	1,503.69	1,557.40	1,611.10
20	1,045.80	1,074.07	1,102.33	1,130.60	1,158.86	1,187.13	1,215.39	1,243.66	1,271.92	1,300.19	1,328.45	1,356.72	1,384.98	1,413.25	1,469.78	1,526.31	1,582.84	1,639.37	1,695.90
21	1,098.09	1,127.77	1,157.45	1,187.13	1,216.81	1,246.48	1,276.16	1,305.84	1,335.52	1,365.20	1,394.88	1,424.55	1,454.23	1,483.91	1,543.27	1,602.62	1,661.98	1,721.33	1,780.69
22	1,150.38	1,181.48	1,212.57	1,243.66	1,274.75	1,305.84	1,336.93	1,368.02	1,399.11	1,430.21	1,461.30	1,492.39	1,523.48	1,554.57	1,616.75	1,678.94	1,741.12	1,803.30	1,865.48
23	1,202.67	1,235.18	1,267.68	1,300.19	1,332.69	1,365.20	1,397.70	1,430.21	1,462.71	1,495.22	1,527.72	1,560.22	1,592.73	1,625.23	1,690.24	1,755.25	1,820.26	1,885.27	1,950.28
24	1,254.96	1,288.88	1,322.80	1,356.72	1,390.64	1,424.55	1,458.47	1,492.39	1,526.31	1,560.22	1,594.14	1,628.06	1,661.98	1,695.90	1,763.73	1,831.57	1,899.40	1,967.24	2,035.07
25	1,307.25	1,342.59	1,377.92	1,413.25	1,448.58	1,483.91	1,519.24	1,554.57	1,589.90	1,625.23	1,660.56	1,695.90	1,731.23	1,766.56	1,837.22	1,907.88	1,978.54	2,049.21	2,119.87
26	1,359.54	1,396.29	1,433.03	1,469.78	1,506.52	1,543.27	1,580.01	1,616.75	1,653.50	1,690.24	1,726.99	1,763.73	1,800.48	1,837.22	1,910.71	1,984.20	2,057.69	2,131.17	2,204.66
27	1,411.83	1,449.99	1,488.15	1,526.31	1,564.46	1,602.62	1,640.78	1,678.94	1,717.09	1,755.25	1,793.41	1,831.57	1,869.72	1,907.88	1,984.20	2,060.51	2,136.83	2,213.14	2,289.46
28	1,464.12	1,503.69	1,543.27	1,582.84	1,622.41	1,661.98	1,701.55	1,741.12	1,780.69	1,820.26	1,859.83	1,899.40	1,938.97	1,978.54	2,057.69	2,136.83	2,215.97	2,295.11	2,374.25
29	1,516.41	1,557.40	1,598.38	1,639.37	1,680.35	1,721.33	1,762.32	1,803.30	1,844.29	1,885.27	1,926.25	1,967.24	2,008.22	2,049.21	2,131.17	2,213.14	2,295.11	2,377.08	2,459.05
30*	1,568.70	1,611.10	1,653.50	1,695.90	1,738.29	1,780.69	1,823.09	1,865.48	1,907.88	1,950.28	1,992.68	2,035.07	2,077.47	2,119.87	2,204.66	2,289.46	2,374.25	2,459.05	2,543.84
31*	1,620.99	1,664.80	1,708.61	1,752.43	1,796.24	1,840.05	1,883.86	1,927.67	1,971.48	2,015.29	2,059.10	2,102.91	2,146.72	2,190.53	2,278.15	2,365.77	2,453.39	2,541.01	2,628.64
32*	1,673.28	1,718.51	1,763.73	1,808.95	1,854.18	1,899.40	1,944.63	1,989.85	2,035.07	2,080.30	2,125.52	2,170.74	2,215.97	2,261.19	2,351.64	2,442.09	2,532.53	2,622.98	2,713.43
33*	1,725.57	1,772.21	1,818.85	1,865.48	1,912.12	1,958.76	2,005.40	2,052.03	2,098.67	2,145.31	2,191.94	2,238.58	2,285.22	2,331.85	2,425.13	2,518.40	2,611.68	2,704.95	2,798.22
34*	1,777.86	1,825.91	1,873.96	1,922.01	1,970.06	2,018.11	2,066.17	2,114.22	2,162.27	2,210.32	2,258.37	2,306.42	2,354.47	2,402.52	2,498.62	2,594.72	2,690.82	2,786.92	2,883.02
35*	1,830.15	1,879.62	1,929.08	1,978.54	2,028.01	2,077.47	2,126.93	2,176.40	2,225.86	2,275.32	2,324.79	2,374.25	2,423.72	2,473.18	2,572.11	2,671.03	2,769.96	2,868.89	2,967.81
36*	1,882.44	1,933.32	1,984.20	2,035.07	2,085.95	2,136.83	2,187.70	2,238.58	2,289.46	2,340.33	2,391.21	2,442.09	2,492.96	2,543.84	2,645.59	2,747.35	2,849.10	2,950.85	3,052.61
38*	1,987.02	2,040.73	2,094.43	2,148.13	2,201.84	2,255.54	2,309.24	2,362.95	2,416.65	2,470.35	2,524.06	2,577.76	2,631.46	2,685.17	2,792.57	2,899.98	3,007.38	3,114.79	3,222.20
40*	2,091.60	2,148.13	2,204.66	2,261.19	2,317.72	2,374.25	2,430.78	2,487.31	2,543.84	2,600.37	2,656.90	2,713.43	2,769.96	2,826.49	2,939.55	3,052.61	3,165.67	3,278.73	3,391.79
42*	2,196.18	2,255.54	2,314.90	2,374.25	2,433.61	2,492.96	2,552.32	2,611.68	2,671.03	2,730.39	2,789.75	2,849.10	2,908.46	2,967.81	3,086.53	3,205.24	3,323.95	3,442.66	3,561.38
44*	2,300.76	2,362.95	2,425.13	2,487.31	2,549.49	2,611.68	2,673.86	2,736.04	2,798.22	2,860.41	2,922.59	2,984.77	3,046.96	3,109.14	3,233.50	3,357.87	3,482.23	3,606.60	3,730.96
46*	2,405.34	2,470.35	2,535.36	2,600.37	2,665.38	2,730.39	2,795.40	2,860.41	2,925.42	2,990.43	3,055.43	3,120.44	3,185.45	3,250.46	3,380.48	3,510.50	3,640.52	3,770.54	3,900.55
48*	2,509.92	2,577.76	2,645.59	2,713.43	2,781.27	2,849.10	2,916.94	2,984.77	3,052.61	3,120.44	3,188.28	3,256.11	3,323.95	3,391.79	3,527.46	3,663.13	3,798.80	3,934.47	4,070.14
50*	2,614.50	2,685.17	2,755.83	2,826.49	2,897.15	2,967.81	3,038.48	3,109.14	3,179.80	3,250.46	3,321.12	3,391.79	3,462.45	3,533.11	3,674.43	3,815.76	3,957.08	4,098.41	4,239.73
52*	2,719.08	2,792.57	2,866.06	2,939.55	3,013.04	3,086.53	3,160.01	3,233.50	3,306.99	3,380.48	3,453.97	3,527.46	3,600.95	3,674.43	3,821.41	3,968.39	4,115.37	4,262.34	4,409.32
54*	2,823.66	2,899.98	2,976.29	3,052.61	3,128.92	3,205.24	3,281.55	3,357.87	3,434.18	3,510.50	3,586.81	3,663.13	3,739.44	3,815.76	3,968.39	4,121.02	4,273.65	4,426.28	4,578.91
56*	2,928.24	3,007.38	3,086.53	3,165.67	3,244.81	3,323.95	3,403.09	3,482.23	3,561.38	3,640.52	3,719.66	3,798.80	3,877.94	3,957.08	4,115.37	4,273.65	4,431.93	4,590.22	4,748.50
58*	3,032.82	3,114.79	3,196.76	3,278.73	3,360.69	3,442.66	3,524.63	3,606.60	3,688.57	3,770.54	3,852.50	3,934.47	4,016.44	4,098.41	4,262.34	4,426.28	4,590.22	4,754.15	4,918.09
60*	3,137.40	3,222.20	3,306.99	3,391.79	3,476.58	3,561.38	3,646.17	3,730.96	3,815.76	3,900.55	3,985.35	4,070.14	4,154.94	4,239.73	4,409.32	4,578.91	4,748.50	4,918.09	5,087.68
61+	EMAIL FOR QUOTE																		

\*Oversize charges will apply

## PRICE AS LISTED



Brushed

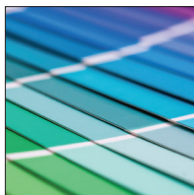

Painted

## OPTIONAL ANODIZED FINISHES - EMAIL FOR QUOTE



Clear



Champagne



Gold



Black



Light Bronze

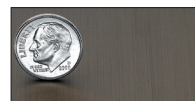

Medium Bronze



Dark Bronze

# Your Logo 6" Deep Aluminum with Back

**PRICE PER LOGO.** Including standard mounting with pattern.

*Logos smaller than 10" x 10" or with more than 3 pieces email for quote*

Size	16"	17"	18"	19"	20"	21"	22"	23"	24"	25"	26**	27"	28**	29"	30**	31"	32**	33"	34**	35"	36**
16"	\$424.37	\$450.90	\$477.42	\$503.94	\$530.47	\$556.99	\$583.51	\$610.04	\$636.56	\$663.08	\$689.61	\$716.13	\$742.65	\$769.18	\$795.70	\$822.22	\$848.74	\$875.27	\$901.79	\$928.31	\$954.84
17	450.90	479.08	507.26	535.44	563.62	591.80	619.98	648.16	676.34	704.53	732.71	760.89	789.07	817.25	845.43	873.61	901.79	929.97	958.15	986.33	1,014.51
18	477.42	507.26	537.10	566.94	596.78	626.61	656.45	686.29	716.13	745.97	775.81	805.64	835.48	865.32	895.16	925.00	954.84	984.68	1,014.51	1,044.35	1,074.19
19	503.94	535.44	566.94	598.43	629.93	661.43	692.92	724.42	755.91	787.41	818.91	850.40	881.90	913.40	944.89	976.39	1,007.88	1,039.38	1,070.88	1,102.37	1,133.87
20	530.47	563.62	596.78	629.93	663.08	696.24	729.39	762.54	795.70	828.85	862.01	895.16	928.31	961.47	994.62	1,027.78	1,060.93	1,094.08	1,127.24	1,160.39	1,193.55
21	556.99	591.80	626.61	661.43	696.24	731.05	765.86	800.67	835.48	870.30	905.11	939.92	974.73	1,009.54	1,044.35	1,079.16	1,113.98	1,148.79	1,183.60	1,218.41	1,253.22
22	583.51	619.98	656.45	692.92	729.39	765.86	802.33	838.80	875.27	911.74	948.21	984.68	1,021.15	1,057.61	1,094.08	1,130.55	1,167.02	1,203.49	1,239.96	1,276.43	1,312.90
23	610.04	648.16	686.29	724.42	762.54	800.67	838.80	876.93	915.05	953.18	991.31	1,029.43	1,067.56	1,105.69	1,143.81	1,181.94	1,220.07	1,258.20	1,296.32	1,334.45	1,372.58
24	636.56	676.34	716.13	755.91	795.70	835.48	875.27	915.05	954.84	994.62	1,034.41	1,074.19	1,113.98	1,153.76	1,193.55	1,233.33	1,273.11	1,312.90	1,352.68	1,392.47	1,432.25
25	663.08	704.53	745.97	787.41	828.85	870.30	911.74	953.18	994.62	1,036.06	1,077.51	1,118.95	1,160.39	1,201.83	1,243.28	1,284.72	1,326.16	1,367.60	1,409.05	1,450.49	1,491.93
26	689.61	732.71	775.81	818.91	862.01	905.11	948.21	991.31	1,034.41	1,077.51	1,120.61	1,163.71	1,206.81	1,249.91	1,293.01	1,336.11	1,379.21	1,422.31	1,465.41	1,508.51	1,551.61
27	716.13	760.89	805.64	850.40	895.16	939.92	984.68	1,029.43	1,074.19	1,118.95	1,163.71	1,208.46	1,253.22	1,297.98	1,342.74	1,387.50	1,432.25	1,477.01	1,521.77	1,566.53	1,611.28
28	742.65	789.07	835.48	881.90	928.31	974.73	1,021.15	1,067.56	1,113.98	1,160.39	1,206.81	1,253.22	1,299.64	1,346.05	1,392.47	1,438.88	1,485.30	1,531.72	1,578.13	1,624.55	1,670.96
29	769.18	817.25	865.32	913.40	961.47	1,009.54	1,057.61	1,105.69	1,153.76	1,201.83	1,249.91	1,297.98	1,346.05	1,394.13	1,442.20	1,490.27	1,538.35	1,586.42	1,634.49	1,682.57	1,730.64
30*	795.70	845.43	895.16	944.89	994.62	1,044.35	1,094.08	1,143.81	1,193.55	1,243.28	1,293.01	1,342.74	1,392.47	1,442.20	1,491.93	1,541.66	1,591.39	1,641.12	1,690.85	1,740.59	1,790.32
31*	822.22	873.61	925.00	976.39	1,027.78	1,079.16	1,130.55	1,181.94	1,233.33	1,284.72	1,336.11	1,387.50	1,438.88	1,490.27	1,541.66	1,593.05	1,644.44	1,695.83	1,747.22	1,798.60	1,849.99
32*	848.74	901.79	954.84	1,007.88	1,060.93	1,113.98	1,167.02	1,220.07	1,273.11	1,326.16	1,379.21	1,432.25	1,485.30	1,538.35	1,591.39	1,644.44	1,697.48	1,750.53	1,803.58	1,856.62	1,909.67
33*	875.27	929.97	984.68	1,039.38	1,094.08	1,148.79	1,203.49	1,258.20	1,312.90	1,367.60	1,422.31	1,477.01	1,531.72	1,586.42	1,641.12	1,695.83	1,750.53	1,805.24	1,859.94	1,914.64	1,969.35
34*	901.79	958.15	1,014.51	1,070.88	1,127.24	1,183.60	1,239.96	1,296.32	1,352.68	1,409.05	1,465.41	1,521.77	1,578.13	1,634.49	1,690.85	1,747.22	1,803.58	1,859.94	1,916.30	1,972.66	2,029.02
35*	928.31	986.33	1,044.35	1,102.37	1,160.39	1,218.41	1,276.43	1,334.45	1,392.47	1,450.49	1,508.51	1,566.53	1,624.55	1,682.57	1,740.59	1,798.60	1,856.62	1,914.64	1,972.66	2,030.68	2,088.70
36*	954.84	1,014.51	1,074.19	1,133.87	1,193.55	1,253.22	1,312.90	1,372.58	1,432.25	1,491.93	1,551.61	1,611.28	1,670.96	1,730.64	1,790.32	1,849.99	1,909.67	1,969.35	2,029.02	2,088.70	2,148.38
38*	1,007.88	1,070.88	1,133.87	1,196.86	1,259.85	1,322.85	1,385.84	1,448.83	1,511.82	1,574.82	1,637.81	1,700.80	1,763.79	1,826.79	1,889.78	1,952.77	2,015.76	2,078.75	2,141.75	2,204.74	2,267.73
40*	1,060.93	1,127.24	1,193.55	1,259.85	1,326.16	1,392.47	1,458.78	1,525.08	1,591.39	1,657.70	1,724.01	1,790.32	1,856.62	1,922.93	1,989.24	2,055.55	2,121.85	2,188.16	2,254.47	2,320.78	2,387.09
42*	1,113.98	1,183.60	1,253.22	1,322.85	1,392.47	1,462.09	1,531.72	1,601.34	1,670.96	1,740.59	1,810.21	1,879.83	1,949.45	2,019.08	2,088.70	2,158.32	2,227.95	2,297.57	2,367.19	2,436.82	2,506.44
44*	1,167.02	1,239.96	1,312.90	1,385.84	1,458.78	1,531.72	1,604.65	1,677.59	1,750.53	1,823.47	1,896.41	1,969.35	2,042.29	2,115.22	2,188.16	2,261.10	2,334.04	2,406.98	2,479.92	2,552.86	2,625.79
46*	1,220.07	1,296.32	1,372.58	1,448.83	1,525.08	1,601.34	1,677.59	1,753.85	1,830.10	1,906.35	1,982.61	2,058.86	2,135.12	2,211.37	2,287.62	2,363.88	2,440.13	2,516.39	2,592.64	2,668.89	2,745.15
48*	1,273.11	1,352.68	1,432.25	1,511.82	1,591.39	1,670.96	1,750.53	1,830.10	1,909.67	1,989.24	2,068.81	2,148.38	2,227.95	2,307.52	2,387.09	2,466.66	2,546.22	2,625.79	2,705.36	2,784.93	2,864.50
50*	1,326.16	1,409.05	1,491.93	1,574.82	1,657.70	1,740.59	1,823.47	1,906.35	1,989.24	2,072.12	2,155.01	2,237.89	2,320.78	2,403.66	2,486.55	2,569.43	2,652.32	2,735.20	2,818.09	2,900.97	2,983.86
52*	1,379.21	1,465.41	1,551.61	1,637.81	1,724.01	1,810.21	1,896.41	1,982.61	2,068.81	2,155.01	2,241.21	2,327.41	2,413.61	2,499.81	2,586.01	2,672.21	2,758.41	2,844.61	2,930.81	3,017.01	3,103.21
54*	1,432.25	1,521.77	1,611.28	1,700.80	1,790.32	1,879.83	1,969.35	2,058.86	2,148.38	2,237.89	2,327.41	2,416.92	2,506.44	2,595.96	2,685.47	2,774.99	2,864.50	2,954.02	3,043.53	3,133.05	3,222.56
56*	1,485.30	1,578.13	1,670.96	1,763.79	1,856.62	1,949.45	2,042.29	2,135.12	2,227.95	2,320.78	2,413.61	2,506.44	2,599.27	2,692.10	2,784.93	2,877.76	2,970.59	3,063.43	3,156.26	3,249.09	3,341.92
58*	1,538.35	1,634.49	1,730.64	1,826.79	1,922.93	2,019.08	2,115.22	2,211.37	2,307.52	2,403.66	2,499.81	2,595.96	2,692.10	2,788.25	2,884.39	2,980.54	3,076.69	3,172.83	3,268.98	3,365.13	3,461.27
60*	1,591.39	1,690.85	1,790.32	1,889.78	1,989.24	2,088.70	2,188.16	2,287.62	2,387.09	2,486.55	2,586.01	2,685.47	2,784.93	2,884.39	2,983.86	3,083.32	3,182.78	3,282.24	3,381.70	3,481.17	3,580.63
61+	EMAIL FOR QUOTE																				

\*Oversize charges will apply

## PRICE AS LISTED



Brushed

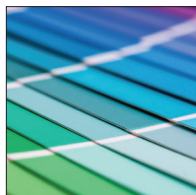

Painted

## OPTIONAL ANODIZED FINISHES - EMAIL FOR QUOTE



Clear



Champagne



Gold



Black



Light Bronze



Medium Bronze



Dark Bronze



## Your Logo 6" Deep Aluminum with Back

PRICE PER LOGO. Including standard mounting with pattern.

Logos smaller than 10" x 10" or with more than 3 pieces email for quote

Size	37"*	38"*	39"*	40"*	41"*	42"*	43"*	44"*	45"*	46"*	47"*	48"	49"*	50"	52"*	54"	56"*	58"	60"*
16"	\$981.36	\$1,007.88	\$1,034.41	\$1,060.93	\$1,087.45	\$1,113.98	\$1,140.50	\$1,167.02	\$1,193.55	\$1,220.07	\$1,246.59	\$1,273.11	\$1,299.64	\$1,326.16	\$1,379.21	\$1,432.25	\$1,485.30	\$1,538.35	\$1,591.39
17	1,042.70	1,070.88	1,099.06	1,127.24	1,155.42	1,183.60	1,211.78	1,239.96	1,268.14	1,296.32	1,324.50	1,352.68	1,380.87	1,409.05	1,465.41	1,521.77	1,578.13	1,634.49	1,690.85
18	1,104.03	1,133.87	1,163.71	1,193.55	1,223.38	1,253.22	1,283.06	1,312.90	1,342.74	1,372.58	1,402.42	1,432.25	1,462.09	1,491.93	1,551.61	1,611.28	1,670.96	1,730.64	1,790.32
19	1,165.36	1,196.86	1,228.36	1,259.85	1,291.35	1,322.85	1,354.34	1,385.84	1,417.33	1,448.83	1,480.33	1,511.82	1,543.32	1,574.82	1,637.81	1,700.80	1,763.79	1,826.79	1,889.78
20	1,226.70	1,259.85	1,293.01	1,326.16	1,359.32	1,392.47	1,425.62	1,458.78	1,491.93	1,525.08	1,558.24	1,591.39	1,624.55	1,657.70	1,724.01	1,790.32	1,856.62	1,922.93	1,989.24
21	1,288.03	1,322.85	1,357.66	1,392.47	1,427.28	1,462.09	1,496.90	1,531.72	1,566.53	1,601.34	1,636.15	1,670.96	1,705.77	1,740.59	1,810.21	1,879.83	1,949.45	2,019.08	2,088.70
22	1,349.37	1,385.84	1,422.31	1,458.78	1,495.25	1,531.72	1,568.18	1,604.65	1,641.12	1,677.59	1,714.06	1,750.53	1,787.00	1,823.47	1,896.41	1,969.35	2,042.29	2,115.22	2,188.16
23	1,410.70	1,448.83	1,486.96	1,525.08	1,563.21	1,601.34	1,639.47	1,677.59	1,715.72	1,753.85	1,791.97	1,830.10	1,868.23	1,906.35	1,982.61	2,058.86	2,135.12	2,211.37	2,287.62
24	1,472.04	1,511.82	1,551.61	1,591.39	1,631.18	1,670.96	1,710.75	1,750.53	1,790.32	1,830.10	1,869.89	1,909.67	1,949.45	1,989.24	2,068.81	2,148.38	2,227.95	2,307.52	2,387.09
25	1,533.37	1,574.82	1,616.26	1,657.70	1,699.14	1,740.59	1,782.03	1,823.47	1,864.91	1,906.35	1,947.80	1,989.24	2,030.68	2,072.12	2,155.01	2,237.89	2,320.78	2,403.66	2,486.55
26	1,594.71	1,637.81	1,680.91	1,724.01	1,767.11	1,810.21	1,853.31	1,896.41	1,939.51	1,982.61	2,025.71	2,068.81	2,111.91	2,155.01	2,241.21	2,327.41	2,413.61	2,499.81	2,586.01
27	1,656.04	1,700.80	1,745.56	1,790.32	1,835.07	1,879.83	1,924.59	1,969.35	2,014.10	2,058.86	2,103.62	2,148.38	2,193.14	2,237.89	2,327.41	2,416.92	2,506.44	2,595.96	2,685.47
28	1,717.38	1,763.79	1,810.21	1,856.62	1,903.04	1,949.45	1,995.87	2,042.29	2,088.70	2,135.12	2,181.53	2,227.95	2,274.36	2,320.78	2,413.61	2,506.44	2,599.27	2,692.10	2,784.93
29	1,778.71	1,826.79	1,874.86	1,922.93	1,971.00	2,019.08	2,067.15	2,115.22	2,163.30	2,211.37	2,259.44	2,307.52	2,355.59	2,403.66	2,499.81	2,595.96	2,692.10	2,788.25	2,884.39
30*	1,840.05	1,889.78	1,939.51	1,989.24	2,038.97	2,088.70	2,138.43	2,188.16	2,237.89	2,287.62	2,337.36	2,387.09	2,436.82	2,486.55	2,586.01	2,685.47	2,784.93	2,884.39	2,983.86
31*	1,901.38	1,952.77	2,004.16	2,055.55	2,106.94	2,158.32	2,209.71	2,261.10	2,312.49	2,363.88	2,415.27	2,466.66	2,518.04	2,569.43	2,672.21	2,774.99	2,877.76	2,980.54	3,083.32
32*	1,962.72	2,015.76	2,068.81	2,121.85	2,174.90	2,227.95	2,280.99	2,334.04	2,387.09	2,440.13	2,493.18	2,546.22	2,599.27	2,652.32	2,758.41	2,864.50	2,970.59	3,076.69	3,182.78
33*	2,024.05	2,078.75	2,133.46	2,188.16	2,242.87	2,297.57	2,352.27	2,406.98	2,461.68	2,516.39	2,571.09	2,625.79	2,680.50	2,735.20	2,844.61	2,954.02	3,063.43	3,172.83	3,282.24
34*	2,085.39	2,141.75	2,198.11	2,254.47	2,310.83	2,367.19	2,423.56	2,479.92	2,536.28	2,592.64	2,649.00	2,705.36	2,761.73	2,818.09	2,930.81	3,043.53	3,156.26	3,268.98	3,381.70
35*	2,146.72	2,204.74	2,262.76	2,320.78	2,378.80	2,436.82	2,494.84	2,552.86	2,610.88	2,668.89	2,726.91	2,784.93	2,842.95	2,900.97	3,017.01	3,133.05	3,249.09	3,365.13	3,481.17
36*	2,208.06	2,267.73	2,327.41	2,387.09	2,446.76	2,506.44	2,566.12	2,625.79	2,685.47	2,745.15	2,804.83	2,864.50	2,924.18	2,983.86	3,103.21	3,222.56	3,341.92	3,461.27	3,580.63
38*	2,330.72	2,393.72	2,456.71	2,519.70	2,582.69	2,645.69	2,708.68	2,771.67	2,834.66	2,897.66	2,960.65	3,023.64	3,086.63	3,149.63	3,275.61	3,401.60	3,527.58	3,653.57	3,779.55
40*	2,453.39	2,519.70	2,586.01	2,652.32	2,718.63	2,784.93	2,851.24	2,917.55	2,983.86	3,050.16	3,116.47	3,182.78	3,249.09	3,315.40	3,448.01	3,580.63	3,713.24	3,845.86	3,978.47
42*	2,576.06	2,645.69	2,715.31	2,784.93	2,854.56	2,924.18	2,993.80	3,063.43	3,133.05	3,202.67	3,272.30	3,341.92	3,411.54	3,481.17	3,620.41	3,759.66	3,898.90	4,038.15	4,177.40
44*	2,698.73	2,771.67	2,844.61	2,917.55	2,990.49	3,063.43	3,136.36	3,209.30	3,282.24	3,355.18	3,428.12	3,501.06	3,574.00	3,646.93	3,792.81	3,938.69	4,084.57	4,230.44	4,376.32
46*	2,821.40	2,897.66	2,973.91	3,050.16	3,126.42	3,202.67	3,278.93	3,355.18	3,431.43	3,507.69	3,583.94	3,660.20	3,736.45	3,812.70	3,965.21	4,117.72	4,270.23	4,422.74	4,575.24
48*	2,944.07	3,023.64	3,103.21	3,182.78	3,262.35	3,341.92	3,421.49	3,501.06	3,580.63	3,660.20	3,739.77	3,819.33	3,898.90	3,978.47	4,137.61	4,296.75	4,455.89	4,615.03	4,774.17
50*	3,066.74	3,149.63	3,232.51	3,315.40	3,398.28	3,481.17	3,564.05	3,646.93	3,729.82	3,812.70	3,895.59	3,978.47	4,061.36	4,144.24	4,310.01	4,475.78	4,641.55	4,807.32	4,973.09
52*	3,189.41	3,275.61	3,361.81	3,448.01	3,534.21	3,620.41	3,706.61	3,792.81	3,879.01	3,965.21	4,051.41	4,137.61	4,223.81	4,310.01	4,482.41	4,654.81	4,827.21	4,999.61	5,172.01
54*	3,312.08	3,401.60	3,491.11	3,580.63	3,670.14	3,759.66	3,849.17	3,938.69	4,028.20	4,117.72	4,207.24	4,296.75	4,386.27	4,475.78	4,654.81	4,833.84	5,012.88	5,191.91	5,370.94
56*	3,434.75	3,527.58	3,620.41	3,713.24	3,806.07	3,898.90	3,991.74	4,084.57	4,177.40	4,270.23	4,363.06	4,455.89	4,548.72	4,641.55	4,827.21	5,012.88	5,198.54	5,384.20	5,569.86
58*	3,557.42	3,653.57	3,749.71	3,845.86	3,942.00	4,038.15	4,134.30	4,230.44	4,326.59	4,422.74	4,518.88	4,615.03	4,711.18	4,807.32	4,999.61	5,191.91	5,384.20	5,576.49	5,768.78
60*	3,680.09	3,779.55	3,879.01	3,978.47	4,077.94	4,177.40	4,276.86	4,376.32	4,475.78	4,575.24	4,674.71	4,774.17	4,873.63	4,973.09	5,172.01	5,370.94	5,569.86	5,768.78	5,967.71
61+	EMAIL FOR QUOTE																		

\*Oversize charges will apply

### PRICE AS LISTED



Brushed

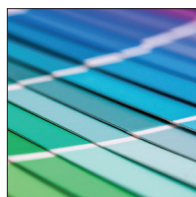

Painted

### OPTIONAL ANODIZED FINISHES - EMAIL FOR QUOTE



Clear

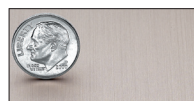

Champagne



Gold

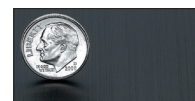

Black



Light Bronze



Medium Bronze



Dark Bronze



## **INTERIORS WITH EXCELLENCE**

Gemini's precision CNC & laser cutting lets you apply many of our finished aluminum and acrylic faces with our proprietary lamination process to durable and economical high density foam featuring a ABS backer.



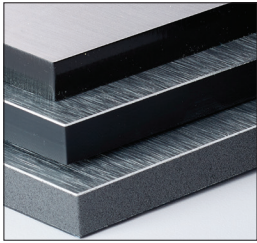

**UNIQUE LOOKS FOR INTERIORS**

From exhibits and retail displays to lobby reception areas, your interior signage and experiential branding projects will stand out with elegant laminate display letters that artfully infuse metals, ACRYLICs and specialty materials.



**GEMLEAF LETTERS & LOGOS**

Minimum Height	Maximum Height	Maximum Size	Depth/Thickness	Application	Material
1"	22"	22" X 46"; larger sizes available as multi-piece	5 thicknesses: 1/8", 3/16", 1/4", 3/8" & 1/2" based on letter height	Indoor ONLY	Acrylic and metal foils



**METAL ON ACRYLIC LETTERS & LOGOS**

Minimum Height	Maximum Height	Maximum Size	Depth/Thickness	Application	Material
3"	46"	46" X 95"; larger sizes available as multi-piece	8 thicknesses: 1/8", 3/16", 1/4", 3/8", 1/2", 3/4", 1" & 1-1/2" based on letter height	Indoor ONLY	Acrylic and metal laminates



**METAL OR ACRYLIC ON FOAM LETTERS & LOGOS**

Minimum Height	Maximum Height	Maximum Size	Depth/Thickness	Application	Material
4"	25"	46" X 46"; larger sizes available as multi-piece	6 thicknesses: 1/2", 3/4", 1" 1-1/2", 2" & 3" based on letter height	Indoor ONLY	Acrylic or metal laminate on foam



# Standard Fonts

Adrianna Bold	<b>ABCDEFGF abc 123</b>	ClearviewOne-Bold	<b>ABCDEFGF abc 123</b>
Adrianna Demibold	<b>ABCDEFGF abc 123</b>	Comic Sans Bold	<b>ABCDEFGF abc 123</b>
Adrianna Extrabold	<b>ABCDEFGF abc 123</b>	Commercial Script	<i>ABCDEFGF abc 123</i>
Americana Bold	<b>ABCDEFGF abc 123</b>	Consort	<b>ABCDEFGF abc 123</b>
Antique Olive Medium	<b>ABCDEFGF abc 123</b>	Consort Condensed	<b>ABCDEFGF abc 123</b>
Architectural	<b>ABCDEFGF abc 123</b>	Cooper Black	<b>ABCDEFGF abc 123</b>
Arial	<b>ABCDEFGF abc 123</b>	Cooper Black Italic	<b>ABCDEFGF 123</b>
Arial Bold	<b>ABCDEFGF 123</b>	Copperplate	<b>ABCDEFGF 123</b>
Avant Extra Bold	<b>ABCDEFGF abc 123</b>	Craw Clarendon Condensed	<b>ABCDEFGF abc 123</b>
Avant Garde Medium	<b>ABCDEFGF abc 123</b>	Eurostyle Bold Extended	<b>ABCDEFGF 123</b>
Barnum	<b>ABCDEFGF 123</b>	Eurostyle Bold Extended Italic	<b>ABCDEFGF 123</b>
Barnum Classic	<b>ABCDEFGF 123</b>	Fairbanks	<b>ABCDEFGF abc 123</b>
Bauhaus	<b>ABCDEFGF abc 123</b>	Forward Thinking	<b>ABCDEFGF abc 123</b>
Benguiat	<b>ABCDEFGF abc 123</b>	Friz Quadrata	<b>ABCDEFGF abc 123</b>
Bodoni Condensed	<b>ABCDEFGF 123</b>	Frutiger 65	<b>ABCDEFGF abc 123</b>
Bodoni Italic	<b>ABCDEFGF abc 123</b>	Futura	<b>ABCDEFGF abc 123</b>
Brush Script	<i>ABCDEFGF abc 123</i>	Futura Demi Bold	<b>ABCDEFGF abc 123</b>
Caslon Adbold	<b>ABCDEFGF 123</b>	Futura Bold	<b>ABCDEFGF abc 123</b>
Casual Italic Script	<i>ABCDEFGF abc 123</i>	Futura Condensed	<b>ABCDEFGF abc 123</b>
Century Schoolbook Bold	<b>ABCDEFGF 123</b>	Futura Extra Bold Italic	<b>ABCDEFGF abc 123</b>
Century Bold Condensed	<b>ABCDEFGF abc 123</b>	Garamond Book	<b>ABCDEFGF abc 123</b>
Clarendon Fortune Bold	<b>ABCDEFGF abc 123</b>	Garamond Regular	<b>ABCDEFGF abc 123</b>
Clarendon Medium	<b>ABCDEFGF 123</b>	Garamond Italic	<i>ABCDEFGF abc 123</i>
Clarion	<b>ABCDEFGF 123</b>	Garamond Bold	<b>ABCDEFGF abc 123</b>
ClearviewOne-Light	<b>ABCDEFGF abc 123</b>	Garamond Bold Italic	<i>ABCDEFGF abc 123</i>
		Gil Sans Bold	<b>ABCDEFGF abc 123</b>

Goudy Extra Bold	<b>ABCDEFGH abc 123</b>	Roffe	ABCDEFGH 123
Goudy Old Style	ABCDEFGH abc 123	Roman	<b>ABCDEFGH abc 123</b>
Helvetica	<b>ABCDEFGH abc 123</b>	Roman Classic	<b>ABCDEFGH 123</b>
Helvetica Light	ABCDEFGH 123	Roman Neo SB	<b>ABCDEFGH 123</b>
Helvetica Medium Italic	<i>ABCDEFGH abc 123</i>	Sculptured	<b>ABCDEFGH</b>
Helvetica Bold	<b>ABCDEFGH abc 123</b>	Shopaganda Condensed	<b>ABCDEFGH abc 123</b>
Helvetica Medium Condensed	<b>ABCDEFGH abc 123</b>	Shopaganda Regular	<b>ABCDEFGH abc 123</b>
Helvetica Bold Extended	<b>ABCDEFGH abc 123</b>	Standard Block	<b>ABCDEFGH abc 123</b>
Herman Italic	<i>ABCDEFGH abc 123</i>	Standard Block Condensed	<b>ABCDEFGH 123</b>
Hydropower Extracondensed	<b>ABCDEFGH abc 123</b>	Stettler	ABCDEFGH 123
Impact	<b>ABCDEFGH abc 123</b>	Timeless Geometric	<b>ABCDEFGH abc 123</b>
Italicized Script	<i>ABCDEFGH abc 123</i>	Times Bold	<b>ABCDEFGH abc 123</b>
Kabel	<b>ABCDEFGH 123</b>	Times Bold Italic	<i>ABCDEFGH abc 123</i>
Kegger	<b>ABCDEFGH abc 123</b>	Times New Roman	ABCDEFGH abc 123
Lithos Bold	<b>ABCDEFGH 123</b>	Times New Roman Italic	<i>ABCDEFGH abc 123</i>
Microgramma Extended	<b>ABCDEFGH 123</b>	Times Roman	ABCDEFGH abc 123
Microgramma Bold Extended	<b>ABCDEFGH 123</b>	Trajan Bold	ABCDEFGH 123
Old English	<i>ABCDEFGH abc 123</i>	Twentieth Century	<b>ABCDEFGH 123</b>
Optima	ABCDEFGH abc 123	Univers 67	<b>ABCDEFGH abc 123</b>
Optima Semi Bold	<b>ABCDEFGH abc 123</b>	University Roman	ABCDEFGH abc 123
Palatino	ABCDEFGH abc 123	University Roman Bold	ABCDEFGH abc 123
Palatino Bold	<b>ABCDEFGH abc 123</b>	Venus	<b>ABCDEFGH 123</b>
Palatino Semi Bold	<b>ABCDEFGH 123</b>		
Ribbon	ABCDEFGH 123		
Ribbon Condensed	ABCDEFGH 123		

**CLICK HERE TO  
DOWNLOAD  
FONTS**





## PRECISE DETAIL AND SOPHISTICATION

Gemini's custom laser cutting capabilities provide you with the ability to cut acrylic into shapes and letter styles not attainable with routers.





# GEMLEAF LAMINATE

Superior laser cut  
edges

47 standard substrate  
colors

Letters and logos  
from 1 inch to 22  
inches

5 standard thicknesses

Industry-leading  
lead times

## INTERIORS WITH IMPACT

With GemLeaf™ laminates, you can create interior signage designs with detail you would not think possible, with an affordable rich metallic finish. Your 2D letters and logos can be produced into dimensional shapes that will make your customers take notice. Using the latest technology, we apply a thin, micron metal face laminate to acrylic for a distinctive look at a lower cost and lighter weight than dimensional metal. And we offer special pricing on multiple sets that will reduce your costs further on large projects.











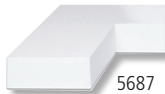
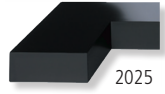



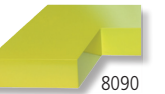









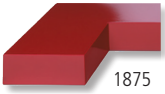
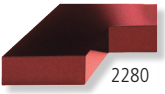
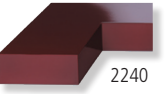

















### WHEN ORDERING

PLEASE SPECIFY:

- Install Environment
- Size (Height)
- Finish & Substrate Color
- Vector Art or Standard Font
- Thickness
- Install Method

## Edge Colors:

### BEST VALUE

 5687 White Approx PMS White	 2025 Black Approx PMS Black	 2718 Ivory Approx PMS 7499	 4660 Desert Sand Approx PMS 7506	 0209 Grey Approx PMS 423	 4310 Dove Grey Approx PMS 431	 8090 Safety Green Approx PMS 809	 2037 Lemon Yellow Approx PMS 102
 2000 Yellow Approx PMS 108	 0217 Citrus Yellow Approx PMS 606	 0218 Sundance Yellow Approx PMS 116	 0254 Mango Approx PMS 137	 2119 Orange Approx PMS 21	 2662 Red-Orange Approx PMS 485	 0256 Rampart Orange Approx PMS 172	 2793 Red Approx PMS 185
 1875 Brick Red Approx PMS 7623	 2280 Black Cherry Approx PMS 1817	 2240 Maroon Approx PMS 202	 2410 Magenta Approx PMS 241	 2287 Purple Approx PMS 2695	 0246 Violet Toner Approx PMS 2725	 2767 Midnight Blue Approx PMS 5395	 2050 Dark Blue Approx PMS 281
 2860 Medium Blue Approx PMS 286	 3000 Blue Approx PMS 300	 2648 Light Blue Approx PMS 2995	 5425 Marine Reef Blue Approx PMS 5425	 3210 Teal Blue Approx PMS 321	 3555 Spring Green Approx PMS 355	 0222 Emerald Green Approx PMS 356	 0259 Federal Green Approx PMS 350
 2108 Light Green Approx PMS 3415	 2030 Dark Green Approx PMS 3435	 2162 Hunter Green Approx PMS 3308	 0400 Brilliant Gold Approx PMS 7556	 2756 Metallic Gold* Approx PMS 465	 0401 Aztec Gold Approx PMS 2317	 0253 Copper Approx PMS 7600	 0402 Aztec Copper Approx PMS 7599
 2418 Brown Approx PMS 476	 0312 Medium Bronze* Approx PMS 2335	 0314 Old Copper* Approx PMS 2334	 3130 Duranodic Bronze* Approx PMS 2336	 1315 Dark Oxide Approx PMS 447	 8886 Metallic Silver* Approx PMS 3435		

### Custom Paint Color:

It's easy to request custom color matching! Simply tell us the paint number or name and brand of paint you'd like us to match (e.g. PMS 186 or Sherwin-Williams Boathouse Blue) and we will obtain a mixing formula at no cost to you.

Don't have a paint name or number and still need a color exactly matched? Please send us a sample (sample item must be at least 3" x 3") and our paint lab will run it through an exacting color match process. Exact color matching from a sample is \$200.

Face Finishes:



Brushed Aluminum



Polished Aluminum



Brushed Silver



Brushed Pewter



Brushed Brass



Polished Brass

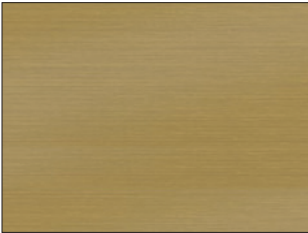

Brushed Bronze

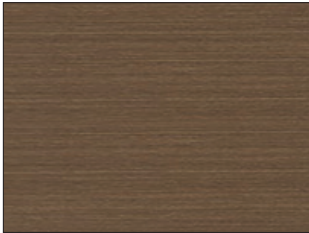

Brushed Medium Bronze

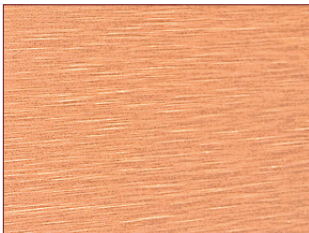

Brushed Copper

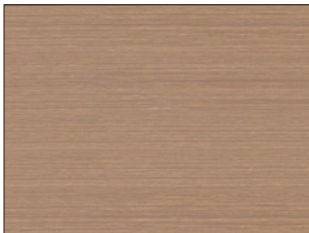

Brushed Bright Copper



Cherry



Royal Mahogany

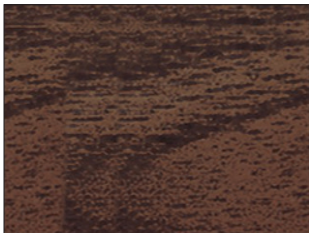

Walnut



Black Walnut



## Mounting Options:



### Plain

Letters and logos are supplied with no mounting holes or hardware. Price as listed.

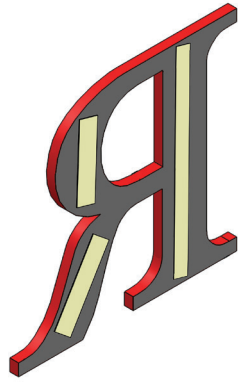

### Double Face Tape

Strips of 25mm VHB tape applied to backs of letters and logos. Maximum size varies by thickness of material. Price as listed.

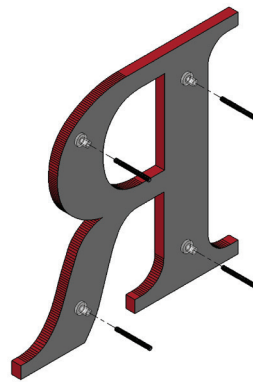

### Stud with Block

Backs of letters and logos have plastic drilled & tapped blocks glued to the back to receive threaded studs. Optional alignment for brick, block or rails. Price as listed.



### Flush Stud

Backs of letters and logos, at least 1/4" thick, are drilled and tapped to receive threaded studs, for mounting to wall. Optional alignment for brick, block or rails. Price as listed.



### Full Coverage D/F Tape

Letters and logos 4" and under can have the full coverage double face tape. Call for quote.

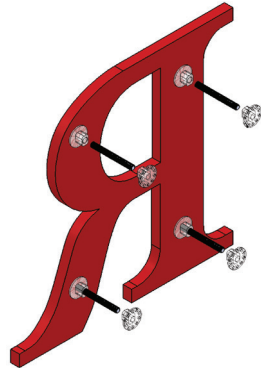

### Combination All

Same as stud mount above except adjustable pads are supplied to provide extra adhesion to mounting surface.

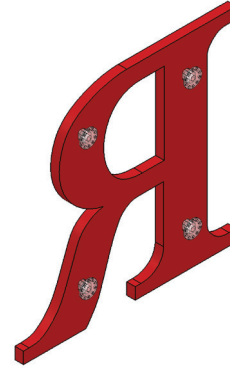

### Pad

Backs of letters and logos have plastic pads glued to the back. Optional alignment for rails.



# 1/8", 3/16", 1/4" & 1/2" Thick GemLeaf on Acrylic Letters

**PRICE PER LETTER - Includes standard mounting and pattern**

SIZE	1/8" or 3/16" THICK		1/4" THICK		3/8" THICK		1/2" THICK	
	BLACK OR PLATINUM EDGE	PAINTED EDGE	BLACK OR PLATINUM EDGE	PAINTED EDGE	BLACK OR PLATINUM EDGE	PAINTED EDGE	BLACK OR PLATINUM EDGE	PAINTED EDGE
1"	\$9.70	\$11.16	\$11.50	\$13.23	\$14.20	\$16.33	\$17.60	\$20.24
2	11.50	13.23	13.50	15.53	19.60	22.54	24.20	27.83
3	12.30	14.15	15.70	18.06	25.00	28.75	27.90	32.09
4	13.10	15.07	18.60	21.39	29.70	34.16	32.90	37.84
5	14.60	16.79	19.80	22.77	33.90	38.99	37.20	42.78
6	16.20	18.63	22.30	25.65	37.70	43.36	42.10	48.42
7	19.00	21.85	27.30	31.40	42.40	48.76	47.90	55.09
8	22.00	25.30	32.20	37.03	47.20	54.28	56.30	64.75
9	26.40	30.36	37.90	43.59	52.40	60.26	65.50	75.33
10	31.40	36.11	43.90	50.49	58.80	67.62	73.90	84.99
11	35.70	41.06	49.40	56.81	65.60	75.44	82.80	95.22
12	40.50	46.58	55.20	63.48	73.50	84.53	93.60	107.64
13	45.20	51.98	61.90	71.19	83.50	96.03	105.80	121.67
14	50.30	57.85	71.50	82.23	95.70	110.06	118.30	136.05
15	55.20	63.48	78.60	90.39	107.70	123.86	131.60	151.34
16	60.80	69.92	86.60	99.59	119.80	137.77	143.50	165.03
17	65.40	75.21	94.60	108.79	130.70	150.31	156.40	179.86
18	71.30	82.00	102.80	118.22	143.30	164.80	169.90	195.39
19	77.00	88.55	110.90	127.54	156.50	179.98	184.60	212.29
20	85.50	98.33	118.60	136.39	171.70	197.46	200.70	230.81
21	94.20	108.33	128.20	147.43	187.50	215.63	218.30	251.05
22	102.20	117.53	146.70	168.71	204.10	234.72	236.60	272.09

LETTER HEIGHT - MAX DIMENSION

**Pricing Notes:**

- Price includes either plain, stud or double face tape mount and installation pattern / stencil
- Stud mount on 1/8" material will have a 3/8" stand-off
- Stud mount on 1/4" and greater material will be flush (drilled and tapped)
- Lower case is 75% of the corresponding Upper Case price
- Small punctuation, such as a comma, period and dash are 33% of the Upper Case price
- To see pricing for additional finishes and mounting options see the Comprehensive Product & Pricing Guide



## 1/8" or 3/16" Thick - GemLeaf with Black or Platinum Edge Logo

### PRICE PER LOGO - Includes standard mounting and pattern

SIZE	10"	11"	12"	13"	14"	15"	16"	17"	18"	19"	20"	21"	22"
10"	\$52.10	\$56.60	\$59.70	\$63.00	\$66.10	\$67.90	\$71.30	\$74.40	\$78.80	\$87.40	\$94.50	\$100.30	\$104.80
11	56.60	61.50	65.10	69.00	72.50	76.10	79.80	82.00	87.10	96.00	103.70	110.00	114.90
12	59.70	65.10	70.60	74.70	78.80	82.90	85.70	88.50	95.10	104.60	112.70	119.30	124.70
13	63.00	69.00	74.70	80.70	85.20	88.30	91.70	96.20	103.30	113.10	121.70	128.90	134.60
14	66.10	72.50	78.80	85.20	91.50	95.00	98.80	102.40	111.30	121.80	130.60	138.40	144.80
15	67.90	76.10	82.90	88.30	95.00	101.90	106.00	110.10	119.40	130.10	139.70	147.80	154.50
16	71.30	79.80	85.70	91.70	98.80	106.00	113.20	117.90	127.70	138.80	148.70	157.30	164.50
17	74.40	82.00	88.50	96.20	102.40	110.10	117.90	125.40	135.90	147.60	157.70	166.80	174.50
18	78.80	87.10	95.10	103.30	111.30	119.40	127.70	135.90	143.90	156.20	166.80	176.40	184.30
19	87.40	96.00	104.60	113.10	121.80	130.10	138.80	147.60	156.20	164.70	175.70	185.80	194.50
20	94.50	103.70	112.70	121.70	130.60	139.70	148.70	157.70	166.80	175.70	184.80	195.20	204.30
21	100.30	110.00	119.30	128.90	138.40	147.80	157.30	166.80	176.40	185.80	195.20	204.70	214.20
22	104.80	114.90	124.70	134.60	144.80	154.50	164.50	174.50	184.30	194.50	204.30	214.20	224.20

**LOGOS SMALLER THAN 10" X 10" CAN BE PRICED AS A LETTER USING THE MAXIMUM DIMENSION  
 LOGOS LARGER THAN SIZES SHOWN OR CONTAINING 31+ PIECES/CUTOUTS  
 EMAIL: [Signage@GeminiMade.com](mailto:Signage@GeminiMade.com)**

## 1/8" or 3/16" Thick - GemLeaf with Painted Edge Logo

### PRICE PER LOGO - Includes standard mounting and pattern

SIZE	10"	11"	12"	13"	14"	15"	16"	17"	18"	19"	20"	21"	22"
10"	\$59.92	\$65.09	\$68.66	\$72.45	\$76.02	\$78.09	\$82.00	\$85.56	\$90.62	\$100.51	\$108.68	\$115.35	\$120.52
11	65.09	70.73	74.87	79.35	83.38	87.52	91.77	94.30	100.17	110.40	119.26	126.50	132.14
12	68.66	74.87	81.19	85.91	90.62	95.34	98.56	101.78	109.37	120.29	129.61	137.20	143.41
13	72.45	79.35	85.91	92.81	97.98	101.55	105.46	110.63	118.80	130.07	139.96	148.24	154.79
14	76.02	83.38	90.62	97.98	105.23	109.25	113.62	117.76	128.00	140.07	150.19	159.16	166.52
15	78.09	87.52	95.34	101.55	109.25	117.19	121.90	126.62	137.31	149.62	160.66	169.97	177.68
16	82.00	91.77	98.56	105.46	113.62	121.90	130.18	135.59	146.86	159.62	171.01	180.90	189.18
17	85.56	94.30	101.78	110.63	117.76	126.62	135.59	144.21	156.29	169.74	181.36	191.82	200.68
18	90.62	100.17	109.37	118.80	128.00	137.31	146.86	156.29	165.49	179.63	191.82	202.86	211.95
19	100.51	110.40	120.29	130.07	140.07	149.62	159.62	169.74	179.63	189.41	202.06	213.67	223.68
20	108.68	119.26	129.61	139.96	150.19	160.66	171.01	181.36	191.82	202.06	212.52	224.48	234.95
21	115.35	126.50	137.20	148.24	159.16	169.97	180.90	191.82	202.86	213.67	224.48	235.41	246.33
22	120.52	132.14	143.41	154.79	166.52	177.68	189.18	200.68	211.95	223.68	234.95	246.33	257.83

## 1/4" Thick - GemLeaf with Black or Platinum Edge Logo

### PRICE PER LOGO - Includes standard mounting and pattern

SIZE	10"	11"	12"	13"	14"	15"	16"	17"	18"	19"	20"	21"	22"
10"	\$60.60	\$66.00	\$69.90	\$74.00	\$78.00	\$80.70	\$84.70	\$88.80	\$94.20	\$103.40	\$111.50	\$118.30	\$123.60
11	66.00	71.90	76.50	80.90	84.20	88.80	93.30	96.60	103.80	113.70	122.30	129.50	135.30
12	69.90	76.50	82.80	88.10	93.10	96.90	100.50	104.30	113.50	123.90	133.00	141.00	147.40
13	74.00	80.90	88.10	94.90	100.50	104.80	109.30	113.50	123.00	134.00	143.80	152.00	159.00
14	78.00	84.20	93.10	100.50	107.90	112.90	117.90	122.50	132.80	144.20	154.40	163.20	170.80
15	80.70	88.80	96.90	104.80	112.90	121.00	126.40	131.70	142.40	154.40	165.10	174.50	182.60
16	84.70	93.30	100.50	109.30	117.90	126.40	135.00	141.00	152.00	164.70	175.80	185.80	194.50
17	88.80	96.60	104.30	113.50	122.50	131.70	141.00	150.00	161.80	174.90	186.60	197.20	206.20
18	94.20	103.80	113.50	123.00	132.80	142.40	152.00	161.80	171.40	184.90	197.40	208.30	218.00
19	103.40	113.70	123.90	134.00	144.20	154.40	164.70	174.90	184.90	195.20	208.00	219.50	229.70
20	111.50	122.30	133.00	143.80	154.40	165.10	175.80	186.60	197.40	208.00	218.70	230.80	241.60
21	118.30	129.50	141.00	152.00	163.20	174.50	185.80	197.20	208.30	219.50	230.80	319.50	253.50
22	123.60	135.30	147.40	159.00	170.80	182.60	194.50	206.20	218.00	229.70	241.60	253.50	265.10

**LOGOS SMALLER THAN 10" X 10" CAN BE PRICED AS A LETTER USING THE MAXIMUM DIMENSION**  
**LOGOS LARGER THAN SIZES SHOWN OR CONTAINING 31+ PIECES/CUTOUTS**  
**EMAIL: [Signage@GeminiMade.com](mailto:Signage@GeminiMade.com)**

## 1/4" Thick - GemLeaf with Painted Edge Logo

### PRICE PER LOGO - Includes standard mounting and pattern

SIZE	10"	11"	12"	13"	14"	15"	16"	17"	18"	19"	20"	21"	22"
10"	\$69.69	\$75.90	\$80.39	\$85.10	\$89.70	\$92.81	\$97.41	\$102.12	\$108.33	\$118.91	\$128.23	\$136.05	\$142.14
11	75.90	82.69	87.98	93.04	96.83	102.12	107.30	111.09	119.37	130.76	140.65	148.93	155.60
12	80.39	87.98	95.22	101.32	107.07	111.44	115.58	119.95	130.53	142.49	152.95	162.15	169.51
13	85.10	93.04	101.32	109.14	115.58	120.52	125.70	130.53	141.45	154.10	165.37	174.80	182.85
14	89.70	96.83	107.07	115.58	124.09	129.84	135.59	140.88	152.72	165.83	177.56	187.68	196.42
15	92.81	102.12	111.44	120.52	129.84	139.15	145.36	151.46	163.76	177.56	189.87	200.68	209.99
16	97.41	107.30	115.58	125.70	135.59	145.36	155.25	162.15	174.80	189.41	202.17	213.67	223.68
17	102.12	111.09	119.95	130.53	140.88	151.46	162.15	172.50	186.07	201.14	214.59	226.78	237.13
18	108.33	119.37	130.53	141.45	152.72	163.76	174.80	186.07	197.11	212.64	227.01	239.55	250.70
19	118.91	130.76	142.49	154.10	165.83	177.56	189.41	201.14	212.64	224.48	239.20	252.43	264.16
20	128.23	140.65	152.95	165.37	177.56	189.87	202.17	214.59	227.01	239.20	251.51	265.42	277.84
21	136.05	148.93	162.15	174.80	187.68	200.68	213.67	226.78	239.55	252.43	265.42	367.43	291.53
22	142.14	155.60	169.51	182.85	196.42	209.99	223.68	237.13	250.70	264.16	277.84	291.53	304.87

### 3/8" Thick - GemLeaf with Black or Platinum Edge Logo

**PRICE PER LOGO - Includes standard mounting and pattern**

SIZE	10"	11"	12"	13"	14"	15"	16"	17"	18"	19"	20"	21"	22"
10"	\$66.40	\$72.90	\$79.70	\$86.20	\$92.80	\$99.40	\$106.10	\$112.80	\$119.30	\$126.00	\$132.60	\$139.30	\$145.80
11	72.90	80.30	87.40	94.90	102.10	109.40	116.70	123.90	131.30	138.60	145.80	153.20	160.50
12	79.70	87.40	95.40	103.50	111.30	119.30	127.30	135.20	143.20	151.20	159.10	167.00	175.00
13	86.20	94.90	103.50	112.00	120.70	129.40	138.00	146.50	155.00	163.70	172.40	181.00	189.60
14	92.80	102.10	111.30	120.70	130.00	139.30	148.50	157.70	167.00	176.40	185.70	194.80	204.20
15	99.40	109.40	119.30	129.40	139.30	149.20	159.10	169.00	179.00	189.00	198.90	208.90	218.70
16	106.10	116.70	127.30	138.00	148.50	159.10	169.70	180.30	191.00	201.50	212.20	222.90	233.40
17	112.80	123.90	135.20	146.50	157.70	169.00	180.30	191.50	202.90	214.20	225.40	236.60	247.90
18	119.30	131.30	143.20	155.00	167.00	179.00	191.00	202.90	214.80	226.70	238.60	250.60	262.50
19	126.00	138.60	151.20	163.70	176.40	189.00	201.50	214.20	226.70	239.30	251.80	264.40	277.10
20	132.60	145.80	159.10	172.40	185.70	198.90	212.20	225.40	238.60	251.80	265.10	278.50	291.70
21	139.30	153.20	167.00	181.00	194.80	208.90	222.90	236.60	250.60	264.40	278.50	292.40	306.30
22	145.80	160.50	175.00	189.60	204.20	218.70	233.40	247.90	262.50	277.10	291.70	306.30	320.80

**LOGOS SMALLER THAN 10" X 10" CAN BE PRICED AS A LETTER USING THE MAXIMUM DIMENSION  
LOGOS LARGER THAN SIZES SHOWN OR CONTAINING 31+ PIECES/CUTOUTS  
EMAIL: [Signage@GeminiMade.com](mailto:Signage@GeminiMade.com)**

### 3/8" Thick - GemLeaf with Painted Edge Logo

**PRICE PER LOGO - Includes standard mounting and pattern**

SIZE	10"	11"	12"	13"	14"	15"	16"	17"	18"	19"	20"	21"	22"
10"	\$76.36	\$83.84	\$91.66	\$99.13	\$106.72	\$114.31	\$122.02	\$129.72	\$137.20	\$144.90	\$152.49	\$160.20	\$167.67
11	83.84	92.35	100.51	109.14	117.42	125.81	134.21	142.49	151.00	159.39	167.67	176.18	184.58
12	91.66	100.51	109.71	119.03	128.00	137.20	146.40	155.48	164.68	173.88	182.97	192.05	201.25
13	99.13	109.14	119.03	128.80	138.81	148.81	158.70	168.48	178.25	188.26	198.26	208.15	218.04
14	106.72	117.42	128.00	138.81	149.50	160.20	170.78	181.36	192.05	202.86	213.56	224.02	234.83
15	114.31	125.81	137.20	148.81	160.20	171.58	182.97	194.35	205.85	217.35	228.74	240.24	251.51
16	122.02	134.21	146.40	158.70	170.78	182.97	195.16	207.35	219.65	231.73	244.03	256.34	268.41
17	129.72	142.49	155.48	168.48	181.36	194.35	207.35	220.23	233.34	246.33	259.21	272.09	285.09
18	137.20	151.00	164.68	178.25	192.05	205.85	219.65	233.34	247.02	260.71	274.39	288.19	301.88
19	144.90	159.39	173.88	188.26	202.86	217.35	231.73	246.33	260.71	275.20	289.57	304.06	318.67
20	152.49	167.67	182.97	198.26	213.56	228.74	244.03	259.21	274.39	289.57	304.87	320.28	335.46
21	160.20	176.18	192.05	208.15	224.02	240.24	256.34	272.09	288.19	304.06	320.28	336.26	352.25
22	167.67	184.58	201.25	218.04	234.83	251.51	268.41	285.09	301.88	318.67	335.46	352.25	368.92



## 1/2" Thick - GemLeaf with Black or Platinum Edge Logo

### PRICE PER LOGO - Includes standard mounting and pattern

SIZE	10"	11"	12"	13"	14"	15"	16"	17"	18"	19"	20"	21"	22"
10"	\$82.90	\$91.30	\$99.40	\$107.70	\$116.10	\$124.40	\$132.60	\$141.00	\$149.20	\$157.40	\$165.70	\$174.10	\$182.30
11	91.30	100.30	109.40	118.50	127.70	136.80	145.80	154.90	164.10	173.30	182.30	191.40	200.60
12	99.40	109.40	119.30	129.40	139.30	149.20	159.10	169.00	179.00	189.00	198.90	208.90	218.70
13	107.70	118.50	129.40	140.10	150.90	161.70	172.40	183.10	193.90	204.60	215.40	226.30	237.00
14	116.10	127.70	139.30	150.90	162.50	174.10	185.70	197.30	208.90	220.50	232.10	243.70	255.30
15	124.40	136.80	149.20	161.70	174.10	186.50	198.90	211.40	223.80	236.20	248.60	261.10	273.50
16	132.60	145.80	159.10	172.40	185.70	198.90	212.20	225.40	238.60	251.80	265.10	278.50	291.70
17	141.00	154.90	169.00	183.10	197.30	211.40	225.40	239.40	253.50	267.70	281.80	295.80	309.90
18	149.20	164.10	179.00	193.90	208.90	223.80	238.60	253.50	268.50	283.40	298.30	313.10	328.10
19	157.40	173.30	189.00	204.60	220.50	236.20	251.80	267.70	283.40	299.20	314.90	330.60	346.40
20	165.70	182.30	198.90	215.40	232.10	248.60	265.10	281.80	298.30	314.90	331.50	347.90	364.60
21	174.10	191.40	208.90	226.30	243.70	261.10	278.50	295.80	313.10	330.60	347.90	365.40	382.80
22	182.30	200.60	218.70	237.00	255.30	273.50	291.70	309.90	328.10	346.40	364.60	382.80	401.00

**LOGOS SMALLER THAN 10" X 10" CAN BE PRICED AS A LETTER USING THE MAXIMUM DIMENSION**  
**LOGOS LARGER THAN SIZES SHOWN OR CONTAINING 31+ PIECES/CUTOUTS**  
**EMAIL: [Signage@GeminiMade.com](mailto:Signage@GeminiMade.com)**

## 1/2" Thick - GemLeaf with Painted Edge Logo

### PRICE PER LOGO - Includes standard mounting and pattern

SIZE	10"	11"	12"	13"	14"	15"	16"	17"	18"	19"	20"	21"	22"
10"	\$95.34	\$105.00	\$114.31	\$123.86	\$133.52	\$143.06	\$152.49	\$162.15	\$171.58	\$181.01	\$190.56	\$200.22	\$209.65
11	105.00	115.35	125.81	136.28	146.86	157.32	167.67	178.14	188.72	199.30	209.65	220.11	230.69
12	114.31	125.81	137.20	148.81	160.20	171.58	182.97	194.35	205.85	217.35	228.74	240.24	251.51
13	123.86	136.28	148.81	161.12	173.54	185.96	198.26	210.57	222.99	235.29	247.71	260.25	272.55
14	133.52	146.86	160.20	173.54	186.88	200.22	213.56	226.90	240.24	253.58	266.92	280.26	293.60
15	143.06	157.32	171.58	185.96	200.22	214.48	228.74	243.11	257.37	271.63	285.89	300.27	314.53
16	152.49	167.67	182.97	198.26	213.56	228.74	244.03	259.21	274.39	289.57	304.87	320.28	335.46
17	162.15	178.14	194.35	210.57	226.90	243.11	259.21	275.31	291.53	307.86	324.07	340.17	356.39
18	171.58	188.72	205.85	222.99	240.24	257.37	274.39	291.53	308.78	325.91	343.05	360.07	377.32
19	181.01	199.30	217.35	235.29	253.58	271.63	289.57	307.86	325.91	344.08	362.14	380.19	398.36
20	190.56	209.65	228.74	247.71	266.92	285.89	304.87	324.07	343.05	362.14	381.23	400.09	419.29
21	200.22	220.11	240.24	260.25	280.26	300.27	320.28	340.17	360.07	380.19	400.09	420.21	440.22
22	209.65	230.69	251.51	272.55	293.60	314.53	335.46	356.39	377.32	398.36	419.29	440.22	461.15

▼ SAMSUNG: 3"H brushed aluminum on 1/8" thick black acrylic. W: 6"H brushed brass on 1/2" thick black acrylic. P: 8"H brushed medium bronze on 1/4" thick black acrylic.







## **A BEAUTIFUL COMBINATION**

Leading expertise in metals and manufacturing of our own acrylic sheets combine with a proprietary lamination process to produce unique letters and logos of exquisite detail and refinement.





# METAL ON ACRYLIC LAMINATE

Precision CNC cut edges

47 standard substrate colors

Letters and logos from 2 inch to 46 inches

8 standard thicknesses

Industry-leading lead times

## THE LOOK OF LUXURY

Gemini combines the colorful durability and elegance of our modified extruded acrylic substrates with .030 solid Chemetal sheets of genuine aluminum in your desired finish and metallic effect to produce a unique alternative to metal letters and logos. We fuse these dissimilar materials together with our patented Bern-Lok system using a combination of heat, high pressure, and chemical bonding that is guaranteed to last. Once laminated, we expertly and precisely router cut your design using our state-of-the-art CNC equipment and complete the fit and feel with edge finishing.











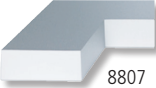



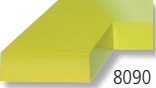





















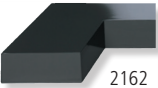

### WHEN ORDERING

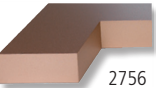
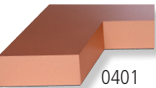
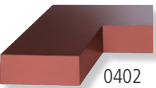
PLEASE SPECIFY:

- Install Environment
- Size (Height)
- Finish & Substrate Color
- Vector Art or Standard Font
- Thickness
- Install Method

## Edge Colors:

### BEST VALUE

 8807 Platinum Approx PMS 427	 2025 Black Approx PMS Black	 2718 Ivory Approx PMS 7499	 4660 Desert Sand Approx PMS 7506	 0209 Grey Approx PMS 423	 4310 Dove Grey Approx PMS 431	 8090 Safety Green Approx PMS 809	 2037 Lemon Yellow Approx PMS 102
 2000 Yellow Approx PMS 108	 0217 Citrus Yellow Approx PMS 606	 0218 Sundance Yellow Approx PMS 116	 0254 Mango Approx PMS 137	 2119 Orange Approx PMS 21	 2662 Red-Orange Approx PMS 485	 0256 Rampart Orange Approx PMS 172	 2793 Red Approx PMS 185
 1875 Brick Red Approx PMS 7623	 2280 Black Cherry Approx PMS 1817	 2240 Maroon Approx PMS 202	 2410 Magenta Approx PMS 241	 2287 Purple Approx PMS 2695	 0246 Violet Toner Approx PMS 2725	 2767 Midnight Blue Approx PMS 5395	 2050 Dark Blue Approx PMS 281
 2860 Medium Blue Approx PMS 286	 3000 Blue Approx PMS 300	 2648 Light Blue Approx PMS 2995	 5425 Marine Reef Blue Approx PMS 5425	 3210 Teal Blue Approx PMS 321	 3555 Spring Green Approx PMS 355	 0222 Emerald Green Approx PMS 356	 0259 Federal Green Approx PMS 350
 2108 Light Green Approx PMS 3415	 2030 Dark Green Approx PMS 3435	 2162 Hunter Green Approx PMS 3308	 0400 Brilliant Gold Approx PMS 7556	 2756 Metallic Gold* Approx PMS 465	 0401 Aztec Gold Approx PMS 2317	 0253 Copper Approx PMS 7600	 0402 Aztec Copper Approx PMS 7599
 2418 Brown Approx PMS 476	 0312 Medium Bronze* Approx PMS 2335	 0314 Old Copper* Approx PMS 2334	 3130 Duranodic Bronze* Approx PMS 2336	 1315 Dark Oxide Approx PMS 447	 8886 Metallic Silver* Approx PMS 3435	 5687 White Approx PMS White	

### Custom Paint Color:

It's easy to request custom color matching! Simply tell us the paint number or name and brand of paint you'd like us to match (e.g. PMS 186 or Sherwin-Williams Boathouse Blue) and we will obtain a mixing formula at no cost to you.

Don't have a paint name or number and still need a color exactly matched? Please send us a sample (sample item must be at least 3"x 3") and our paint lab will run it through an exacting color match process. Exact color matching from a sample is \$200.

**Standard Face Finishes:**

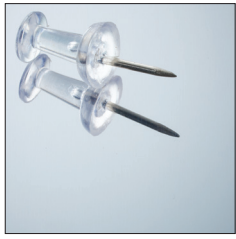

901  
Polished Aluminum



902  
Brushed Aluminum

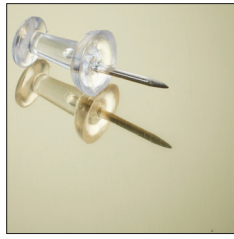

903  
Polished Brass



904  
Brushed Light Brass

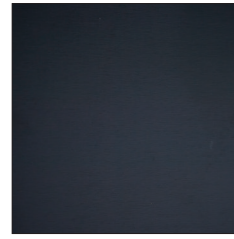

908  
Satin Black

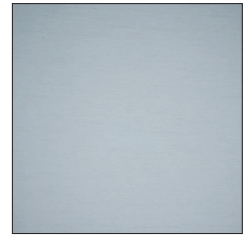

909  
Satin Silver



915  
Brushed Brass



916  
Brushed Pewter

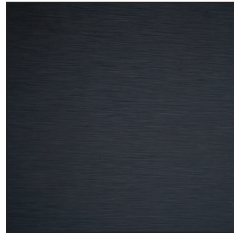

917  
Brushed Black



925  
Brushed Med. Bronze



927  
Light Stainless



906  
Brushed Copper Aluminum

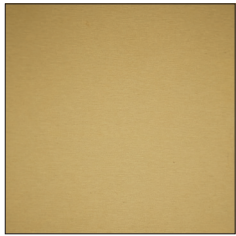

910  
Satin Gold Aluminum



924  
Bronze Stainless Aluminum



912  
Satin Bronze Aluminum



3102  
Rancho Walnut Veneer

**Special Order Finishes Also Available.**  
Email for Quote.

**CHEMETAL • treefrog • InteriorArts**  
or Your Specified Manufacturer

**Special Order CHEMETAL™ Face Finishes**  
Email for Quote

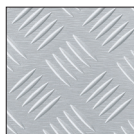

216  
Footplate



305  
Antique Brushed  
Brass Dark



310  
Antique Brass  
Brushed

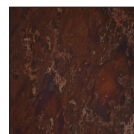

314  
Mayan

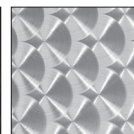

406  
Circles

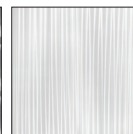

413  
Linear

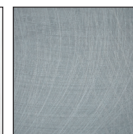

414  
Nomadic

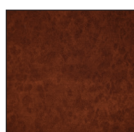

600  
Weathered  
Aluminum

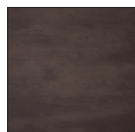

601  
Deep Bronze  
Aluminum



610  
Khaleesi  
Aluminum



613  
Ember Aluminum



614  
Beowulf Alumi-  
num

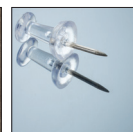

801  
Polished Chrome

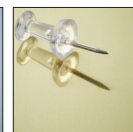

803  
Polished Solid  
Brass



804  
Satin Solid Brass



812  
Satin Smoked  
Chrome



## Mounting Options:



### Plain

Letters and logos are supplied with no mounting holes or hardware. Price as listed.



### Double Face Tape

Strips of 25mm VHB tape applied to backs of letters and logos. Maximum size varies by thickness of material. Price as listed.

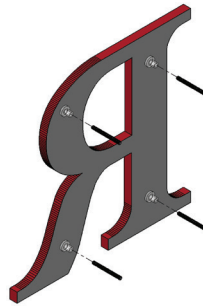

### Stud with Block

Backs of letters and logos have plastic drilled & tapped blocks glued to the back to receive threaded studs. Optional alignment for brick, block or rails. Price as listed.



### Flush Stud

Backs of letters and logos, at least 1/4" thick, are drilled and tapped to receive threaded studs, for mounting to wall. Optional alignment for brick, block or rails. Price as listed.



### Full Coverage D/F Tape

Letters and logos 4" and under can have the full coverage double face tape. Call for quote.

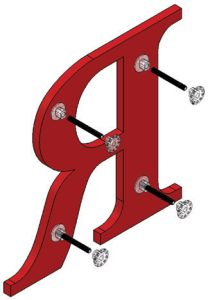

### Combination All

Same as stud mount above except adjustable pads are supplied to provide extra adhesion to mounting surface.



### Pad

Backs of letters and logos have plastic pads glued to the back. Optional alignment for rails.



# Metal Laminate on Acrylic Letters

## PRICE PER LETTER - Includes standard mounting and pattern

SIZE	1/8" or 3/16" THICK		1/4" THICK		3/8" THICK		1/2" THICK	
	BLACK OR		BLACK OR		BLACK OR		BLACK OR	
	PLATINUM EDGE	PAINTED EDGE	PLATINUM EDGE	PAINTED EDGE	PLATINUM EDGE	PAINTED EDGE	PLATINUM EDGE	PAINTED EDGE
3"	\$6.40	\$7.36	\$7.60	\$8.74	\$12.30	\$14.15	\$12.40	\$14.26
4	7.80	8.97	10.00	11.50	14.20	16.33	15.60	17.94
5	9.70	11.16	11.70	13.46	15.70	18.06	18.20	20.93
6	11.80	13.57	14.30	16.45	19.40	22.31	22.10	25.42
7	14.90	17.14	18.30	21.05	23.40	26.91	26.60	30.59
8	18.50	21.28	22.60	25.99	28.30	32.55	32.40	37.26
9	22.60	25.99	27.40	31.51	33.60	38.64	37.90	43.59
10	27.50	31.63	32.70	37.61	39.30	45.20	44.40	51.06
11	32.30	37.15	38.10	43.82	45.20	51.98	50.70	58.31
12	37.50	43.13	43.80	50.37	52.40	60.26	59.00	67.85
13	43.20	49.68	50.10	57.62	60.30	69.35	67.60	77.74
14	49.20	56.58	58.00	66.70	68.50	78.78	76.60	88.09
15	55.60	63.94	65.10	74.87	76.90	88.44	83.50	96.03
16	62.40	71.76	73.00	83.95	85.90	98.79	93.10	107.07
17	69.20	79.58	81.30	93.50	95.30	109.60	102.90	118.34
18	76.50	87.98	89.40	102.81	105.30	121.10	113.60	130.64
19	84.40	97.06	98.60	113.39	116.20	133.63	125.50	144.33
20	93.50	107.53	107.50	123.63	127.90	147.09	138.10	158.82
21	103.10	118.57	117.30	134.90	140.30	161.35	151.40	174.11
22	112.70	129.61	130.90	150.54	153.40	176.41	165.60	190.44
23	122.90	141.34	142.10	163.42	166.80	191.82	179.90	206.89
24	133.10	153.07	153.40	176.41	180.90	208.04	195.10	224.37
25+	EMAIL FOR QUOTE							

LETTER HEIGHT - MAX DIMENSION

### Pricing Notes:

- Price includes either plain, stud or double face tape mount and installation pattern / stencil
- Stud mount on 1/4" & up material will be flush (drilled and tapped)
- Lower case is 75% of the corresponding Upper Case price
- Small punctuation, such as a comma, period and dash are 33% of the Upper Case price
- To see pricing for additional finishes and mounting options see the Comprehensive Product & Pricing Guide



## Metal Laminate on Acrylic Letters

**PRICE PER LETTER - Includes standard mounting and pattern**

SIZE	3/4" THICK PAINTED EDGE	1" THICK PAINTED EDGE	1-1/2" THICK PAINTED EDGE
3"	\$21.80	\$29.80	\$53.90
4	25.60	35.30	63.60
5	27.90	38.40	69.20
6	32.40	45.00	80.90
7	37.70	52.20	93.90
8	44.50	61.20	110.20
9	50.30	69.60	124.90
10	57.40	79.10	142.40
11	64.10	88.40	159.10
12	73.50	101.20	182.30
13	83.10	114.70	206.40
14	92.90	128.20	230.80
15	98.00	135.30	243.50
16	107.30	148.10	266.60
17	117.30	161.90	291.30
18	129.10	177.30	319.40
19	140.30	193.60	348.50
20	154.10	212.60	382.80
21	168.00	231.90	417.30
22	183.20	252.80	454.90
23	198.40	274.00	493.10
24	214.40	295.90	532.50
25+	EMAIL FOR QUOTE		

LETTER HEIGHT - MAX DIMENSION

**Pricing Notes:**

- Price includes either plain, stud or double face tape mount and installation pattern / stencil
- Stud mount on 1/4" & up material will be flush (drilled and tapped)
- Lower case is 75% of the corresponding Upper Case price
- Small punctuation, such as a comma, period and dash are 33% of the Upper Case price
- To see pricing for additional finishes and mounting options see the Comprehensive Product & Pricing Guide

# 1/8" or 3/16" Thick - Metal Laminate with Black or Platinum Edge Logo

## PRICE PER LOGO - Includes standard mounting and pattern

SIZE	10"	11"	12"	13"	14"	15"	16"	17"	18"	19"	20"	21"	22"	23"	24"
10"	\$46.50	\$50.60	\$53.40	\$56.30	\$59.10	\$60.90	\$63.70	\$67.70	\$70.60	\$78.30	\$84.70	\$90.00	\$94.00	\$100.40	\$105.70
11	50.60	55.10	58.30	61.70	64.90	66.90	70.30	73.50	78.10	86.00	92.90	98.60	102.90	109.80	115.40
12	53.40	58.30	63.30	66.90	70.60	73.00	75.50	79.20	85.30	93.80	100.90	107.00	111.90	119.10	125.20
13	56.30	61.70	66.90	72.20	76.20	79.10	82.10	84.90	92.60	101.30	109.00	115.50	120.80	128.50	134.90
14	59.10	64.90	70.60	76.20	82.00	85.20	88.50	91.80	99.80	109.10	117.20	124.00	129.80	137.80	144.70
15	60.90	66.90	73.00	79.10	85.20	91.20	94.90	98.70	107.10	116.80	125.20	132.50	138.60	147.10	154.30
16	63.70	70.30	75.50	82.10	88.50	94.90	101.60	105.60	114.50	124.50	133.30	141.10	147.50	156.50	164.20
17	67.70	73.50	79.20	84.90	91.80	98.70	105.60	112.50	121.70	132.30	141.50	149.60	156.50	165.80	173.90
18	70.60	78.10	85.30	92.60	99.80	107.10	114.50	121.70	129.10	139.80	149.60	158.20	165.40	175.00	183.50
19	78.30	86.00	93.80	101.30	109.10	116.80	124.50	132.30	139.80	147.60	157.60	166.60	174.40	184.30	193.30
20	84.70	92.90	100.90	109.00	117.20	125.20	133.30	141.50	149.60	157.60	165.80	175.00	183.20	193.60	203.00
21	90.00	98.60	107.00	115.50	124.00	132.50	141.10	149.60	158.20	166.60	175.00	183.60	192.10	203.10	212.80
22	94.00	102.90	111.90	120.80	129.80	138.60	147.50	156.50	165.40	174.40	183.20	192.10	201.10	212.40	222.50
23	100.40	109.80	119.10	128.50	137.80	147.10	156.50	165.80	175.00	184.30	193.60	203.10	212.40	221.70	242.00
24	105.70	115.40	125.20	134.90	144.70	154.30	164.20	173.90	183.50	193.30	203.00	212.80	222.50	232.10	242.00
25"+	EMAIL FOR QUOTE														

**LOGOS SMALLER THAN 10" X 10" CAN BE PRICED AS A LETTER USING THE MAXIMUM DIMENSION**  
**LOGOS LARGER THAN SIZES SHOWN OR CONTAINING 31+ PIECES/CUTOUPS**  
**EMAIL: [Signage@GeminiMade.com](mailto:Signage@GeminiMade.com)**

# 1/8" or 3/16" Thick - Metal Laminate with Other Colored Edge Logo

## PRICE PER LOGO - Includes standard mounting and pattern

SIZE	10"	11"	12"	13"	14"	15"	16"	17"	18"	19"	20"	21"	22"	23"	24"
10"	\$53.48	\$58.19	\$61.41	\$64.75	\$67.97	\$70.04	\$73.26	\$77.86	\$81.19	\$90.05	\$97.41	\$103.50	\$108.10	\$115.46	\$121.56
11	58.19	63.37	67.05	70.96	74.64	76.94	80.85	84.53	89.82	98.90	106.84	113.39	118.34	126.27	132.71
12	61.41	67.05	72.80	76.94	81.19	83.95	86.83	91.08	98.10	107.87	116.04	123.05	128.69	136.97	143.98
13	64.75	70.96	76.94	83.03	87.63	90.97	94.42	97.64	106.49	116.50	125.35	132.83	138.92	147.78	155.14
14	67.97	74.64	81.19	87.63	94.30	97.98	101.78	105.57	114.77	125.47	134.78	142.60	149.27	158.47	166.41
15	70.04	76.94	83.95	90.97	97.98	104.88	109.14	113.51	123.17	134.32	143.98	152.38	159.39	169.17	177.45
16	73.26	80.85	86.83	94.42	101.78	109.14	116.84	121.44	131.68	143.18	153.30	162.27	169.63	179.98	188.83
17	77.86	84.53	91.08	97.64	105.57	113.51	121.44	129.38	139.96	152.15	162.73	172.04	179.98	190.67	199.99
18	81.19	89.82	98.10	106.49	114.77	123.17	131.68	139.96	148.47	160.77	172.04	181.93	190.21	201.25	211.03
19	90.05	98.90	107.87	116.50	125.47	134.32	143.18	152.15	160.77	169.74	181.24	191.59	200.56	211.95	222.30
20	97.41	106.84	116.04	125.35	134.78	143.98	153.30	162.73	172.04	181.24	190.67	201.25	210.68	222.64	233.45
21	103.50	113.39	123.05	132.83	142.60	152.38	162.27	172.04	181.93	191.59	201.25	211.14	220.92	233.57	244.72
22	108.10	118.34	128.69	138.92	149.27	159.39	169.63	179.98	190.21	200.56	210.68	220.92	231.27	244.26	255.88
23	115.46	126.27	136.97	147.78	158.47	169.17	179.98	190.67	201.25	211.95	222.64	233.57	244.26	254.96	278.30
24	121.56	132.71	143.98	155.14	166.41	177.45	188.83	199.99	211.03	222.30	233.45	244.72	255.88	266.92	278.30
25"+	EMAIL FOR QUOTE														

## 1/4" Thick - Metal Laminate with Black or Platinum Edge Logo

### PRICE PER LOGO - Includes standard mounting and pattern

SIZE	10"	11"	12"	13"	14"	15"	16"	17"	18"	19"	20"	21"	22"	23"	24"
10"	\$55.10	\$60.10	\$63.60	\$67.20	\$69.60	\$72.00	\$75.70	\$79.20	\$82.80	\$88.70	\$100.60	\$106.70	\$112.70	\$118.60	\$123.50
11	60.10	65.20	69.40	73.40	76.30	80.40	84.50	87.30	91.40	97.90	110.30	116.80	123.20	129.80	135.00
12	63.60	69.40	75.10	79.70	84.30	87.60	90.90	94.30	100.10	107.00	119.90	126.90	133.80	140.80	146.50
13	67.20	73.40	79.70	85.90	90.90	93.50	97.40	102.50	108.70	116.00	129.50	136.90	144.30	151.70	158.00
14	69.60	76.30	84.30	90.90	97.60	100.80	103.90	108.20	117.40	125.20	139.00	147.00	154.90	162.80	169.40
15	72.00	80.40	87.60	93.50	100.80	108.00	111.50	116.50	126.00	134.30	148.60	157.00	165.40	173.80	181.00
16	75.70	84.50	90.90	97.40	103.90	111.50	119.20	124.50	134.60	143.50	158.30	167.10	176.10	184.80	192.50
17	79.20	87.30	94.30	102.50	108.20	116.50	124.50	132.60	143.30	152.60	167.80	177.20	186.50	195.80	204.00
18	82.80	91.40	100.10	108.70	117.40	126.00	134.60	143.30	151.80	161.60	177.40	187.20	197.00	206.90	215.50
19	88.70	97.90	107.00	116.00	125.20	134.30	143.50	152.60	161.60	170.80	187.00	197.30	207.60	217.90	227.10
20	100.60	110.30	119.90	129.50	139.00	148.60	158.30	167.80	177.40	187.00	196.50	207.40	218.10	228.90	238.40
21	106.70	116.80	126.90	136.90	147.00	157.00	167.10	177.20	187.20	197.30	207.40	217.30	228.70	239.90	250.00
22	112.70	123.20	133.80	144.30	154.90	165.40	176.10	186.50	197.00	207.60	218.10	228.70	239.20	251.00	261.50
23	118.60	129.80	140.80	151.70	162.80	173.80	184.80	195.80	206.90	217.90	228.90	239.90	251.00	261.90	273.00
24	123.50	135.00	146.50	158.00	169.40	181.00	192.50	204.00	215.50	227.10	238.40	250.00	261.50	273.00	284.50
25"+	EMAIL FOR QUOTE														

**LOGOS SMALLER THAN 10" X 10" CAN BE PRICED AS A LETTER USING THE MAXIMUM DIMENSION**  
**LOGOS LARGER THAN SIZES SHOWN OR CONTAINING 31+ PIECES/CUTOUPS**  
**EMAIL: [Signage@GeminiMade.com](mailto:Signage@GeminiMade.com)**

## 1/4" Thick - Metal Laminate with Other Colored Edge Logo

### PRICE PER LOGO - Includes standard mounting and pattern

SIZE	10"	11"	12"	13"	14"	15"	16"	17"	18"	19"	20"	21"	22"	23"	24"
10"	\$63.37	\$69.12	\$73.14	\$77.28	\$80.04	\$82.80	\$87.06	\$91.08	\$95.22	\$102.01	\$115.69	\$122.71	\$129.61	\$136.39	\$142.03
11	69.12	74.98	79.81	84.41	87.75	92.46	97.18	100.40	105.11	112.59	126.85	134.32	141.68	149.27	155.25
12	73.14	79.81	86.37	91.66	96.95	100.74	104.54	108.45	115.12	123.05	137.89	145.94	153.87	161.92	168.48
13	77.28	84.41	91.66	98.79	104.54	107.53	112.01	117.88	125.01	133.40	148.93	157.44	165.95	174.46	181.70
14	80.04	87.75	96.95	104.54	112.24	115.92	119.49	124.43	135.01	143.98	159.85	169.05	178.14	187.22	194.81
15	82.80	92.46	100.74	107.53	115.92	124.20	128.23	133.98	144.90	154.45	170.89	180.55	190.21	199.87	208.15
16	87.06	97.18	104.54	112.01	119.49	128.23	137.08	143.18	154.79	165.03	182.05	192.17	202.52	212.52	221.38
17	91.08	100.40	108.45	117.88	124.43	133.98	143.18	152.49	164.80	175.49	192.97	203.78	214.48	225.17	234.60
18	95.22	105.11	115.12	125.01	135.01	144.90	154.79	164.80	174.57	185.84	204.01	215.28	226.55	237.94	247.83
19	102.01	112.59	123.05	133.40	143.98	154.45	165.03	175.49	185.84	196.42	215.05	226.90	238.74	250.59	261.17
20	115.69	126.85	137.89	148.93	159.85	170.89	182.05	192.97	204.01	215.05	225.98	238.51	250.82	263.24	274.16
21	122.71	134.32	145.94	157.44	169.05	180.55	192.17	203.78	215.28	226.90	238.51	249.90	263.01	275.89	287.50
22	129.61	141.68	153.87	165.95	178.14	190.21	202.52	214.48	226.55	238.74	250.82	263.01	275.08	288.65	300.73
23	136.39	149.27	161.92	174.46	187.22	199.87	212.52	225.17	237.94	250.59	263.24	275.89	288.65	301.19	313.95
24	142.03	155.25	168.48	181.70	194.81	208.15	221.38	234.60	247.83	261.17	274.16	287.50	300.73	313.95	327.18
25"+	EMAIL FOR QUOTE														



## 3/8" Thick - Metal Laminate with Black or Platinum Edge Logo

### PRICE PER LOGO - Includes standard mounting and pattern

SIZE	10"	11"	12"	13"	14"	15"	16"	17"	18"	19"	20"	21"	22"	23"	24"
10"	\$63.20	\$68.90	\$73.10	\$77.50	\$82.00	\$85.10	\$88.30	\$91.50	\$97.10	\$103.90	\$116.70	\$123.50	\$130.20	\$137.00	\$142.60
11	68.90	75.00	79.90	84.80	89.80	93.50	97.20	100.90	107.10	114.50	127.80	135.10	142.50	149.80	156.00
12	73.10	79.90	86.70	92.00	97.60	101.90	105.00	109.20	117.30	124.90	139.00	147.00	154.80	162.80	169.40
13	77.50	84.80	92.00	99.40	105.50	109.00	112.70	117.60	127.20	135.70	150.20	158.60	167.20	175.60	182.80
14	82.00	89.80	97.60	105.50	113.10	117.50	121.60	127.10	137.30	146.40	161.40	170.50	179.50	188.60	196.20
15	85.10	93.50	101.90	109.00	117.50	125.70	130.60	136.50	147.30	156.90	172.40	182.10	191.80	201.30	209.70
16	88.30	97.20	105.00	112.70	121.60	130.60	139.50	146.00	157.40	167.60	183.60	194.00	204.00	214.10	223.10
17	91.50	100.90	109.20	117.60	127.10	136.50	146.00	155.60	167.50	178.10	194.90	205.50	216.30	227.10	236.60
18	97.10	107.10	117.30	127.20	137.30	147.30	157.40	167.50	177.60	188.80	206.10	217.20	228.60	239.80	249.90
19	103.90	114.50	124.90	135.70	146.40	156.90	167.60	178.10	188.80	199.50	217.20	229.00	240.80	252.60	263.30
20	116.70	127.80	139.00	150.20	161.40	172.40	183.60	194.90	206.10	217.20	228.30	240.70	253.10	265.60	276.70
21	123.50	135.10	147.00	158.60	170.50	182.10	194.00	205.50	217.20	229.00	240.70	252.50	265.50	278.40	290.10
22	130.20	142.50	154.80	167.20	179.50	191.80	204.00	216.30	228.60	240.80	253.10	265.50	277.70	291.20	303.40
23	137.00	149.80	162.80	175.60	188.60	201.30	214.10	227.10	239.80	252.60	265.60	278.40	291.20	304.00	317.00
24	142.60	156.00	169.40	182.80	196.20	209.70	223.10	236.60	249.90	263.30	276.70	290.10	303.40	317.00	330.20
25"+	EMAIL FOR QUOTE														

**LOGOS SMALLER THAN 10" X 10" CAN BE PRICED AS A LETTER USING THE MAXIMUM DIMENSION**  
**LOGOS LARGER THAN SIZES SHOWN OR CONTAINING 31+ PIECES/CUTOUTS**  
**EMAIL: [Signage@GeminiMade.com](mailto:Signage@GeminiMade.com)**

## 3/8" Thick - Metal Laminate with Other Colored Edge Logo

### PRICE PER LOGO - Includes standard mounting and pattern

SIZE	10"	11"	12"	13"	14"	15"	16"	17"	18"	19"	20"	21"	22"	23"	24"
10"	\$72.68	\$79.24	\$84.07	\$89.13	\$94.30	\$97.87	\$101.55	\$105.23	\$111.67	\$119.49	\$134.21	\$142.03	\$149.73	\$157.55	\$163.99
11	79.24	86.25	91.89	97.52	103.27	107.53	111.78	116.04	123.17	131.68	146.97	155.37	163.88	172.27	179.40
12	84.07	91.89	99.71	105.80	112.24	117.19	120.75	125.58	134.90	143.64	159.85	169.05	178.02	187.22	194.81
13	89.13	97.52	105.80	114.31	121.33	125.35	129.61	135.24	146.28	156.06	172.73	182.39	192.28	201.94	210.22
14	94.30	103.27	112.24	121.33	130.07	135.13	139.84	146.17	157.90	168.36	185.61	196.08	206.43	216.89	225.63
15	97.87	107.53	117.19	125.35	135.13	144.56	150.19	156.98	169.40	180.44	198.26	209.42	220.57	231.50	241.16
16	101.55	111.78	120.75	129.61	139.84	150.19	160.43	167.90	181.01	192.74	211.14	223.10	234.60	246.22	256.57
17	105.23	116.04	125.58	135.24	146.17	156.98	167.90	178.94	192.63	204.82	224.14	236.33	248.75	261.17	272.09
18	111.67	123.17	134.90	146.28	157.90	169.40	181.01	192.63	204.24	217.12	237.02	249.78	262.89	275.77	287.39
19	119.49	131.68	143.64	156.06	168.36	180.44	192.74	204.82	217.12	229.43	249.78	263.35	276.92	290.49	302.80
20	134.21	146.97	159.85	172.73	185.61	198.26	211.14	224.14	237.02	249.78	262.55	276.81	291.07	305.44	318.21
21	142.03	155.37	169.05	182.39	196.08	209.42	223.10	236.33	249.78	263.35	276.81	290.38	305.33	320.16	333.62
22	149.73	163.88	178.02	192.28	206.43	220.57	234.60	248.75	262.89	276.92	291.07	305.33	319.36	334.88	348.91
23	157.55	172.27	187.22	201.94	216.89	231.50	246.22	261.17	275.77	290.49	305.44	320.16	334.88	349.60	364.55
24	163.99	179.40	194.81	210.22	225.63	241.16	256.57	272.09	287.39	302.80	318.21	333.62	348.91	364.55	379.73
25"+	EMAIL FOR QUOTE														

## 1/2" Thick - Metal Laminate with Black or Platinum Edge Logo

### PRICE PER LOGO - Includes standard mounting and pattern

SIZE	10"	11"	12"	13"	14"	15"	16"	17"	18"	19"	20"	21"	22"	23"	24"
10"	\$82.90	\$89.10	\$96.60	\$101.70	\$106.70	\$111.60	\$116.80	\$121.70	\$131.70	\$142.70	\$152.60	\$162.30	\$171.00	\$179.70	\$188.50
11	89.10	97.30	105.60	111.30	117.20	122.90	128.70	134.50	145.00	156.80	167.50	178.00	187.40	196.70	206.20
12	96.60	105.60	114.50	121.00	127.60	134.00	140.70	147.10	158.40	171.00	182.40	193.60	203.80	213.90	224.10
13	101.70	111.30	121.00	130.70	137.90	145.20	152.60	159.70	171.80	185.10	197.20	209.30	220.10	231.00	242.00
14	106.70	117.20	127.60	137.90	148.30	156.40	164.50	172.30	185.20	199.20	212.20	224.90	236.60	248.20	259.90
15	111.60	122.90	134.00	145.20	156.40	167.60	176.40	185.00	198.50	213.40	227.00	240.50	252.90	265.30	277.60
16	116.80	128.70	140.70	152.60	164.50	176.40	188.30	197.60	212.10	227.50	241.90	256.10	269.30	282.30	295.60
17	121.70	134.50	147.10	159.70	172.30	185.00	197.60	210.30	225.50	241.80	256.80	271.90	285.70	299.50	313.40
18	131.70	145.00	158.40	171.80	185.20	198.50	212.10	225.50	238.90	255.70	271.70	287.50	302.10	316.60	331.30
19	142.70	156.80	171.00	185.10	199.20	213.40	227.50	241.80	255.70	269.80	286.60	303.00	318.30	333.70	349.20
20	152.60	167.50	182.40	197.20	212.20	227.00	241.90	256.80	271.70	286.60	301.40	318.60	334.80	350.80	366.90
21	162.30	178.00	193.60	209.30	224.90	240.50	256.10	271.90	287.50	303.00	318.60	334.40	351.10	368.00	384.80
22	171.00	187.40	203.80	220.10	236.60	252.90	269.30	285.70	302.10	318.30	334.80	351.10	367.60	385.20	402.70
23	179.70	196.70	213.90	231.00	248.20	265.30	282.30	299.50	316.60	333.70	350.80	368.00	385.20	402.10	420.60
24	188.50	206.20	224.10	242.00	259.90	277.60	295.60	313.40	331.30	349.20	366.90	384.80	402.70	420.60	438.30
25"+	EMAIL FOR QUOTE														

**LOGOS SMALLER THAN 10" X 10" CAN BE PRICED AS A LETTER USING THE MAXIMUM DIMENSION**  
**LOGOS LARGER THAN SIZES SHOWN OR CONTAINING 31+ PIECES/CUTOUPS**  
**EMAIL: [Signage@GeminiMade.com](mailto:Signage@GeminiMade.com)**

## 1/2" Thick - Metal Laminate with Other Colored Edge Logo

### PRICE PER LOGO - Includes standard mounting and pattern

SIZE	10"	11"	12"	13"	14"	15"	16"	17"	18"	19"	20"	21"	22"	23"	24"
10"	\$95.34	\$102.47	\$111.09	\$116.96	\$122.71	\$128.34	\$134.32	\$139.96	\$151.46	\$164.11	\$175.49	\$186.65	\$196.65	\$206.66	\$216.78
11	102.47	111.90	121.44	128.00	134.78	141.34	148.01	154.68	166.75	180.32	192.63	204.70	215.51	226.21	237.13
12	111.09	121.44	131.68	139.15	146.74	154.10	161.81	169.17	182.16	196.65	209.76	222.64	234.37	245.99	257.72
13	116.96	128.00	139.15	150.31	158.59	166.98	175.49	183.66	197.57	212.87	226.78	240.70	253.12	265.65	278.30
14	122.71	134.78	146.74	158.59	170.55	179.86	189.18	198.15	212.98	229.08	244.03	258.64	272.09	285.43	298.89
15	128.34	141.34	154.10	166.98	179.86	192.74	202.86	212.75	228.28	245.41	261.05	276.58	290.84	305.10	319.24
16	134.32	148.01	161.81	175.49	189.18	202.86	216.55	227.24	243.92	261.63	278.19	294.52	309.70	324.65	339.94
17	139.96	154.68	169.17	183.66	198.15	212.75	227.24	241.85	259.33	278.07	295.32	312.69	328.56	344.43	360.41
18	151.46	166.75	182.16	197.57	212.98	228.28	243.92	259.33	274.74	294.06	312.46	330.63	347.42	364.09	381.00
19	164.11	180.32	196.65	212.87	229.08	245.41	261.63	278.07	294.06	310.27	329.59	348.45	366.05	383.76	401.58
20	175.49	192.63	209.76	226.78	244.03	261.05	278.19	295.32	312.46	329.59	346.61	366.39	385.02	403.42	421.94
21	186.65	204.70	222.64	240.70	258.64	276.58	294.52	312.69	330.63	348.45	366.39	384.56	403.77	423.20	442.52
22	196.65	215.51	234.37	253.12	272.09	290.84	309.70	328.56	347.42	366.05	385.02	403.77	422.74	442.98	463.11
23	206.66	226.21	245.99	265.65	285.43	305.10	324.65	344.43	364.09	383.76	403.42	423.20	442.98	462.42	483.69
24	216.78	237.13	257.72	278.30	298.89	319.24	339.94	360.41	381.00	401.58	421.94	442.52	463.11	483.69	504.05
25"+	EMAIL FOR QUOTE														

## 3/4" Thick - Metal Laminate with Painted Edge Logo

### PRICE PER LOGO - Includes standard mounting and pattern

SIZE	10"	11"	12"	13"	14"	15"	16"	17"	18"	19"	20"	21"	22"	23"	24"
10"	\$113.10	\$122.50	\$132.90	\$140.90	\$148.70	\$156.70	\$164.70	\$172.50	\$185.60	\$199.70	\$212.60	\$225.60	\$237.30	\$249.00	\$260.70
11	122.50	134.00	145.40	154.40	163.30	172.40	181.20	190.30	204.40	219.60	233.50	247.60	260.30	273.00	285.70
12	132.90	145.40	157.80	168.00	178.00	188.10	198.10	208.10	223.10	239.50	254.50	269.50	283.10	297.00	310.80
13	140.90	154.40	168.00	181.60	192.60	203.70	214.80	225.80	242.00	259.20	275.30	291.30	306.20	321.00	335.90
14	148.70	163.30	178.00	192.60	207.30	219.40	231.40	243.50	260.70	279.00	296.20	313.30	329.10	345.00	361.00
15	156.70	172.40	188.10	203.70	219.40	235.00	248.20	261.20	279.50	298.80	317.10	335.30	352.30	369.00	386.00
16	164.70	181.20	198.10	214.80	231.40	248.20	264.90	279.00	298.30	318.70	337.90	357.20	375.10	393.10	410.90
17	172.50	190.30	208.10	225.80	243.50	261.20	279.00	296.90	317.20	338.50	358.80	379.10	398.10	417.00	436.10
18	185.60	204.40	223.10	242.00	260.70	279.50	298.30	317.20	335.90	358.40	379.80	401.00	421.00	441.00	461.00
19	199.70	219.60	239.50	259.20	279.00	298.80	318.70	338.50	358.40	378.20	400.60	422.90	444.00	465.20	486.30
20	212.60	233.50	254.50	275.30	296.20	317.10	337.90	358.80	379.80	400.60	421.40	444.90	467.00	489.10	511.30
21	225.60	247.60	269.50	291.30	313.30	335.30	357.20	379.10	401.00	422.90	444.90	466.70	490.00	513.20	536.20
22	237.30	260.30	283.10	306.20	329.10	352.30	375.10	398.10	421.00	444.00	467.00	490.00	513.00	537.30	561.30
23	249.00	273.00	297.00	321.00	345.00	369.00	393.10	417.00	441.00	465.20	489.10	513.20	537.30	561.10	586.30
24	260.70	285.70	310.80	335.90	361.00	386.00	410.90	436.10	461.00	486.30	511.30	536.20	561.30	586.30	611.40
25"+	EMAIL FOR QUOTE														

**LOGOS SMALLER THAN 10" X 10" CAN BE PRICED AS A LETTER USING THE MAXIMUM DIMENSION**  
**LOGOS LARGER THAN SIZES SHOWN OR CONTAINING 31+ PIECES/CUTOUTS**  
**EMAIL: [Signage@GeminiMade.com](mailto:Signage@GeminiMade.com)**

## 1" Thick - Metal Laminate with Painted Edge Logo

### PRICE PER LOGO - Includes standard mounting and pattern

SIZE	10"	11"	12"	13"	14"	15"	16"	17"	18"	19"	20"	21"	22"	23"	24"
10"	\$135.80	\$147.30	\$159.90	\$170.20	\$180.40	\$190.60	\$200.90	\$211.10	\$226.30	\$242.80	\$257.90	\$273.00	\$287.00	\$300.90	\$314.90
11	147.30	161.40	175.30	186.70	198.30	209.90	221.40	232.90	249.30	267.00	283.40	299.90	315.00	330.20	345.50
12	159.90	175.30	190.50	203.40	216.10	228.80	241.80	254.50	272.10	291.20	308.80	326.60	343.10	359.50	376.10
13	170.20	186.70	203.40	219.70	233.80	247.90	261.90	276.00	295.10	315.20	334.30	353.20	370.90	388.70	406.50
14	180.40	198.30	216.10	233.80	251.60	267.00	282.30	297.60	317.90	339.30	359.60	380.00	398.90	418.10	437.00
15	190.60	209.90	228.80	247.90	267.00	286.00	302.60	319.40	340.80	363.50	385.00	406.60	426.90	447.30	467.50
16	200.90	221.40	241.80	261.90	282.30	302.60	323.00	340.90	363.60	387.80	410.40	433.30	454.90	476.40	498.10
17	211.10	232.90	254.50	276.00	297.60	319.40	340.90	362.50	386.50	411.90	435.90	460.00	482.80	505.60	528.60
18	226.30	249.30	272.10	295.10	317.90	340.80	363.60	386.50	409.50	436.10	461.30	486.70	510.80	535.00	559.10
19	242.80	267.00	291.20	315.20	339.30	363.50	387.80	411.90	436.10	460.20	486.70	513.40	538.80	564.20	589.40
20	257.90	283.40	308.80	334.30	359.60	385.00	410.40	435.90	461.30	486.70	512.10	540.00	566.70	593.30	619.90
21	273.00	299.90	326.60	353.20	380.00	406.60	433.30	460.00	486.70	513.40	540.00	566.80	594.70	622.60	650.60
22	287.00	315.00	343.10	370.90	398.90	426.90	454.90	482.80	510.80	538.80	566.70	594.70	622.70	651.80	681.00
23	300.90	330.20	359.50	388.70	418.10	447.30	476.40	505.60	535.00	564.20	593.30	622.60	651.80	681.00	711.50
24	314.90	345.50	376.10	406.50	437.00	467.50	498.10	528.60	559.10	589.40	619.90	650.60	681.00	711.50	741.90
25"+	EMAIL FOR QUOTE														



## 1-1/2" Thick - Metal Laminate with Black or Platinum Edge Logo

### PRICE PER LOGO - Includes standard mounting and pattern

SIZE	10"	11"	12"	13"	14"	15"	16"	17"	18"	19"	20"	21"	22"	23"	24"
10"	\$218.50	\$238.20	\$259.20	\$277.70	\$296.20	\$314.70	\$333.20	\$351.70	\$375.10	\$399.80	\$423.20	\$446.70	\$469.00	\$491.10	\$513.40
11	238.20	261.20	284.40	304.90	325.60	346.20	366.80	387.30	412.90	439.70	465.30	490.70	515.00	539.30	563.80
12	259.20	284.40	309.50	332.20	355.00	377.60	400.40	423.00	450.70	479.50	507.20	534.90	561.20	587.70	614.00
13	277.70	304.90	332.20	359.50	384.20	409.10	433.90	458.60	488.40	519.40	549.20	578.90	607.30	635.90	664.30
14	296.20	325.60	355.00	384.20	413.60	440.50	467.50	494.30	526.20	559.30	591.10	622.90	653.50	684.10	714.70
15	314.70	346.20	377.60	409.10	440.50	472.00	501.00	529.90	564.00	599.10	633.10	666.90	699.60	732.40	765.00
16	333.20	366.80	400.40	433.90	467.50	501.00	534.60	565.60	601.70	638.90	674.90	711.10	745.90	780.50	815.40
17	351.70	387.30	423.00	458.60	494.30	529.90	565.60	601.40	639.40	678.80	716.90	755.10	792.00	828.90	865.80
18	375.10	412.90	450.70	488.40	526.20	564.00	601.70	639.40	677.20	718.70	758.90	799.20	838.20	877.20	916.10
19	399.80	439.70	479.50	519.40	559.30	599.10	638.90	678.80	718.70	758.50	800.80	843.10	884.30	925.30	966.40
20	423.20	465.30	507.20	549.20	591.10	633.10	674.90	716.90	758.90	800.80	842.80	887.20	930.50	973.60	1,016.80
21	446.70	490.70	534.90	578.90	622.90	666.90	711.10	755.10	799.20	843.10	887.20	931.30	976.50	1,021.80	1,067.20
22	469.00	515.00	561.20	607.30	653.50	699.60	745.90	792.00	838.20	884.30	930.50	976.50	1,022.70	1,070.20	1,117.40
23	491.10	539.30	587.70	635.90	684.10	732.40	780.50	828.90	877.20	925.30	973.60	1,021.80	1,070.20	1,118.30	1,167.70
24	513.40	563.80	614.00	664.30	714.70	765.00	815.40	865.80	916.10	966.40	1,016.80	1,067.20	1,117.40	1,167.70	1,218.20
25" +	EMAIL FOR QUOTE														

**LOGOS SMALLER THAN 10" X 10" CAN BE PRICED AS A LETTER USING THE MAXIMUM DIMENSION**  
**LOGOS LARGER THAN SIZES SHOWN OR CONTAINING 31+ PIECES/CUTOUPS**  
**EMAIL: [Signage@GeminiMade.com](mailto:Signage@GeminiMade.com)**





## **ECONOMY AND DIMENSION**

Precision cut aluminum laminated over high density foam offers the rich look your project demands with a cost-effective solution that fits your project budget.





## METAL OR ACRYLIC ON FOAM LAMINATE

Precision CNC cut  
edges

6 standard high  
density foam depths

Letters and logos  
from 4 to 46 inches

Dramatic depths up  
to 3 inch

Industry-leading  
lead times

### ULTIMATE DIMENSION WITH MINIMUM WEIGHT

Expand what's possible in interior signage while expanding room in your budget with the most dimensional and lightest weight solution in quality signage. Gemini's expert metal and ACRYLIC craftsmanship combines with the economy and dimensionality of durable, high density urethane (HDU) foam substrate to create high-quality laminated letters and logos that have the depth and appearance of heavier and more costly alternatives. We use .030 solid Chemetal sheets of aluminum that have been treated to provide your desired finish, or our own modified acrylic sheet on your choice of color.

#### WHEN ORDERING

PLEASE SPECIFY:

- Install Environment
- Size (Height)
- Finish & Substrate Color
- Vector Art or Standard Font
- Depth
- Install Method



## Acrylic Laminates:

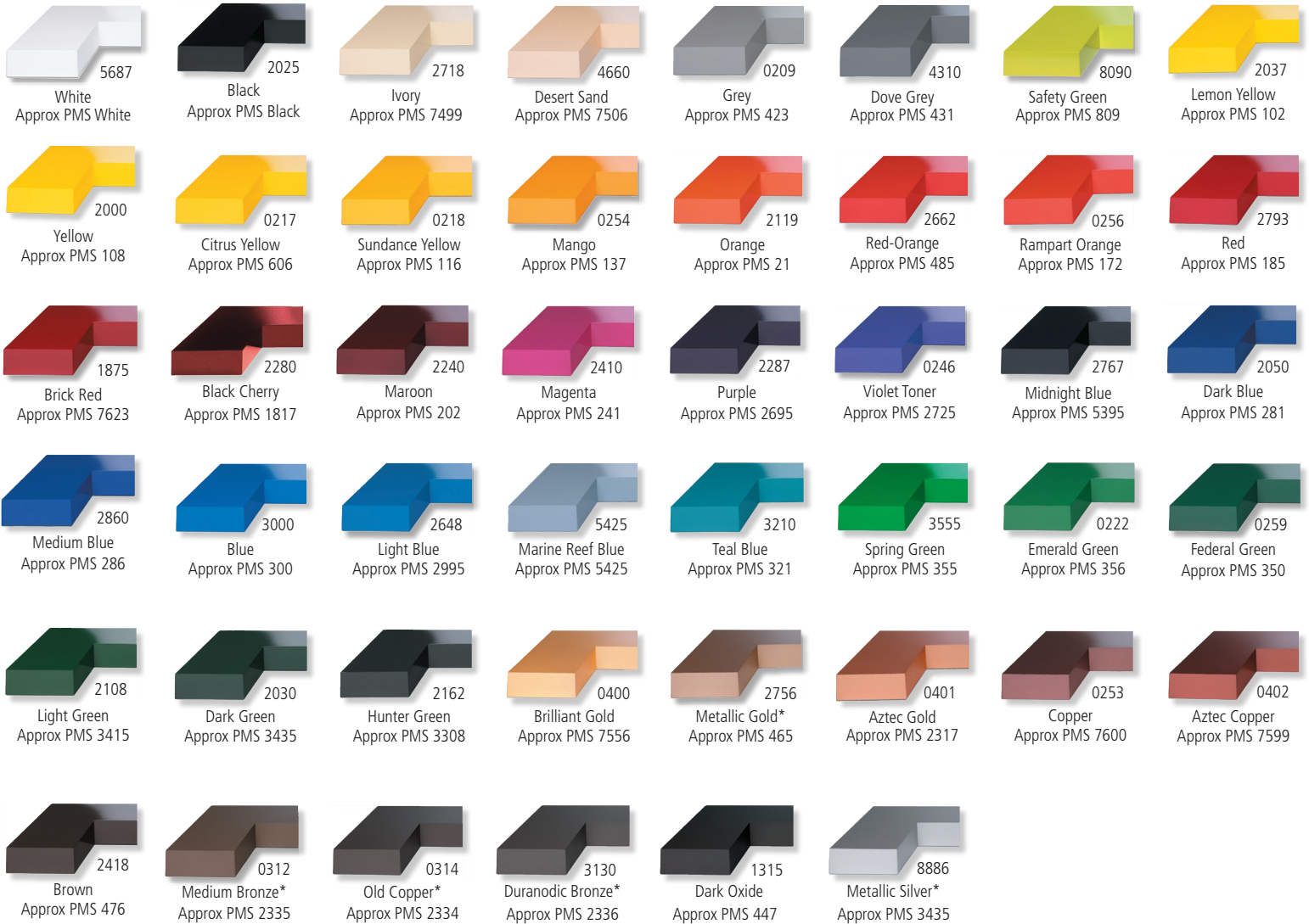

### Custom Paint Color:

It's easy to request custom color matching! Simply tell us the paint number or name and brand of paint you'd like us to match (e.g. PMS 186 or Sherwin-Williams Boathouse Blue) and we will obtain a mixing formula at no cost to you.

Don't have a paint name or number and still need a color exactly matched? Please send us a sample (sample item must be at least 3"x 3") and our paint lab will run it through an exacting color match process. Exact color matching from a sample is \$200.

### Standard Foam Edge

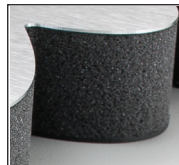

Charcoal Foam

**Standard Face Finishes:**

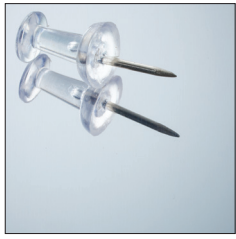

901  
Polished Aluminum



902  
Brushed Aluminum

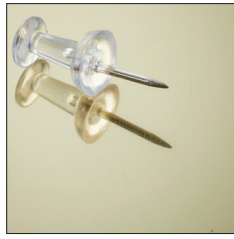

903  
Polished Brass



904  
Brushed Light Brass

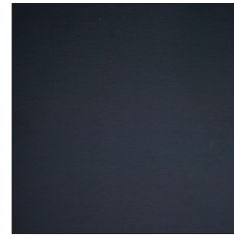

908  
Satin Black

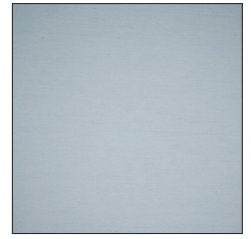

909  
Satin Silver



915  
Brushed Brass



916  
Brushed Pewter

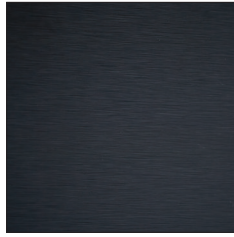

917  
Brushed Black



925  
Brushed Med. Bronze



927  
Light Stainless



906  
Brushed Copper Aluminum

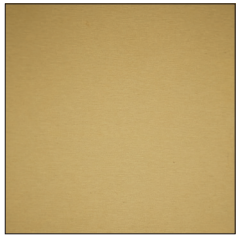

910  
Satin Gold Aluminum



924  
Bronze Stainless Aluminum



912  
Satin Bronze Aluminum



3102  
Rancho Walnut Veneer

**Special Order Finishes Also Available.**  
Email for Quote.

**CHEMETAL • treefrog • InteriorArts**  
or Your Specified Manufacturer

**Special Order CHEMETAL™ Face Finishes**  
Email for Quote

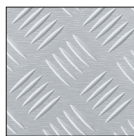

216  
Footplate



305  
Antique Brushed  
Brass Dark



310  
Antique Brass  
Brushed



314  
Mayan

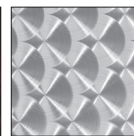

406  
Circles

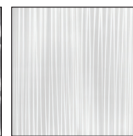

413  
Linear

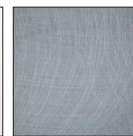

414  
Nomadic



600  
Weathered  
Aluminum

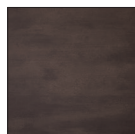

601  
Deep Bronze  
Aluminum



610  
Khaleesi  
Aluminum



613  
Ember Aluminum



614  
Beowulf Alumi-  
num

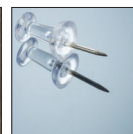

801  
Polished Chrome

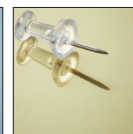

803  
Polished Solid  
Brass



804  
Satin Solid Brass



812  
Satin Smoked  
Chrome

## Mounting Options:



### Plain

Letters and logos are supplied with no mounting holes or hardware. Price as listed.



### Double Face Tape

Strips of 25mm VHB tape applied to backs of letters and logos. Maximum size varies by thickness of material. Price as listed.

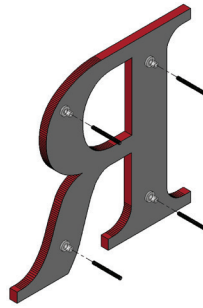

### Stud with Block

Backs of letters and logos have plastic drilled & tapped blocks glued to the back to receive threaded studs. Optional alignment for brick, block or rails. Price as listed.



### Flush Stud

Backs of letters and logos, at least 1/4" thick, are drilled and tapped to receive threaded studs, for mounting to wall. Optional alignment for brick, block or rails. Price as listed.



### Full Coverage D/F Tape

Letters and logos 4" and under can have the full coverage double face tape. Call for quote.

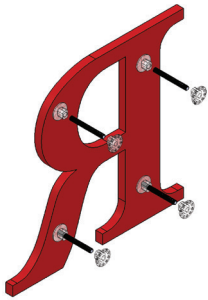

### Combination All

Same as stud mount above except adjustable pads are supplied to provide extra adhesion to mounting surface.



### Pad

Backs of letters and logos have plastic pads glued to the back. Optional alignment for rails.





# ACRYLIC Laminate on Foam Letters

## PRICE PER LETTER - Includes standard mounting and pattern

SIZE	1/2" Foam		3/4" Foam		1" Foam		1-1/2" Foam		2" Foam		3" Foam	
	CHARCOAL FOAM	PAINTED FOAM	CHARCOAL FOAM	PAINTED FOAM	CHARCOAL FOAM	PAINTED FOAM	CHARCOAL FOAM	PAINTED FOAM	CHARCOAL FOAM	PAINTED FOAM	CHARCOAL FOAM	PAINTED FOAM
4	\$18.10	\$23.53	\$20.00	\$26.00	\$22.00	\$28.60						
5	20.10	26.13	23.20	30.16	25.30	32.89	\$28.60	\$37.18	\$32.60	\$42.38		
6	24.70	32.11	28.10	36.53	30.80	40.04	33.80	43.94	36.50	47.45	\$42.60	\$55.38
7	29.80	38.74	34.00	44.20	37.50	48.75	40.60	52.78	44.00	57.20	52.20	67.86
8	36.10	46.93	41.30	53.69	45.60	59.28	49.70	64.61	53.70	69.81	63.00	81.90
9	42.60	55.38	48.30	62.79	53.00	68.90	57.60	74.88	62.70	81.51	74.10	96.33
10	50.00	65.00	56.40	73.32	62.00	80.60	67.70	88.01	73.40	95.42	86.30	112.19
11	57.20	74.36	64.60	83.98	70.90	92.17	77.30	100.49	83.70	108.81	98.70	128.31
12	66.60	86.58	75.10	97.63	82.50	107.25	89.80	116.74	97.60	126.88	115.10	149.63
13	76.50	99.45	85.80	111.54	94.40	122.72	103.00	133.90	111.60	145.08	131.40	170.82
14	87.20	113.36	97.40	126.62	107.10	139.23	116.80	151.84	126.50	164.45	149.40	194.22
15	97.80	127.14	105.80	137.54	116.60	151.58	127.20	165.36	137.80	179.14	162.90	211.77
16	108.90	141.57	118.00	153.40	129.90	168.87	141.70	184.21	153.40	199.42	180.70	234.91
17	120.90	157.17	130.60	169.78	143.70	186.81	156.80	203.84	169.70	220.61	199.80	259.74
18	133.70	173.81	144.20	187.46	158.60	206.18	172.80	224.64	187.50	243.75	221.80	288.34
19	147.40	191.62	159.10	206.83	175.30	227.89	191.20	248.56	207.10	269.23	245.10	318.63
20	162.40	211.12	175.30	227.89	193.00	250.90	210.40	273.52	227.90	296.27	268.30	348.79
21	178.00	231.40	192.20	249.86	211.30	274.69	230.50	299.65	249.50	324.35	294.30	382.59
22	194.50	252.85	210.20	273.26	231.30	300.69	252.10	327.73	273.20	355.16	322.90	419.77
23	211.50	274.95	228.30	296.79	251.10	326.43	273.70	355.81	296.60	385.58	350.30	455.39
24	229.70	298.61	247.50	321.75	272.30	353.99	297.10	386.23	321.80	418.34	379.20	492.96
25+	EMAIL FOR QUOTE											

LETTER HEIGHT - MAX DIMENSION

### Pricing Notes:

- Price includes either plain, stud or double face tape mount and installation pattern / stencil
- Lower case is 75% of the corresponding Upper Case price
- Small punctuation, such as a comma, period and dash are 33% of the Upper Case price
- To see pricing for additional finishes and mounting options see the Comprehensive Product & Pricing Guide

**Logo Pricing Available**  
**Email:**  
**Signage@GeminiMade.com**

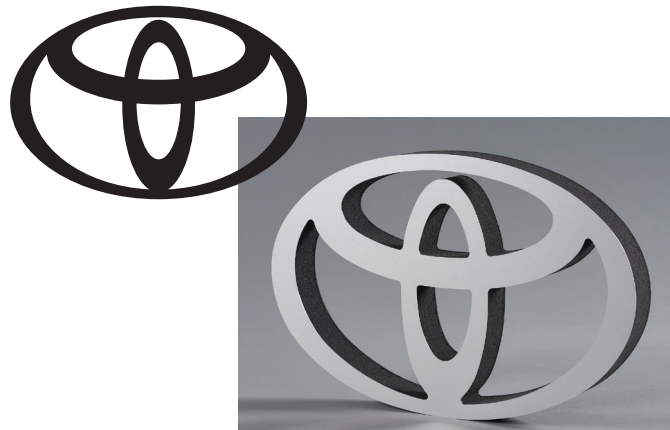

## Metal Laminate on Foam Letters

### PRICE PER LETTER - Includes standard mounting and pattern

SIZE	1/2" Foam		3/4" Foam		1" Foam		1-1/2" Foam		2" Foam		3" Foam	
	CHARCOAL FOAM	PAINTED FOAM	CHARCOAL FOAM	PAINTED FOAM	CHARCOAL FOAM	PAINTED FOAM	CHARCOAL FOAM	PAINTED FOAM	CHARCOAL FOAM	PAINTED FOAM	CHARCOAL FOAM	PAINTED FOAM
4	\$18.10	\$23.53	\$20.00	\$26.00	\$22.00	\$28.60						
5	20.10	26.13	23.20	30.16	25.30	32.89	\$28.60	\$37.18	\$32.60	\$42.38		
6	24.70	32.11	28.10	36.53	30.80	40.04	33.80	43.94	36.50	47.45	\$42.60	\$55.38
7	29.80	38.74	34.00	44.20	37.50	48.75	40.60	52.78	44.00	57.20	52.20	67.86
8	36.10	46.93	41.30	53.69	45.60	59.28	49.70	64.61	53.70	69.81	63.00	81.90
9	42.60	55.38	48.30	62.79	53.00	68.90	57.60	74.88	62.70	81.51	74.10	96.33
10	50.00	65.00	56.40	73.32	62.00	80.60	67.70	88.01	73.40	95.42	86.30	112.19
11	57.20	74.36	64.60	83.98	70.90	92.17	77.30	100.49	83.70	108.81	98.70	128.31
12	66.60	86.58	75.10	97.63	82.50	107.25	89.80	116.74	97.60	126.88	115.10	149.63
13	76.50	99.45	85.80	111.54	94.40	122.72	103.00	133.90	111.60	145.08	131.40	170.82
14	87.20	113.36	97.40	126.62	107.10	139.23	116.80	151.84	126.50	164.45	149.40	194.22
15	97.80	127.14	105.80	137.54	116.60	151.58	127.20	165.36	137.80	179.14	162.90	211.77
16	108.90	141.57	118.00	153.40	129.90	168.87	141.70	184.21	153.40	199.42	180.70	234.91
17	120.90	157.17	130.60	169.78	143.70	186.81	156.80	203.84	169.70	220.61	199.80	259.74
18	133.70	173.81	144.20	187.46	158.60	206.18	172.80	224.64	187.50	243.75	221.80	288.34
19	147.40	191.62	159.10	206.83	175.30	227.89	191.20	248.56	207.10	269.23	245.10	318.63
20	162.40	211.12	175.30	227.89	193.00	250.90	210.40	273.52	227.90	296.27	268.30	348.79
21	178.00	231.40	192.20	249.86	211.30	274.69	230.50	299.65	249.50	324.35	294.30	382.59
22	194.50	252.85	210.20	273.26	231.30	300.69	252.10	327.73	273.20	355.16	322.90	419.77
23	211.50	274.95	228.30	296.79	251.10	326.43	273.70	355.81	296.60	385.58	350.30	455.39
24	229.70	298.61	247.50	321.75	272.30	353.99	297.10	386.23	321.80	418.34	379.20	492.96
25+	EMAIL FOR QUOTE											

LETTER HEIGHT - MAX DIMENSION

**Pricing Notes:**

- Price includes either plain, stud or double face tape mount and installation pattern / stencil
- Lower case is 75% of the corresponding Upper Case price
- Small punctuation, such as a comma, period and dash are 33% of the Upper Case price
- To see pricing for additional finishes and mounting options see the Comprehensive Product & Pricing Guide

**Logo Pricing Available**  
**Email:**  
**Signage@GeminiMade.com**

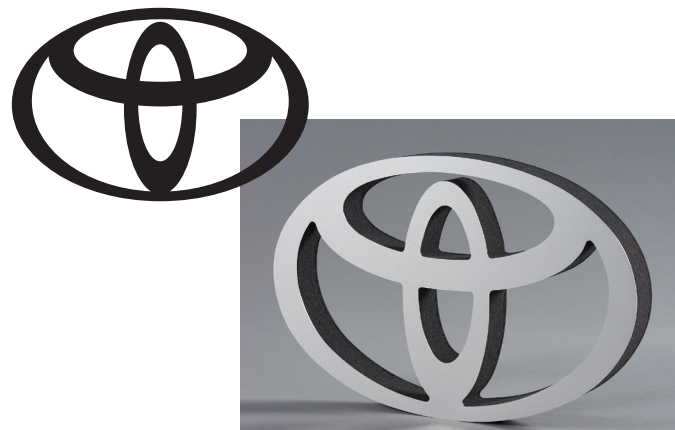



# 1/2" Thick Charcoal Foam - Metal or Plastic Laminate Face Logo

## PRICE PER LOGO - Includes standard mounting and pattern

SIZE	10"	11"	12"	13"	14"	15"	16"	17"	18"	19"	20"	21"	22"	23"	24"
10"	\$64.10	\$68.30	\$73.80	\$76.60	\$79.30	\$82.10	\$85.10	\$87.90	\$96.00	\$105.30	\$113.60	\$121.60	\$128.60	\$135.30	\$142.10
11	68.30	74.40	80.40	83.70	87.20	90.40	93.90	97.30	105.70	115.90	124.60	133.20	140.60	147.90	155.30
12	73.80	80.40	87.10	90.90	94.70	98.70	102.60	106.60	115.70	126.30	135.40	144.80	152.60	160.60	168.40
13	76.60	83.70	90.90	98.10	102.40	106.90	111.30	115.80	125.70	136.70	146.40	156.20	164.70	172.90	181.60
14	79.30	87.20	94.70	102.40	110.00	115.10	120.00	125.10	135.40	146.90	157.40	167.70	176.70	185.50	194.60
15	82.10	90.40	98.70	106.90	115.10	123.30	128.90	134.30	145.30	157.50	168.20	179.10	188.70	198.20	207.80
16	85.10	93.90	102.60	111.30	120.00	128.90	137.50	143.70	155.20	167.90	179.20	190.70	200.70	210.80	220.90
17	87.90	97.30	106.60	115.80	125.10	134.30	143.70	152.90	165.00	178.20	190.20	202.30	212.80	223.40	234.00
18	96.00	105.70	115.70	125.70	135.40	145.30	155.20	165.00	174.70	188.70	201.20	213.60	224.90	236.00	247.20
19	105.30	115.90	126.30	136.70	146.90	157.50	167.90	178.20	188.70	199.10	212.00	225.10	236.80	248.50	260.30
20	113.60	124.60	135.40	146.40	157.40	168.20	179.20	190.20	201.20	212.00	222.90	236.60	248.80	261.20	273.40
21	121.60	133.20	144.80	156.20	167.70	179.10	190.70	202.30	213.60	225.10	236.60	248.00	261.00	273.70	286.50
22	128.60	140.60	152.60	164.70	176.70	188.70	200.70	212.80	224.90	236.80	248.80	261.00	273.10	286.30	299.70
23	135.30	147.90	160.60	172.90	185.50	198.20	210.80	223.40	236.00	248.50	261.20	273.70	286.30	299.00	312.80
24	142.10	155.30	168.40	181.60	194.60	207.80	220.90	234.00	247.20	260.30	273.40	286.50	299.70	312.80	326.00
25"+	EMAIL FOR QUOTE														

**LOGOS SMALLER THAN 10" X 10" CAN BE PRICED AS A LETTER USING THE MAXIMUM DIMENSION  
LOGOS LARGER THAN SIZES SHOWN OR CONTAINING 31+ PIECES/CUTOUTS  
EMAIL: [Signage@GeminiMade.com](mailto:Signage@GeminiMade.com)**

# 1/2" Thick Painted Foam - Metal or Plastic Laminate Face Logo

## PRICE PER LOGO - Includes standard mounting and pattern

SIZE	10"	11"	12"	13"	14"	15"	16"	17"	18"	19"	20"	21"	22"	23"	24"
10"	\$83.33	\$88.79	\$95.94	\$99.58	\$103.09	\$106.73	\$110.63	\$114.27	\$124.80	\$136.89	\$147.68	\$158.08	\$167.18	\$175.89	\$184.73
11	88.79	96.72	104.52	108.81	113.36	117.52	122.07	126.49	137.41	150.67	161.98	173.16	182.78	192.27	201.89
12	95.94	104.52	113.23	118.17	123.11	128.31	133.38	138.58	150.41	164.19	176.02	188.24	198.38	208.78	218.92
13	99.58	108.81	118.17	127.53	133.12	138.97	144.69	150.54	163.41	177.71	190.32	203.06	214.11	224.77	236.08
14	103.09	113.36	123.11	133.12	143.00	149.63	156.00	162.63	176.02	190.97	204.62	218.01	229.71	241.15	252.98
15	106.73	117.52	128.31	138.97	149.63	160.29	167.57	174.59	188.89	204.75	218.66	232.83	245.31	257.66	270.14
16	110.63	122.07	133.38	144.69	156.00	167.57	178.75	186.81	201.76	218.27	232.96	247.91	260.91	274.04	287.17
17	114.27	126.49	138.58	150.54	162.63	174.59	186.81	198.77	214.50	231.66	247.26	262.99	276.64	290.42	304.20
18	124.80	137.41	150.41	163.41	176.02	188.89	201.76	214.50	227.11	245.31	261.56	277.68	292.37	306.80	321.36
19	136.89	150.67	164.19	177.71	190.97	204.75	218.27	231.66	245.31	258.83	275.60	292.63	307.84	323.05	338.39
20	147.68	161.98	176.02	190.32	204.62	218.66	232.96	247.26	261.56	275.60	289.77	307.58	323.44	339.56	355.42
21	158.08	173.16	188.24	203.06	218.01	232.83	247.91	262.99	277.68	292.63	307.58	322.40	339.30	355.81	372.45
22	167.18	182.78	198.38	214.11	229.71	245.31	260.91	276.64	292.37	307.84	323.44	339.30	355.03	372.19	389.61
23	175.89	192.27	208.78	224.77	241.15	257.66	274.04	290.42	306.80	323.05	339.56	355.81	372.19	388.70	406.64
24	184.73	201.89	218.92	236.08	252.98	270.14	287.17	304.20	321.36	338.39	355.42	372.45	389.61	406.64	423.80
25"+	EMAIL FOR QUOTE														

### 3/4" Thick Charcoal Foam - Metal or Plastic Laminate Face Logo

**PRICE PER LOGO - Includes standard mounting and pattern**

SIZE	10"	11"	12"	13"	14"	15"	16"	17"	18"	19"	20"	21"	22"	23"	24"
10"	\$66.90	\$71.50	\$77.20	\$80.20	\$83.30	\$86.50	\$89.40	\$92.60	\$101.00	\$110.80	\$119.10	\$127.50	\$134.60	\$141.70	\$148.70
11	71.50	77.70	84.00	87.80	91.40	95.00	98.80	102.40	111.40	121.50	130.60	139.70	147.10	155.00	162.70
12	77.20	84.00	91.00	95.10	99.40	103.70	107.90	112.20	121.60	132.60	142.20	151.80	160.00	168.20	176.60
13	80.20	87.80	95.10	102.60	107.60	112.50	117.20	121.70	132.10	143.40	153.60	163.90	172.60	181.40	190.20
14	83.30	91.40	99.40	107.60	115.40	120.90	126.30	131.70	142.50	154.50	165.30	176.00	185.10	194.60	204.00
15	86.50	95.00	103.70	112.50	120.90	129.60	135.60	141.60	152.80	165.50	176.70	188.00	197.80	207.80	217.70
16	89.40	98.80	107.90	117.20	126.30	135.60	144.80	151.30	163.20	176.40	188.20	199.90	210.50	221.00	231.60
17	92.60	102.40	112.20	121.70	131.70	141.60	151.30	161.10	173.40	187.20	199.70	212.00	223.10	234.50	245.40
18	101.00	111.40	121.60	132.10	142.50	152.80	163.20	173.40	183.80	198.10	211.00	224.10	235.80	247.50	259.10
19	110.80	121.50	132.60	143.40	154.50	165.50	176.40	187.20	198.10	209.20	222.60	236.20	248.40	260.90	273.10
20	119.10	130.60	142.20	153.60	165.30	176.70	188.20	199.70	211.00	222.60	234.10	248.30	261.20	273.90	286.80
21	127.50	139.70	151.80	163.90	176.00	188.00	199.90	212.00	224.10	236.20	248.30	260.40	273.80	287.30	300.60
22	134.60	147.10	160.00	172.60	185.10	197.80	210.50	223.10	235.80	248.40	261.20	273.80	286.40	300.30	314.50
23	141.70	155.00	168.20	181.40	194.60	207.80	221.00	234.50	247.50	260.90	273.90	287.30	300.30	313.70	328.20
24	148.70	162.70	176.60	190.20	204.00	217.70	231.60	245.40	259.10	273.10	286.80	300.60	314.50	328.20	342.00
25"+	EMAIL FOR QUOTE														

**LOGOS SMALLER THAN 10" X 10" CAN BE PRICED AS A LETTER USING THE MAXIMUM DIMENSION  
LOGOS LARGER THAN SIZES SHOWN OR CONTAINING 31+ PIECES/CUTOUTS  
EMAIL: [Signage@GeminiMade.com](mailto:Signage@GeminiMade.com)**

### 3/4" Thick Painted Foam - Metal or Plastic Laminate Face Logo

**PRICE PER LOGO - Includes standard mounting and pattern**

SIZE	10"	11"	12"	13"	14"	15"	16"	17"	18"	19"	20"	21"	22"	23"	24"
10"	\$86.97	\$92.95	\$100.36	\$104.26	\$108.29	\$112.45	\$116.22	\$120.38	\$131.30	\$144.04	\$154.83	\$165.75	\$174.98	\$184.21	\$193.31
11	92.95	101.01	109.20	114.14	118.82	123.50	128.44	133.12	144.82	157.95	169.78	181.61	191.23	201.50	211.51
12	100.36	109.20	118.30	123.63	129.22	134.81	140.27	145.86	158.08	172.38	184.86	197.34	208.00	218.66	229.58
13	104.26	114.14	123.63	133.38	139.88	146.25	152.36	158.21	171.73	186.42	199.68	213.07	224.38	235.82	247.26
14	108.29	118.82	129.22	139.88	150.02	157.17	164.19	171.21	185.25	200.85	214.89	228.80	240.63	252.98	265.20
15	112.45	123.50	134.81	146.25	157.17	168.48	176.28	184.08	198.64	215.15	229.71	244.40	257.14	270.14	283.01
16	116.22	128.44	140.27	152.36	164.19	176.28	188.24	196.69	212.16	229.32	244.66	259.87	273.65	287.30	301.08
17	120.38	133.12	145.86	158.21	171.21	184.08	196.69	209.43	225.42	243.36	259.61	275.60	290.03	304.85	319.02
18	131.30	144.82	158.08	171.73	185.25	198.64	212.16	225.42	238.94	257.53	274.30	291.33	306.54	321.75	336.83
19	144.04	157.95	172.38	186.42	200.85	215.15	229.32	243.36	257.53	271.96	289.38	307.06	322.92	339.17	355.03
20	154.83	169.78	184.86	199.68	214.89	229.71	244.66	259.61	274.30	289.38	304.33	322.79	339.56	356.07	372.84
21	165.75	181.61	197.34	213.07	228.80	244.40	259.87	275.60	291.33	307.06	322.79	338.52	355.94	373.49	390.78
22	174.98	191.23	208.00	224.38	240.63	257.14	273.65	290.03	306.54	322.92	339.56	355.94	372.32	390.39	408.85
23	184.21	201.50	218.66	235.82	252.98	270.14	287.30	304.85	321.75	339.17	356.07	373.49	390.39	407.81	426.66
24	193.31	211.51	229.58	247.26	265.20	283.01	301.08	319.02	336.83	355.03	372.84	390.78	408.85	426.66	444.60
25"+	EMAIL FOR QUOTE														

# 1" Thick Charcoal Foam - Metal or Plastic Laminate Face Logo

## PRICE PER LOGO - Includes standard mounting and pattern

SIZE	10"	11"	12"	13"	14"	15"	16"	17"	18"	19"	20"	21"	22"	23"	24"
10"	\$75.10	\$80.40	\$87.00	\$90.90	\$94.60	\$98.50	\$102.50	\$106.30	\$115.70	\$126.20	\$135.30	\$144.70	\$152.50	\$160.30	\$168.20
11	\$80.40	\$87.60	\$94.70	\$99.30	\$103.90	\$108.40	\$113.10	\$117.50	\$127.40	\$138.80	\$148.40	\$158.40	\$167.00	\$175.40	\$184.00
12	\$87.00	\$94.70	\$102.60	\$107.80	\$113.10	\$118.30	\$123.60	\$128.80	\$139.40	\$151.20	\$161.60	\$172.10	\$181.40	\$190.60	\$199.70
13	\$90.90	\$99.30	\$107.80	\$116.30	\$122.20	\$128.20	\$133.90	\$139.90	\$151.10	\$163.60	\$174.70	\$185.80	\$195.60	\$205.70	\$215.60
14	\$94.60	\$103.90	\$113.10	\$122.20	\$131.40	\$137.90	\$144.60	\$151.10	\$162.80	\$176.10	\$188.00	\$199.70	\$210.20	\$220.70	\$231.30
15	\$98.50	\$108.40	\$118.30	\$128.20	\$137.90	\$147.80	\$155.00	\$162.20	\$174.50	\$188.50	\$200.90	\$213.50	\$224.70	\$235.80	\$246.90
16	\$102.50	\$113.10	\$123.60	\$133.90	\$144.60	\$155.00	\$165.50	\$173.20	\$186.50	\$200.90	\$214.10	\$227.20	\$238.90	\$250.90	\$262.60
17	\$106.30	\$117.50	\$128.80	\$139.90	\$151.10	\$162.20	\$173.20	\$184.40	\$198.20	\$213.40	\$227.20	\$241.10	\$253.60	\$266.00	\$278.40
18	\$115.70	\$127.40	\$139.40	\$151.10	\$162.80	\$174.50	\$186.50	\$198.20	\$210.10	\$225.80	\$240.40	\$254.80	\$268.00	\$281.10	\$294.30
19	\$126.20	\$138.80	\$151.20	\$163.60	\$176.10	\$188.50	\$200.90	\$213.40	\$225.80	\$238.30	\$253.60	\$268.60	\$282.50	\$296.10	\$310.00
20	\$135.30	\$148.40	\$161.60	\$174.70	\$188.00	\$200.90	\$214.10	\$227.20	\$240.40	\$253.60	\$266.70	\$282.50	\$296.80	\$311.30	\$325.70
21	\$144.70	\$158.40	\$172.10	\$185.80	\$199.70	\$213.50	\$227.20	\$241.10	\$254.80	\$268.60	\$282.50	\$296.10	\$311.30	\$326.40	\$341.40
22	\$152.50	\$167.00	\$181.40	\$195.60	\$210.20	\$224.70	\$238.90	\$253.60	\$268.00	\$282.50	\$296.80	\$311.30	\$325.60	\$341.40	\$357.30
23	\$160.30	\$175.40	\$190.60	\$205.70	\$220.70	\$235.80	\$250.90	\$266.00	\$281.10	\$296.10	\$311.30	\$326.40	\$341.40	\$356.70	\$373.00
24	\$168.20	\$184.00	\$199.70	\$215.60	\$231.30	\$246.90	\$262.60	\$278.40	\$294.30	\$310.00	\$325.70	\$341.40	\$357.30	\$373.00	\$388.80
25"+	EMAIL FOR QUOTE														

**LOGOS SMALLER THAN 10" X 10" CAN BE PRICED AS A LETTER USING THE MAXIMUM DIMENSION  
LOGOS LARGER THAN SIZES SHOWN OR CONTAINING 31+ PIECES/CUTOUTS  
EMAIL: [Signage@GeminiMade.com](mailto:Signage@GeminiMade.com)**

# 1" Thick Painted Foam - Metal or Plastic Laminate Face Logo

## PRICE PER LOGO - Includes standard mounting and pattern

SIZE	10"	11"	12"	13"	14"	15"	16"	17"	18"	19"	20"	21"	22"	23"	24"
10"	\$97.63	\$104.52	\$113.10	\$118.17	\$122.98	\$128.05	\$133.25	\$138.19	\$150.41	\$164.06	\$175.89	\$188.11	\$198.25	\$208.39	\$218.66
11	\$104.52	\$113.88	\$123.11	\$129.09	\$135.07	\$140.92	\$147.03	\$152.75	\$165.62	\$180.44	\$192.92	\$205.92	\$217.10	\$228.02	\$239.20
12	\$113.10	\$123.11	\$133.38	\$140.14	\$147.03	\$153.79	\$160.68	\$167.44	\$181.22	\$196.56	\$210.08	\$223.73	\$235.82	\$247.78	\$259.61
13	\$118.17	\$129.09	\$140.14	\$151.19	\$158.86	\$166.66	\$174.07	\$181.87	\$196.43	\$212.68	\$227.11	\$241.54	\$254.28	\$267.41	\$280.28
14	\$122.98	\$135.07	\$147.03	\$158.86	\$170.82	\$179.27	\$187.98	\$196.43	\$211.64	\$228.93	\$244.40	\$259.61	\$273.26	\$286.91	\$300.69
15	\$128.05	\$140.92	\$153.79	\$166.66	\$179.27	\$192.14	\$201.50	\$210.86	\$226.85	\$245.05	\$261.17	\$277.55	\$292.11	\$306.54	\$320.97
16	\$133.25	\$147.03	\$160.68	\$174.07	\$187.98	\$201.50	\$215.15	\$225.16	\$242.45	\$261.17	\$278.33	\$295.36	\$310.57	\$326.17	\$341.38
17	\$138.19	\$152.75	\$167.44	\$181.87	\$196.43	\$210.86	\$225.16	\$239.72	\$257.66	\$277.42	\$295.36	\$313.43	\$329.68	\$345.80	\$361.92
18	\$150.41	\$165.62	\$181.22	\$196.43	\$211.64	\$226.85	\$242.45	\$257.66	\$273.13	\$293.54	\$312.52	\$331.24	\$348.40	\$365.43	\$382.59
19	\$164.06	\$180.44	\$196.56	\$212.68	\$228.93	\$245.05	\$261.17	\$277.42	\$293.54	\$309.79	\$329.68	\$349.18	\$367.25	\$384.93	\$403.00
20	\$175.89	\$192.92	\$210.08	\$227.11	\$244.40	\$261.17	\$278.33	\$295.36	\$312.52	\$329.68	\$346.71	\$367.25	\$385.84	\$404.69	\$423.41
21	\$188.11	\$205.92	\$223.73	\$241.54	\$259.61	\$277.55	\$295.36	\$313.43	\$331.24	\$349.18	\$367.25	\$384.93	\$404.69	\$424.32	\$443.82
22	\$198.25	\$217.10	\$235.82	\$254.28	\$273.26	\$292.11	\$310.57	\$329.68	\$348.40	\$367.25	\$385.84	\$404.69	\$423.28	\$443.82	\$464.49
23	\$208.39	\$228.02	\$247.78	\$267.41	\$286.91	\$306.54	\$326.17	\$345.80	\$365.43	\$384.93	\$404.69	\$424.32	\$443.82	\$463.71	\$484.90
24	\$218.66	\$239.20	\$259.61	\$280.28	\$300.69	\$320.97	\$341.38	\$361.92	\$382.59	\$403.00	\$423.41	\$443.82	\$464.49	\$484.90	\$505.44
25"+	EMAIL FOR QUOTE														



## 1-1/2" Thick Charcoal Foam - Metal or Plastic Laminate Face Logo

### PRICE PER LOGO - Includes standard mounting and pattern

SIZE	10"	11"	12"	13"	14"	15"	16"	17"	18"	19"	20"	21"	22"	23"	24"
10"	\$77.80	\$83.30	\$90.20	\$94.40	\$98.50	\$102.90	\$106.90	\$111.10	\$120.50	\$131.40	\$140.90	\$150.50	\$158.50	\$166.80	\$174.80
11	83.30	91.00	98.40	103.40	108.20	113.10	117.90	122.80	132.80	144.60	154.70	164.80	173.70	182.40	191.30
12	90.20	98.40	106.70	112.20	117.80	123.30	128.90	134.30	145.30	157.50	168.20	179.10	188.70	198.20	207.80
13	94.40	103.40	112.20	121.00	127.30	133.60	139.90	146.00	157.60	170.60	181.90	193.50	203.80	214.00	224.10
14	98.50	108.20	117.80	127.30	136.90	143.80	150.70	157.60	169.70	183.40	195.50	208.00	218.90	229.80	240.80
15	102.90	113.10	123.30	133.60	143.80	153.90	161.60	169.20	182.20	196.40	209.30	222.30	233.70	245.40	257.00
16	106.90	117.90	128.90	139.90	150.70	161.60	172.60	180.90	194.50	209.40	222.90	236.60	248.80	261.20	273.40
17	111.10	122.80	134.30	146.00	157.60	169.20	180.90	192.70	206.70	222.40	236.60	251.00	264.00	276.90	289.90
18	120.50	132.80	145.30	157.60	169.70	182.20	194.50	206.70	219.20	235.50	250.40	265.20	279.00	292.80	306.30
19	131.40	144.60	157.50	170.60	183.40	196.40	209.40	222.40	235.50	248.40	264.00	279.70	294.00	308.50	322.70
20	140.90	154.70	168.20	181.90	195.50	209.30	222.90	236.60	250.40	264.00	277.60	294.00	309.10	323.90	338.90
21	150.50	164.80	179.10	193.50	208.00	222.30	236.60	251.00	265.20	279.70	294.00	308.60	324.10	339.70	355.30
22	158.50	173.70	188.70	203.80	218.90	233.70	248.80	264.00	279.00	294.00	309.10	324.10	339.10	355.30	371.90
23	166.80	182.40	198.20	214.00	229.80	245.40	261.20	276.90	292.80	308.50	323.90	339.70	355.30	371.30	388.40
24	174.80	191.30	207.80	224.10	240.80	257.00	273.40	289.90	306.30	322.70	338.90	355.30	371.90	388.40	404.80
25"+	EMAIL FOR QUOTE														

**LOGOS SMALLER THAN 10" X 10" CAN BE PRICED AS A LETTER USING THE MAXIMUM DIMENSION**  
**LOGOS LARGER THAN SIZES SHOWN OR CONTAINING 31+ PIECES/CUTOUTS**  
**EMAIL: [Signage@GeminiMade.com](mailto:Signage@GeminiMade.com)**

## 1-1/2" Thick Painted Foam - Metal or Plastic Laminate Face Logo

### PRICE PER LOGO - Includes standard mounting and pattern

SIZE	10"	11"	12"	13"	14"	15"	16"	17"	18"	19"	20"	21"	22"	23"	24"
10"	\$101.14	\$108.29	\$117.26	\$122.72	\$128.05	\$133.77	\$138.97	\$144.43	\$156.65	\$170.82	\$183.17	\$195.65	\$206.05	\$216.84	\$227.24
11	108.29	118.30	127.92	134.42	140.66	147.03	153.27	159.64	172.64	187.98	201.11	214.24	225.81	237.12	248.69
12	117.26	127.92	138.71	145.86	153.14	160.29	167.57	174.59	188.89	204.75	218.66	232.83	245.31	257.66	270.14
13	122.72	134.42	145.86	157.30	165.49	173.68	181.87	189.80	204.88	221.78	236.47	251.55	264.94	278.20	291.33
14	128.05	140.66	153.14	165.49	177.97	186.94	195.91	204.88	220.61	238.42	254.15	270.40	284.57	298.74	313.04
15	133.77	147.03	160.29	173.68	186.94	200.07	210.08	219.96	236.86	255.32	272.09	288.99	303.81	319.02	334.10
16	138.97	153.27	167.57	181.87	195.91	210.08	224.38	235.17	252.85	272.22	289.77	307.58	323.44	339.56	355.42
17	144.43	159.64	174.59	189.80	204.88	219.96	235.17	250.51	268.71	289.12	307.58	326.30	343.20	359.97	376.87
18	156.65	172.64	188.89	204.88	220.61	236.86	252.85	268.71	284.96	306.15	325.52	344.76	362.70	380.64	398.19
19	170.82	187.98	204.75	221.78	238.42	255.32	272.22	289.12	306.15	322.92	343.20	363.61	382.20	401.05	419.51
20	183.17	201.11	218.66	236.47	254.15	272.09	289.77	307.58	325.52	343.20	360.88	382.20	401.83	421.07	440.57
21	195.65	214.24	232.83	251.55	270.40	288.99	307.58	326.30	344.76	363.61	382.20	401.18	421.33	441.61	461.89
22	206.05	225.81	245.31	264.94	284.57	303.81	323.44	343.20	362.70	382.20	401.83	421.33	440.83	461.89	483.47
23	216.84	237.12	257.66	278.20	298.74	319.02	339.56	359.97	380.64	401.05	421.07	441.61	461.89	482.69	504.92
24	227.24	248.69	270.14	291.33	313.04	334.10	355.42	376.87	398.19	419.51	440.57	461.89	483.47	504.92	526.24
25"+	EMAIL FOR QUOTE														

## 2" Thick Charcoal Foam - Metal or Plastic Laminate Face Logo

### PRICE PER LOGO - Includes standard mounting and pattern

SIZE	10"	11"	12"	13"	14"	15"	16"	17"	18"	19"	20"	21"	22"	23"	24"
10"	\$80.70	\$86.50	\$93.60	\$98.10	\$102.50	\$106.90	\$111.40	\$115.90	\$125.70	\$136.80	\$146.40	\$156.30	\$164.80	\$173.00	\$181.70
11	86.50	94.20	102.10	107.30	112.60	117.70	122.80	128.00	138.60	150.40	160.80	171.30	180.40	189.70	198.70
12	93.60	102.10	110.60	116.60	122.50	128.30	134.20	140.10	151.30	163.90	175.00	186.20	196.10	206.00	215.80
13	98.10	107.30	116.60	125.80	132.30	139.10	145.50	152.20	164.20	177.40	189.20	201.20	211.50	222.30	232.90
14	102.50	112.60	122.50	132.30	142.30	149.70	156.90	164.30	177.00	190.80	203.50	216.10	227.30	238.50	249.90
15	106.90	117.70	128.30	139.10	149.70	160.20	168.40	176.40	189.80	204.40	217.60	231.10	243.00	255.10	267.20
16	111.40	122.80	134.20	145.50	156.90	168.40	179.80	188.50	202.70	217.80	232.00	245.90	258.60	271.50	284.20
17	115.90	128.00	140.10	152.20	164.30	176.40	188.50	200.60	215.50	231.50	246.20	261.00	274.30	287.80	301.10
18	125.70	138.60	151.30	164.20	177.00	189.80	202.70	215.50	228.20	245.10	260.40	275.80	290.00	304.20	318.30
19	136.80	150.40	163.90	177.40	190.80	204.40	217.80	231.50	245.10	258.40	274.60	290.70	305.80	320.60	335.50
20	146.40	160.80	175.00	189.20	203.50	217.60	232.00	246.20	260.40	274.60	288.90	305.90	321.40	337.00	352.40
21	156.30	171.30	186.20	201.20	216.10	231.10	245.90	261.00	275.80	290.70	305.90	320.70	337.10	353.30	369.70
22	164.80	180.40	196.10	211.50	227.30	243.00	258.60	274.30	290.00	305.80	321.40	337.10	352.60	369.80	386.70
23	173.00	189.70	206.00	222.30	238.50	255.10	271.50	287.80	304.20	320.60	337.00	353.30	369.80	386.10	403.60
24	181.70	198.70	215.80	232.90	249.90	267.20	284.20	301.10	318.30	335.50	352.40	369.70	386.70	403.60	420.80
25"+	EMAIL FOR QUOTE														

**LOGOS SMALLER THAN 10" X 10" CAN BE PRICED AS A LETTER USING THE MAXIMUM DIMENSION  
LOGOS LARGER THAN SIZES SHOWN OR CONTAINING 31+ PIECES/CUTOUTS  
EMAIL: [Signage@GeminiMade.com](mailto:Signage@GeminiMade.com)**

## 2" Thick Painted Foam - Metal or Plastic Laminate Face Logo

### PRICE PER LOGO - Includes standard mounting and pattern

SIZE	10"	11"	12"	13"	14"	15"	16"	17"	18"	19"	20"	21"	22"	23"	24"
10"	\$104.91	\$112.45	\$121.68	\$127.53	\$133.25	\$138.97	\$144.82	\$150.67	\$163.41	\$177.84	\$190.32	\$203.19	\$214.24	\$224.90	\$236.21
11	112.45	122.46	132.73	139.49	146.38	153.01	159.64	166.40	180.18	195.52	209.04	222.69	234.52	246.61	258.31
12	121.68	132.73	143.78	151.58	159.25	166.79	174.46	182.13	196.69	213.07	227.50	242.06	254.93	267.80	280.54
13	127.53	139.49	151.58	163.54	171.99	180.83	189.15	197.86	213.46	230.62	245.96	261.56	274.95	288.99	302.77
14	133.25	146.38	159.25	171.99	184.99	194.61	203.97	213.59	230.10	248.04	264.55	280.93	295.49	310.05	324.87
15	138.97	153.01	166.79	180.83	194.61	208.26	218.92	229.32	246.74	265.72	282.88	300.43	315.90	331.63	347.36
16	144.82	159.64	174.46	189.15	203.97	218.92	233.74	245.05	263.51	283.14	301.60	319.67	336.18	352.95	369.46
17	150.67	166.40	182.13	197.86	213.59	229.32	245.05	260.78	280.15	300.95	320.06	339.30	356.59	374.14	391.43
18	163.41	180.18	196.69	213.46	230.10	246.74	263.51	280.15	296.66	318.63	338.52	358.54	377.00	395.46	413.79
19	177.84	195.52	213.07	230.62	248.04	265.72	283.14	300.95	318.63	335.92	356.98	377.91	397.54	416.78	436.15
20	190.32	209.04	227.50	245.96	264.55	282.88	301.60	320.06	338.52	356.98	375.57	397.67	417.82	438.10	458.12
21	203.19	222.69	242.06	261.56	280.93	300.43	319.67	339.30	358.54	377.91	397.67	416.91	438.23	459.29	480.61
22	214.24	234.52	254.93	274.95	295.49	315.90	336.18	356.59	377.00	397.54	417.82	438.23	458.38	480.74	502.71
23	224.90	246.61	267.80	288.99	310.05	331.63	352.95	374.14	395.46	416.78	438.10	459.29	480.74	501.93	524.68
24	236.21	258.31	280.54	302.77	324.87	347.36	369.46	391.43	413.79	436.15	458.12	480.61	502.71	524.68	547.04
25"+	EMAIL FOR QUOTE														

### 3" Thick Charcoal Foam - Metal or Plastic Laminate Face Logo

**PRICE PER LOGO - Includes standard mounting and pattern**

SIZE	10"	11"	12"	13"	14"	15"	16"	17"	18"	19"	20"	21"	22"	23"	24"
10"	\$91.50	\$98.40	\$106.70	\$112.20	\$117.80	\$123.30	\$128.90	\$134.30	\$145.30	\$157.50	\$168.20	\$179.10	\$188.70	\$198.20	\$207.80
11	98.40	107.40	116.40	122.80	129.30	135.60	142.00	148.30	160.00	172.90	184.60	196.40	206.70	217.10	227.40
12	106.70	116.40	126.30	133.60	140.70	147.90	155.20	162.30	174.70	188.70	201.20	213.60	224.90	236.00	247.20
13	112.20	122.80	133.60	144.20	152.20	160.20	168.20	176.30	189.70	204.30	217.50	230.90	242.90	254.80	267.00
14	117.80	129.30	140.70	152.20	163.80	172.40	181.40	190.20	204.40	219.80	234.00	248.00	261.00	273.70	286.50
15	123.30	135.60	147.90	160.20	172.40	184.80	194.50	204.10	219.20	235.50	250.40	265.20	279.00	292.80	306.30
16	128.90	142.00	155.20	168.20	181.40	194.50	207.70	218.10	233.70	251.00	266.90	282.70	297.00	311.60	326.00
17	134.30	148.30	162.30	176.30	190.20	204.10	218.10	232.10	248.70	266.80	283.30	299.80	315.10	330.60	345.70
18	145.30	160.00	174.70	189.70	204.40	219.20	233.70	248.70	263.50	282.20	299.60	317.00	333.10	349.20	365.20
19	157.50	172.90	188.70	204.30	219.80	235.50	251.00	266.80	282.20	297.70	316.00	334.30	351.30	368.10	385.20
20	168.20	184.60	201.20	217.50	234.00	250.40	266.90	283.30	299.60	316.00	332.40	351.50	369.40	386.90	404.80
21	179.10	196.40	213.60	230.90	248.00	265.20	282.70	299.80	317.00	334.30	351.50	368.70	387.30	405.80	424.40
22	188.70	206.70	224.90	242.90	261.00	279.00	297.00	315.10	333.10	351.30	369.40	387.30	405.40	424.80	444.20
23	198.20	217.10	236.00	254.80	273.70	292.80	311.60	330.60	349.20	368.10	386.90	405.80	424.80	443.70	463.90
24	207.80	227.40	247.20	267.00	286.50	306.30	326.00	345.70	365.20	385.20	404.80	424.40	444.20	463.90	483.40
25"+	EMAIL FOR QUOTE														

**LOGOS SMALLER THAN 10" X 10" CAN BE PRICED AS A LETTER USING THE MAXIMUM DIMENSION**  
**LOGOS LARGER THAN SIZES SHOWN OR CONTAINING 31+ PIECES/CUTOUTS**  
**EMAIL: [Signage@GeminiMade.com](mailto:Signage@GeminiMade.com)**

### 3" Thick Painted Foam - Metal or Plastic Laminate Face Logo

**PRICE PER LOGO - Includes standard mounting and pattern**

SIZE	10"	11"	12"	13"	14"	15"	16"	17"	18"	19"	20"	21"	22"	23"	24"
10"	\$118.95	\$127.92	\$138.71	\$145.86	\$153.14	\$160.29	\$167.57	\$174.59	\$188.89	\$204.75	\$218.66	\$232.83	\$245.31	\$257.66	\$270.14
11	127.92	139.62	151.32	159.64	168.09	176.28	184.60	192.79	208.00	224.77	239.98	255.32	268.71	282.23	295.62
12	138.71	151.32	164.19	173.68	182.91	192.27	201.76	210.99	227.11	245.31	261.56	277.68	292.37	306.80	321.36
13	145.86	159.64	173.68	187.46	197.86	208.26	218.66	229.19	246.61	265.59	282.75	300.17	315.77	331.24	347.10
14	153.14	168.09	182.91	197.86	212.94	224.12	235.82	247.26	265.72	285.74	304.20	322.40	339.30	355.81	372.45
15	160.29	176.28	192.27	208.26	224.12	240.24	252.85	265.33	284.96	306.15	325.52	344.76	362.70	380.64	398.19
16	167.57	184.60	201.76	218.66	235.82	252.85	270.01	283.53	303.81	326.30	346.97	367.51	386.10	405.08	423.80
17	174.59	192.79	210.99	229.19	247.26	265.33	283.53	301.73	323.31	346.84	368.29	389.74	409.63	429.78	449.41
18	188.89	208.00	227.11	246.61	265.72	284.96	303.81	323.31	342.55	366.86	389.48	412.10	433.03	453.96	474.76
19	204.75	224.77	245.31	265.59	285.74	306.15	326.30	346.84	366.86	387.01	410.80	434.59	456.69	478.53	500.76
20	218.66	239.98	261.56	282.75	304.20	325.52	346.97	368.29	389.48	410.80	432.12	456.95	480.22	502.97	526.24
21	232.83	255.32	277.68	300.17	322.40	344.76	367.51	389.74	412.10	434.59	456.95	479.31	503.49	527.54	551.72
22	245.31	268.71	292.37	315.77	339.30	362.70	386.10	409.63	433.03	456.69	480.22	503.49	527.02	552.24	577.46
23	257.66	282.23	306.80	331.24	355.81	380.64	405.08	429.78	453.96	478.53	502.97	527.54	552.24	576.81	603.07
24	270.14	295.62	321.36	347.10	372.45	398.19	423.80	449.41	474.76	500.76	526.24	551.72	577.46	603.07	628.42
25"+	EMAIL FOR QUOTE														





## THE POSSIBILITIES OF PLASTIC

The colorful variety and material versatility of plastic sign media offers unlimited possibilities for designers. Gemini offers multiple plastic processes, materials and options to make your project shine.



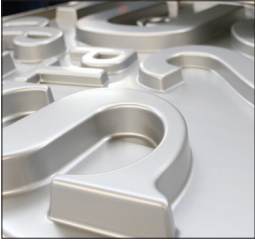

## UNLIMITED VERSATILITY FOR ANY BUDGET

High-performance plastic letters and logos deliver infinite design possibilities at an economical price.

Choose from a wide range of standard colors, plus paint colors matched to your exact requirements. Plastic sign media offers excellent durability, weather resistance, dimensional versatility, and nearly unlimited scale to satisfy any design vision.

## FLAT CUT ACRYLIC LETTERS & LOGOS



Minimum Height	Maximum Height	Maximum Size	Depth/Thickness	Application	Material
1"	95"	46" X 95"; larger sizes available as multi-piece	8 thicknesses: 1/8", 3/16", 1/4", 3/8", 1/2", 3/4", 1" & 1-1/2" based on letter height	Indoor or Outdoor Use	Acrylic

## FORMED PLASTIC LETTERS & LOGOS



Minimum Height	Maximum Height	Maximum Size	Depth/Thickness	Application	Material
4"	68"	45" X 68"; larger sizes available as multi-piece	3/4" to 2-1/2" based on letter height	Indoor or Outdoor Use	Plastic

## INJECTION MOLDED PLASTIC LETTERS



Minimum Height	Maximum Height	Maximum Size	Depth/Thickness	Application	Material
2"	18"	18" Helvetica & Times Bold; 12" Architectural	3/8" to 1-1/2" based on letter height	Indoor or Outdoor Use	Plastic





## **THE GO-TO SOLUTION**

When it comes to a superior combination of vibrant color, durability, pleasing dimension and affordability for your designs, Gemini's own engineered extrusions of high-performance acrylic and precision laser cutting technology can't be matched.





# FLAT CUT ACRYLIC

8 thicknesses and  
47 standard colors

Custom painting  
and hi-resolution  
printing options

Letters and logos  
from 1 inch to 95  
inches

Larger letters &  
logos available as  
multi-piece

Industry-leading  
lead times

## PRECISION BUILDS OF YOUR DESIGNS

Gemini's laser cut acrylic is customizable for almost any application. The quality of Gemini's acrylic sheets, available in multiple colors and created in our own state-of-the-art extrusion plant, is unsurpassed. We then utilize our advanced laser cutting capabilities and finish to your highest expectations. A number of options are available including assembly of different elements and thicknesses, standoffs, custom hand-painted detailing and color printing. For acrylic signs offering durability, maximum vibrancy and impact at a budget-friendly price, the possibilities are nearly limitless.

### WHEN ORDERING

PLEASE SPECIFY:

- Install Environment
- Size (Height)
- Color Selection
- Vector Art or Standard Font
- Thickness
- Install Method

# Acrylic Colors:

BEST VALUE IN 1/8" - 1/2" LETTERS

 2025 Black Approx PMS Black	 5687 White Approx PMS White	 8886 Metallic Silver* Approx PMS 420	 2718 Ivory Approx PMS 7499	 4660 Desert Sand Approx PMS 7506	 0209 Grey Approx PMS 423	 4310 Dove Grey Approx PMS 431	 8090 Safety Green Approx PMS 809
 2037 Lemon Yellow Approx PMS 102	 2000 Yellow Approx PMS 108	 0217 Citrus Yellow Approx PMS 606	 0218 Sundance Yellow Approx PMS 116	 0254 Mango Approx PMS 137	 2119 Orange Approx PMS 021	 2662 Red-Orange Approx PMS 485	 0256 Rampart Orange Approx PMS 172
 2793 Red Approx PMS 185	 1875 Brick Red Approx PMS 7623	 2280 Black Cherry Approx PMS 1817	 2240 Maroon Approx PMS 202	 2410 Magenta Approx PMS 241	 2287 Purple Approx PMS 2695	 0246 Violet Toner Approx PMS 2725	 2767 Midnight Blue Approx PMS 5395
 2050 Dark Blue Approx PMS 281	 2860 Medium Blue Approx PMS 286	 3000 Blue Approx PMS 300	 2648 Light Blue Approx PMS 2995	 5425 Marine Reef Blue Approx PMS 5425	 3210 Teal Blue Approx PMS 321	 3555 Spring Green Approx PMS 355	 0222 Emerald Green Approx PMS 356
 0259 Federal Green Approx PMS 350	 2108 Light Green Approx PMS 3415	 2030 Dark Green Approx PMS 3435	 2162 Hunter Green Approx PMS 3308	 0400 Brilliant Gold Approx PMS 7556	 2756 Metallic Gold* Approx PMS 465	 0401 Aztec Gold Approx PMS 2317	 0253 Copper Approx PMS 7600
 0402 Aztec Copper Approx PMS 7599	 2418 Brown Approx PMS 476	 0312 Medium Bronze* Approx PMS 2335	 0314 Old Copper* Approx PMS 2334	 3130 Duranodic Bronze* Approx PMS 2336	 1315 Dark Oxide Approx PMS 447	 2225 Optical Clear	

\* Indicates colors that do not have a full gloss finish.

## Custom Paint Color:



It's easy to request custom color matching! Simply tell us the paint number or name of the brand of paint you'd like us to match (e.g. PMS 186 or Sherwin-Williams Boathouse Blue) and we will obtain a mixing formula at no cost to you.

Don't have a paint name or number and still need a color exactly matched? Please send us a sample (sample item must be at least 3" x 3") and our paint lab will run it through an exacting color match process. Exact color matching from a sample is \$200.

**Standard Mounting Options:**



**Plain**

Letters and logos are supplied with no mounting holes or hardware. Price as listed including stencil guide.



**Double Face Tape**

Strips of 25mm VHB tape applied to backs of letters and logos. Maximum size varies by thickness of material. Price as listed including stencil guide.

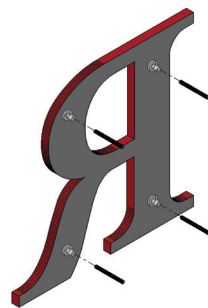

**Stud with Block**

Backs of letters and logos have plastic drilled & tapped blocks glued to the back to receive threaded studs. Optional alignment for brick, block or rails. Price as listed including drill pattern.



**Flush Stud**

Backs of letters and logos, at least 1/4" thick, are drilled and tapped to receive threaded studs, for mounting to wall. Optional alignment for brick, block or rails. Price as listed including drill pattern.

**Optional Mounting:**



**Pad-ADD 5%**

Backs of letters and logos have plastic pads glued to the back. Optional alignment for rails. Price includes stencil guide.

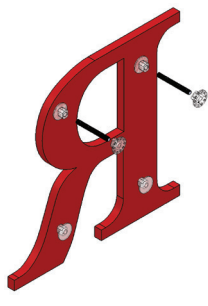

**Combination-ADD 5%**

Stud thru pad at the top of the letter and pads on the bottom part. Price includes drill pattern.

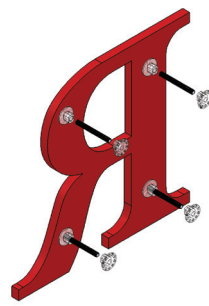

**Combination All-ADD 5%**

Same as stud mount above except adjustable pads are supplied to provide extra adhesion to mounting surface. Price includes drill pattern.



**Full Coverage D/F Tape**

Letters and logos 4" and under can have the full coverage double face tape. Call for quote.



**Inset Double Face Tape**

Call for quote



# Standard Fonts

Adrianna Bold	<b>ABCDEFGF abc 123</b>	ClearviewOne-Bold	<b>ABCDEFGF abc 123</b>
Adrianna Demibold	<b>ABCDEFGF abc 123</b>	Comic Sans Bold	<b>ABCDEFGF abc 123</b>
Adrianna Extrabold	<b>ABCDEFGF abc 123</b>	Commercial Script	<i>ABCDEFGF abc 123</i>
Americana Bold	<b>ABCDEFGF abc 123</b>	Consort	<b>ABCDEFGF abc 123</b>
Antique Olive Medium	<b>ABCDEFGF abc 123</b>	Consort Condensed	<b>ABCDEFGF abc 123</b>
Architectural	<b>ABCDEFGF abc 123</b>	Cooper Black	<b>ABCDEFGF abc 123</b>
Arial	<b>ABCDEFGF abc 123</b>	Cooper Black Italic	<b>ABCDEFGF 123</b>
Arial Bold	<b>ABCDEFGF 123</b>	Copperplate	<b>ABCDEFGF 123</b>
Avant Extra Bold	<b>ABCDEFGF abc 123</b>	Craw Clarendon Condensed	<b>ABCDEFGF abc 123</b>
Avant Garde Medium	<b>ABCDEFGF abc 123</b>	Eurostyle Bold Extended	<b>ABCDEFGF 123</b>
Barnum	<b>ABCDEFGF 123</b>	Eurostyle Bold Extended Italic	<b>ABCDEFGF 123</b>
Barnum Classic	<b>ABCDEFGF 123</b>	Fairbanks	<b>ABCDEFGF abc 123</b>
Bauhaus	<b>ABCDEFGF abc 123</b>	Forward Thinking	<b>ABCDEFGF abc 123</b>
Benguiat	<b>ABCDEFGF abc 123</b>	Friz Quadrata	<b>ABCDEFGF abc 123</b>
Bodoni Condensed	<b>ABCDEFGF 123</b>	Frutiger 65	<b>ABCDEFGF abc 123</b>
Bodoni Italic	<b>ABCDEFGF abc 123</b>	Futura	<b>ABCDEFGF abc 123</b>
Brush Script	<i>ABCDEFGF abc 123</i>	Futura Demi Bold	<b>ABCDEFGF abc 123</b>
Caslon Adbold	<b>ABCDEFGF 123</b>	Futura Bold	<b>ABCDEFGF abc 123</b>
Casual Italic Script	<i>ABCDEFGF abc 123</i>	Futura Condensed	<b>ABCDEFGF abc 123</b>
Century Schoolbook Bold	<b>ABCDEFGF 123</b>	Futura Extra Bold Italic	<b>ABCDEFGF abc 123</b>
Century Bold Condensed	<b>ABCDEFGF abc 123</b>	Garamond Book	<b>ABCDEFGF abc 123</b>
Clarendon Fortune Bold	<b>ABCDEFGF abc 123</b>	Garamond Regular	<b>ABCDEFGF abc 123</b>
Clarendon Medium	<b>ABCDEFGF 123</b>	Garamond Italic	<i>ABCDEFGF abc 123</i>
Clarion	<b>ABCDEFGF 123</b>	Garamond Bold	<b>ABCDEFGF abc 123</b>
ClearviewOne-Light	<b>ABCDEFGF abc 123</b>	Garamond Bold Italic	<b>ABCDEFGF abc 123</b>
		Gil Sans Bold	<b>ABCDEFGF abc 123</b>

Goudy Extra Bold	<b>ABCDEFGH abc 123</b>	Roffe	ABCDEFGH 123
Goudy Old Style	ABCDEFGH abc 123	Roman	<b>ABCDEFGH abc 123</b>
Helvetica	<b>ABCDEFGH abc 123</b>	Roman Classic	<b>ABCDEFGH 123</b>
Helvetica Light	ABCDEFGH 123	Roman Neo SB	<b>ABCDEFGH 123</b>
Helvetica Medium Italic	<i><b>ABCDEFGH abc 123</b></i>	Sculptured	<b>ABCDEF</b>
Helvetica Bold	<b>ABCDEFGH abc 123</b>	Shopaganda Condensed	<b>ABCDEFGH abc 123</b>
Helvetica Medium Condensed	<b>ABCDEFGH abc 123</b>	Shopaganda Regular	<b>ABCDEFGH abc 123</b>
Helvetica Bold Extended	<b>ABCDEFGH abc 123</b>	Standard Block	<b>ABCDEFGH abc 123</b>
Herman Italic	<i><b>ABCDEFGH abc 123</b></i>	Standard Block Condensed	<b>ABCDEFGH 123</b>
Hydropower Extracondensed	<b>ABCDEFGH abc 123</b>	Stettler	ABCDEFGH 123
Impact	<b>ABCDEFGH abc 123</b>	Timeless Geometric	<b>ABCDEFGH abc 123</b>
Italicized Script	<i><b>ABCDEFGH abc 123</b></i>	Times Bold	<b>ABCDEFGH abc 123</b>
Kabel	ABCDEFGH 123	Times Bold Italic	<i><b>ABCDEFGH abc 123</b></i>
Kegger	<b>ABCDEFGH abc 123</b>	Times New Roman	ABCDEFGH abc 123
Lithos Bold	<b>ABCDEFGH 123</b>	Times New Roman Italic	<i><b>ABCDEFGH abc 123</b></i>
Microgramma Extended	ABCDEFGH 123	Times Roman	ABCDEFGH abc 123
Microgramma Bold Extended	<b>ABCDEFGH 123</b>	Trajan Bold	ABCDEFGH 123
Old English	<b>ABCDEF</b> abc 123	Twentieth Century	<b>ABCDEFGH 123</b>
Optima	ABCDEFGH abc 123	Univers 67	<b>ABCDEFGH abc 123</b>
Optima Semi Bold	<b>ABCDEFGH abc 123</b>	University Roman	ABCDEFGH abc 123
Palatino	ABCDEFGH abc 123	University Roman Bold	ABCDEFGH abc 123
Palatino Bold	<b>ABCDEFGH abc 123</b>	Venus	<b>ABCDEFGH 123</b>
Palatino Semi Bold	<b>ABCDEFGH 123</b>		
Ribbon	ABCDEFGH 123		
Ribbon Condensed	ABCDEFGH 123		

## Custom UV Printing

Where multi-step painting and masking is impractical, Gemini's custom color print technology lets you faithfully reproduce your most complex designs, intricately detailed graphical elements, sophisticated color gradients or any photographic images directly onto sign materials. Our advanced, ink jet printing technology lets us print with dimensionally-stable, highly saturated color inks to reproduce virtually any image or design, and is a great option to create strong visual impact at a reasonable cost.

Our full-color inkjet printing capabilities let us print directly to flat acrylic, as well as many other substrates including aluminum, brass, bronze and stainless steel. With print resolution at 1,200 dpi, images are vivid, gradients are smooth and the color spectrum is virtually limitless. Our inks are all UV-cured and tested for UV resistance.

From one sign to many, Gemini's custom printing capabilities also let you create sign elements with 100% repeatability.

Email [Signage@GeminiMade.com](mailto:Signage@GeminiMade.com) for a quote.



# BANK GUARD



## Custom Painting

Gemini is fully equipped to paint acrylic letters and logos per your requirements. By allowing us to provide you with high quality, UV stable, polyurethane painted products, you're assured of guaranteed quality – while avoiding the extra labor, costly resources, and environmental challenges that can be associated with spraying paint – and our paint is guaranteed for life.

Email [Signage@GeminiMade.com](mailto:Signage@GeminiMade.com) for a quote.



# 1/8", 3/16", 1/4", 3/8" & 1/2" Thick Acrylic Letters

## PRICE PER LETTER - STANDARD MOUNTING & INSTALL PATTERN INCLUDED

Lower case is 75% of corresponding Upper Case price. Small punctuation, such as comma, period and dash are 33% of Upper Case price.

  = Upper Case Only

SIZE	1/8" or 3/16" THICK		1/4" THICK		3/8" THICK		1/2" THICK	
	BLACK or WHITE	OTHER STANDARD COLORS	BLACK or WHITE	OTHER STANDARD COLORS	BLACK or WHITE	OTHER STANDARD COLORS	BLACK or WHITE	OTHER STANDARD COLORS
1"	\$4.10	\$5.33	\$5.00	\$6.50	\$7.10	\$9.23	---	---
2	5.00	6.50	5.80	7.54	9.50	12.35	11.80	15.34
3	5.30	6.89	6.80	8.84	11.80	15.34	13.00	16.90
4	5.70	7.41	8.00	10.40	13.00	16.90	15.40	20.02
5	6.40	8.32	8.50	11.05	14.10	18.33	16.50	21.45
6	7.00	9.10	9.60	12.48	16.50	21.45	18.90	24.57
7	8.20	10.66	11.60	15.08	17.60	22.88	21.20	27.56
8	9.50	12.35	14.00	18.20	21.20	27.56	24.70	32.11
9	11.20	14.56	16.40	21.32	23.50	30.55	28.30	36.79
10	13.70	17.81	19.10	24.83	27.10	35.23	31.80	41.34
11	15.30	19.89	21.40	27.82	29.40	38.22	35.30	45.89
12	17.20	22.36	24.10	31.33	33.00	42.90	40.00	52.00
13	19.40	25.22	26.70	34.71	37.60	48.88	47.00	61.10
14	21.60	28.08	30.80	40.04	42.40	55.12	51.80	67.34
15	23.80	30.94	33.90	44.07	47.00	61.10	54.10	70.33
16	25.90	33.67	37.30	48.49	51.80	67.34	60.00	78.00
17	28.00	36.40	40.90	53.17	55.30	71.89	64.60	83.98
18	30.50	39.65	44.40	57.72	61.10	79.43	70.50	91.65
19	33.00	42.90	47.90	62.27	65.90	85.67	78.80	102.44
20	36.70	47.71	51.30	66.69	72.90	94.77	85.90	111.67
21	40.30	52.39	55.50	72.15	80.00	104.00	92.90	120.77
22	43.80	56.94	63.40	82.42	85.90	111.67	101.10	131.43
23	47.50	61.75	68.10	88.53	94.00	122.20	110.50	143.65
24	51.10	66.43	72.80	94.64	102.30	132.99	118.80	154.44
25			77.70	101.01	109.40	142.22	128.10	166.53
26			83.40	108.42	117.50	152.75	136.40	177.32
27			88.50	115.05	124.60	161.98	146.90	190.97
28			92.30	119.99	134.00	174.20	156.40	203.32
29			94.70	123.11	142.30	184.99	165.80	215.54
30*			100.70	130.91	151.60	197.08	177.50	230.75
31*			107.40	139.62	161.00	209.30	188.00	244.40
32*			113.90	148.07	171.60	223.08	201.00	261.30
33*			120.20	156.26	181.00	235.30	212.80	276.64
34*			126.80	164.84	191.60	249.08	223.30	290.29
35*			133.20	173.16	201.00	261.30	236.30	307.19
36*			140.10	182.13	212.80	276.64	248.00	322.40
37*			147.20	191.36	223.30	290.29	262.20	340.86
38*			154.50	200.85	235.00	305.50	275.00	357.50
39*			161.80	210.34	245.70	319.41	287.90	374.27
40*			168.90	219.57	257.40	334.62	302.00	392.60
42*			183.90	239.07	280.90	365.17	329.10	427.83
44*			200.70	260.91	304.40	395.72	357.30	464.49
46*			217.30	282.49	327.90	426.27	384.30	499.59
48*			235.00	305.50	352.60	458.38	413.70	537.81
49+	EMAIL FOR QUOTE							

LETTER HEIGHT - MAX DIMENSION

\*Oversize charges will apply

### 3/4", 1" & 1-1/2" Thick Acrylic Letters

#### PRICE PER LETTER - STANDARD MOUNTING & INSTALL PATTERN INCLUDED

SIZE	3/4" THICK ANY STANDARD COLOR	1" THICK ANY STANDARD COLOR	1-1/2" THICK ANY STANDARD COLOR
2"	\$15.40	\$22.40	\$38.90
3	17.60	24.70	44.70
4	20.00	29.40	52.90
5	23.50	31.80	56.50
6	27.10	37.60	67.00
7	30.60	43.50	77.60
8	36.50	51.80	90.50
9	41.10	57.60	103.50
10	45.90	65.90	117.50
11	52.90	72.90	131.60
12	60.00	83.50	150.50
13	68.30	95.30	170.40
14	75.30	105.80	190.40
15	80.00	111.60	201.00
16	87.00	122.30	219.80
17	95.30	132.90	240.90
18	104.60	145.80	264.40
19	114.00	159.90	287.90
20	125.80	175.20	316.20
21	137.50	190.40	344.40
22	148.10	209.30	374.90
23	161.00	226.90	407.80
24	174.00	244.50	439.60
25	186.90	262.20	472.50
26	201.00	282.00	507.70
27	215.20	300.90	541.80
28	229.20	322.10	579.50
29	244.50	342.10	615.90
30*	259.80	364.30	654.60
31*	275.00	384.30	691.10
32*	290.30	406.70	731.00
33*	304.40	427.80	778.00
34*	320.90	450.20	808.60
35*	336.20	470.10	843.90
36*	351.40	492.50	885.00
37*	370.20	520.70	923.80
38*	389.10	545.30	981.30
39*	409.10	571.20	1,029.50
40*	427.80	598.20	1,077.70
42*	465.40	652.20	1,172.90
44*	504.20	707.50	1,272.80
46*	544.20	762.80	1,372.70
48*	585.30	819.10	1,473.70
49+	EMAIL FOR QUOTE		

LETTER HEIGHT - MAX DIMENSION

**Pricing Notes:**

- Price includes either plain, stud or double face tape mount and installation pattern / stencil
- Stud mount on 1/8" material will have a 3/8"-1/2" stand-off
- Stud mount on 1/4" & up material will be flush (drilled and tapped)
- Lower case is 75% of the corresponding Upper Case price
- Small punctuation, such as a comma, period and dash are 33% of the Upper Case price
- To see pricing for additional finishes and mounting options see the Comprehensive Product & Pricing Guide

\*Oversize charges will apply



# 1/8" or 3/16" Thick Acrylic Logos

## PRICE PER LOGO - STANDARD MOUNTING & INSTALL PATTERN INCLUDED

SIZE	10"	11"	12"	13"	14"	15"	16"	17"	18"	19"	20"	21"	22"	23"	24"
10"	\$40.30	\$43.60	\$44.20	\$45.10	\$45.80	\$46.90	\$48.50	\$49.20	\$50.40	\$51.90	\$53.50	\$55.20	\$60.20	\$65.40	\$72.00
11	43.60	46.90	47.60	48.50	49.20	50.40	51.90	53.50	55.20	58.60	60.20	61.80	66.80	72.00	78.70
12	44.20	47.60	51.90	53.50	55.20	57.00	58.60	60.20	61.80	63.80	65.40	68.50	73.60	78.70	85.30
13	45.10	48.50	53.50	57.00	58.60	60.20	61.80	63.80	65.40	66.80	70.20	73.60	80.20	85.30	92.00
14	45.80	49.20	55.20	58.60	63.80	65.40	66.80	68.50	70.20	72.00	77.00	80.20	85.30	92.00	98.60
15	46.90	50.40	57.00	60.20	65.40	70.20	72.00	73.60	75.20	77.00	82.00	87.00	92.00	98.60	106.90
16	48.50	51.90	58.60	61.80	66.80	72.00	75.20	77.00	80.20	83.60	88.60	92.00	98.60	105.30	113.60
17	49.20	53.50	60.20	63.80	68.50	73.60	77.00	82.00	85.30	88.60	93.60	98.60	105.30	112.10	120.30
18	50.40	55.20	61.80	65.40	70.20	75.20	80.20	85.30	90.30	93.60	100.30	105.30	112.10	118.80	127.10
19	51.90	58.60	63.80	66.80	72.00	77.00	83.60	88.60	93.60	100.30	105.30	110.30	118.80	125.50	133.70
20	53.50	60.20	65.40	70.20	77.00	82.00	88.60	93.60	100.30	105.30	112.10	116.90	125.50	131.90	142.10
21	55.20	61.80	68.50	73.60	80.20	87.00	92.00	98.60	105.30	110.30	116.90	123.70	130.40	138.70	148.70
22	60.20	66.80	73.60	80.20	85.30	92.00	98.60	105.30	112.10	118.80	125.50	130.40	137.10	145.40	155.30
23	65.40	72.00	78.70	85.30	92.00	98.60	105.30	112.10	118.80	125.50	131.90	138.70	145.40	152.00	162.00
24	72.00	78.70	85.30	92.00	98.60	106.90	113.60	120.30	127.10	133.70	142.10	148.70	155.30	162.00	168.80
25+	EMAIL FOR QUOTE														

**LOGOS SMALLER THAN 10" X 10" CAN BE PRICED AS A LETTER USING THE MAXIMUM DIMENSION**  
**LOGOS LARGER THAN SIZES SHOWN OR CONTAINING 31+ PIECES/CUTOUTS**  
**EMAIL: [Signage@GeminiMade.com](mailto:Signage@GeminiMade.com)**

# 1/4" Thick Acrylic Logos

## PRICE PER LOGO - STANDARD MOUNTING & INSTALL PATTERN INCLUDED

SIZE	10"	12"	14"	16"	18"	20"	22"	24"	26"	28"	30"*	32"*	34"*	36"*	38"*	40"*	42"*	44"*	48"*
10"	\$52.00	\$61.10	\$64.20	\$67.30	\$70.40	\$74.90	\$84.00	\$97.80	\$113.10	\$123.80	\$131.50	\$139.10	\$151.30	\$157.50	\$168.10	\$175.70	\$183.30	\$194.10	\$209.30
11	58.20	65.80	68.70	71.80	76.40	81.10	91.70	108.60	123.80	134.60	142.20	152.80	165.10	172.80	183.30	192.60	200.20	209.30	230.80
12	61.10	70.40	76.40	81.10	84.00	90.20	100.90	117.70	132.90	145.10	154.40	166.60	178.80	186.40	198.60	206.20	218.60	229.20	249.10
13	62.70	74.90	84.00	87.10	90.20	97.80	110.00	126.90	145.10	157.50	166.60	177.30	192.60	200.20	213.90	224.60	235.30	246.10	269.00
14	64.20	76.40	88.70	91.70	94.80	106.90	117.70	136.00	154.40	168.10	178.80	191.00	204.80	217.00	230.80	239.90	249.10	264.40	288.80
15	65.80	79.50	90.20	97.80	102.40	113.10	128.40	146.80	165.10	178.80	189.50	203.30	218.60	229.20	244.40	255.20	269.00	281.20	305.60
16	67.30	81.10	91.70	104.00	111.60	122.20	136.00	154.40	175.70	191.00	201.70	215.50	233.90	244.40	259.70	272.10	284.30	297.90	325.50
17	68.70	82.60	93.30	108.60	116.20	128.40	145.10	165.10	184.90	201.70	213.90	229.20	246.10	256.80	275.00	288.80	302.60	317.90	345.40
18	70.40	84.00	94.80	111.60	123.80	136.00	152.80	175.70	195.70	212.40	226.20	239.90	259.70	273.50	290.30	302.60	317.90	334.60	363.70
19	71.80	87.10	100.90	116.20	129.90	145.10	163.50	184.90	206.20	226.20	239.90	253.70	275.00	288.80	305.60	320.80	336.10	351.40	385.00
20	74.90	90.20	106.90	122.20	136.00	151.30	172.80	194.10	218.60	236.80	250.60	267.40	287.30	301.00	320.80	336.10	351.40	369.70	401.90
21	78.00	93.30	111.60	128.40	145.10	162.00	180.40	203.30	227.70	246.10	264.40	279.70	302.60	317.90	336.10	349.90	365.20	386.60	421.70
22	84.00	100.90	117.70	136.00	152.80	172.80	188.00	213.90	236.80	258.30	275.00	290.30	313.20	330.10	351.40	366.70	385.00	403.40	441.60
23	88.70	108.60	126.90	145.10	163.50	180.40	198.60	223.10	247.50	270.40	287.30	305.60	328.50	345.40	365.20	383.60	400.30	421.70	459.90
24	97.80	117.70	136.00	154.40	175.70	194.10	213.90	232.20	256.80	279.70	297.90	317.90	342.30	359.00	381.90	398.80	417.20	440.10	479.80
26	113.10	132.90	154.40	175.70	195.70	218.60	236.80	256.80	279.70	302.60	322.40	342.30	369.70	388.10	412.50	432.50	452.30	475.20	516.50
30*	131.50	154.40	178.80	201.70	226.20	250.60	275.00	297.90	322.40	348.40	371.40	392.70	424.80	444.70	472.10	495.10	518.00	544.00	595.80
36*	157.50	186.40	217.00	244.40	273.50	301.00	330.10	359.00	388.10	418.70	444.70	470.70	505.80	533.20	565.30	591.30	617.30	650.90	708.90
40*	175.70	206.20	239.90	272.10	302.60	336.10	366.70	398.80	432.50	466.00	495.10	524.10	563.80	591.30	628.00	655.50	686.00	719.70	785.30
44*	194.10	229.20	264.40	297.90	334.60	369.70	403.40	440.10	475.20	511.80	544.00	576.00	618.70	650.90	689.10	719.70	759.30	791.50	863.20
48*	209.30	249.10	288.80	325.50	363.70	401.90	441.60	479.80	516.50	559.20	595.80	629.50	675.30	708.90	751.70	785.30	828.10	863.20	938.10

\*Oversize charges will apply

**LOGOS SMALLER THAN 10" X 10" CAN BE PRICED AS A LETTER USING THE MAXIMUM DIMENSION**  
**LOGOS LARGER THAN SIZES SHOWN OR CONTAINING 31+ PIECES/CUTOUTS**  
**EMAIL: [Signage@GeminiMade.com](mailto:Signage@GeminiMade.com)**

# 3/8" Thick Acrylic Logos

## PRICE PER LOGO - STANDARD MOUNTING & INSTALL PATTERN INCLUDED

SIZE	10"	12"	14"	16"	18"	20"	22"	24"	26"	28"	30"*	32"*	34"*	36"*	38"*	40"*	42"*	44"*	48"*
10"	\$68.70	\$81.10	\$90.20	\$94.80	\$102.40	\$108.60	\$120.80	\$137.50	\$154.40	\$169.70	\$180.40	\$192.60	\$206.20	\$217.00	\$230.80	\$241.50	\$252.10	\$265.90	\$290.30
11	76.40	87.10	99.30	105.50	111.60	120.80	132.90	151.30	171.10	186.40	198.60	210.90	226.20	238.40	252.10	264.40	276.60	290.30	317.90
12	81.10	93.30	106.90	113.10	120.80	129.90	145.10	165.10	184.90	201.70	215.50	227.70	246.10	256.80	273.50	287.30	301.00	316.30	343.70
13	87.10	102.40	113.10	122.20	128.40	139.10	158.90	180.40	198.60	215.50	230.80	246.10	265.90	278.10	296.40	308.60	323.90	340.80	371.40
14	90.20	106.90	122.20	131.50	140.60	152.80	171.10	194.10	213.90	232.20	249.10	264.40	284.30	297.90	317.90	333.20	348.40	365.20	398.80
15	91.70	110.00	126.90	139.10	149.80	163.50	183.30	206.20	227.70	249.10	265.90	281.20	304.10	319.40	339.20	354.50	371.40	389.60	426.30
16	94.80	113.10	131.50	148.20	158.90	174.20	195.70	220.10	244.40	265.90	284.30	301.00	323.90	339.20	359.00	377.40	395.70	415.60	453.80
17	99.30	116.20	136.00	152.80	171.10	184.90	207.90	232.20	258.30	281.20	299.50	319.40	343.70	360.60	381.90	400.30	418.70	440.10	481.20
18	102.40	120.80	140.60	158.90	180.40	197.10	220.10	247.50	273.50	297.90	317.90	337.70	362.10	380.50	404.90	421.70	443.10	464.50	507.20
19	105.50	123.80	146.80	165.10	186.40	207.90	232.20	261.30	287.30	311.70	334.60	354.50	380.50	400.30	426.30	444.70	466.00	490.50	533.20
20	108.60	129.90	152.80	174.20	197.10	218.60	246.10	275.00	301.00	330.10	349.90	371.40	401.90	420.10	446.10	466.00	490.50	514.90	562.30
21	114.60	136.00	160.40	183.30	206.20	229.20	258.30	288.80	317.90	345.40	368.30	389.60	420.10	440.10	467.60	490.50	514.90	539.40	589.80
22	120.80	145.10	171.10	195.70	220.10	246.10	270.40	301.00	333.20	360.60	385.00	409.60	440.10	461.40	492.00	513.40	536.30	566.90	615.80
23	129.90	154.40	181.90	207.90	232.20	261.30	285.70	316.30	346.80	377.40	403.40	426.30	458.30	482.90	513.40	534.70	560.70	589.80	644.70
24	137.50	165.10	194.10	220.10	247.50	275.00	301.00	328.50	362.10	394.30	418.70	444.70	479.80	502.70	533.20	559.20	585.20	614.20	670.70
26	154.40	184.90	213.90	244.40	273.50	301.00	333.20	362.10	389.60	424.80	453.80	481.20	518.00	544.00	577.60	603.50	632.60	664.60	725.70
30*	180.40	215.50	249.10	284.30	317.90	349.90	385.00	418.70	453.80	490.50	521.10	553.10	594.40	626.40	664.60	693.70	727.30	763.90	834.20
36*	217.00	256.80	297.90	339.20	380.50	420.10	461.40	502.70	544.00	589.80	626.40	663.10	712.00	747.10	794.40	831.20	869.40	913.70	997.70
40*	241.50	287.30	333.20	377.40	421.70	466.00	513.40	559.20	603.50	652.40	693.70	734.90	789.90	831.20	881.50	921.40	964.10	1,016.00	1,107.60
44*	265.90	316.30	365.20	415.60	464.50	514.90	566.90	614.20	664.60	718.00	763.90	809.70	872.40	913.70	970.10	1,016.00	1,071.00	1,115.30	1,214.60
48*	290.30	343.70	398.80	453.80	507.20	562.30	615.80	670.70	725.70	785.30	834.20	883.20	950.30	997.70	1,058.90	1,107.60	1,167.30	1,214.60	1,324.60

\*Oversize charges will apply

**LOGOS SMALLER THAN 10" X 10" CAN BE PRICED AS A LETTER USING THE MAXIMUM DIMENSION**  
**LOGOS LARGER THAN SIZES SHOWN OR CONTAINING 31+ PIECES/CUTOUTS**  
**EMAIL: [Signage@GeminiMade.com](mailto:Signage@GeminiMade.com)**



# 1/2" Thick Acrylic Logos

## PRICE PER LOGO - STANDARD MOUNTING & INSTALL PATTERN INCLUDED

SIZE	10"	12"	14"	16"	18"	20"	22"	24"	26"	28"	30"*	32"*	34"*	36"*	38"*	40"*	42"*	44"*	48"*
10"	\$94.80	\$108.60	\$125.30	\$132.90	\$140.60	\$152.80	\$174.20	\$195.70	\$218.60	\$236.80	\$253.70	\$269.00	\$288.80	\$302.60	\$322.40	\$337.70	\$353.00	\$371.40	\$404.90
11	104.00	117.70	134.60	143.70	154.40	171.10	189.50	215.50	236.80	261.30	276.60	293.40	316.30	331.60	353.00	369.70	386.60	406.50	444.70
12	108.60	129.90	146.80	157.50	171.10	184.90	209.30	233.90	258.30	282.60	301.00	320.80	345.40	362.10	383.60	401.90	420.10	443.10	482.90
13	116.20	137.50	157.50	171.10	183.30	203.30	226.20	253.70	281.20	305.60	325.50	345.40	372.80	389.60	415.60	433.90	455.40	476.70	521.10
14	125.30	146.80	168.10	183.30	198.60	218.60	244.40	273.50	301.00	327.00	348.40	369.70	397.20	418.70	446.10	466.00	488.90	511.80	560.70
15	129.90	152.80	177.30	195.70	212.40	233.90	261.30	293.40	322.40	349.90	374.30	395.70	426.30	447.80	475.20	498.10	522.50	547.10	598.90
16	132.90	157.50	183.30	209.30	227.70	250.60	278.10	310.30	343.70	374.30	397.20	421.70	453.80	475.20	505.80	531.80	553.10	583.60	635.60
17	136.00	163.50	189.50	218.60	243.00	267.40	297.90	331.60	365.20	394.30	421.70	447.80	482.90	505.80	537.80	563.80	588.20	618.70	675.30
18	140.60	171.10	198.60	227.70	256.80	282.60	314.80	349.90	385.00	418.70	446.10	472.10	508.90	536.30	570.00	594.40	621.80	655.50	713.50
19	146.80	177.30	207.90	236.80	269.00	299.50	333.20	371.40	406.50	441.60	470.70	499.60	537.80	565.30	602.00	628.00	656.90	690.60	753.30
20	152.80	184.90	218.60	250.60	282.60	314.80	349.90	389.60	426.30	464.50	495.10	525.60	565.30	592.90	631.10	660.00	690.60	725.70	791.50
21	162.00	195.70	229.20	262.80	297.90	330.10	368.30	407.90	447.80	487.40	519.40	548.50	592.90	621.80	660.00	690.60	722.70	760.90	829.70
22	174.20	209.30	244.40	278.10	314.80	349.90	386.60	427.80	469.10	508.90	542.40	576.00	618.70	652.40	692.20	724.20	757.90	797.50	869.40
23	183.30	221.50	258.30	296.40	333.20	369.70	406.50	447.80	490.50	531.80	566.90	602.00	646.40	681.50	722.70	754.80	789.90	831.20	907.50
24	195.70	233.90	273.50	310.30	349.90	389.60	427.80	466.00	510.30	553.10	591.30	626.40	673.80	708.90	753.30	786.80	825.00	867.90	945.70
26	218.60	258.30	301.00	343.70	385.00	426.30	469.10	510.30	553.10	602.00	640.20	678.40	728.80	768.60	815.90	852.60	892.30	939.60	1,023.60
30*	253.70	301.00	348.40	397.20	446.10	495.10	542.40	591.30	640.20	692.20	736.40	780.80	840.30	883.20	938.10	980.90	1,026.70	1,081.80	1,179.50
36*	302.60	362.10	418.70	475.20	536.30	592.90	652.40	708.90	768.60	829.70	883.20	935.00	1,006.90	1,058.90	1,124.50	1,176.40	1,228.40	1,292.60	1,410.20
40*	337.70	401.90	466.00	531.80	594.40	660.00	724.20	786.80	852.60	922.80	980.90	1,040.50	1,118.30	1,176.40	1,246.70	1,304.80	1,362.80	1,434.60	1,566.00
44*	371.40	443.10	511.80	583.60	655.50	725.70	797.50	867.90	939.60	1,016.00	1,081.80	1,142.90	1,228.40	1,292.60	1,372.00	1,434.60	1,514.10	1,576.70	1,720.30
48*	404.90	482.90	560.70	635.60	713.50	791.50	869.40	945.70	1,023.60	1,106.20	1,179.50	1,246.70	1,339.90	1,410.20	1,495.70	1,566.00	1,651.60	1,720.30	1,876.20

\*Oversize charges will apply

**LOGOS SMALLER THAN 10" X 10" CAN BE PRICED AS A LETTER USING THE MAXIMUM DIMENSION**  
**LOGOS LARGER THAN SIZES SHOWN OR CONTAINING 31+ PIECES/CUTOUTS**  
**EMAIL: [Signage@GeminiMade.com](mailto:Signage@GeminiMade.com)**

# 3/4" Thick Acrylic Logos

## PRICE PER LOGO - STANDARD MOUNTING & INSTALL PATTERN INCLUDED

SIZE	10"	12"	14"	16"	18"	20"	22"	24"	26"	28"	30"*	32"*	34"*	36"*	38"*	40"*	42"*	44"*	48"*
10"	\$101.10	\$116.40	\$132.90	\$144.60	\$156.40	\$170.40	\$191.60	\$216.30	\$237.40	\$258.50	\$276.20	\$292.70	\$315.00	\$331.40	\$351.40	\$366.70	\$384.30	\$404.30	\$440.70
11	109.40	127.00	145.80	159.90	172.80	189.30	211.50	237.40	260.90	283.30	303.30	320.90	345.60	362.10	384.30	403.20	423.10	444.30	485.40
12	116.40	138.80	159.90	172.80	189.30	206.90	231.50	258.50	283.30	309.20	329.10	349.10	376.10	394.90	420.80	438.40	459.60	481.80	526.60
13	125.80	149.30	170.40	186.90	204.50	224.50	250.40	279.80	306.80	334.90	357.30	378.40	406.70	426.70	453.70	474.80	496.00	523.00	568.80
14	132.90	159.90	183.40	202.20	221.00	243.30	269.20	302.00	331.40	359.70	381.90	405.40	437.20	459.60	489.00	510.10	533.60	561.80	613.50
15	139.90	165.80	192.80	216.30	237.40	260.90	291.50	322.10	353.80	383.20	410.20	434.80	466.60	491.30	521.80	546.50	572.30	601.70	654.60
16	144.60	172.80	202.20	230.40	252.70	278.50	310.30	344.40	376.10	407.80	436.10	461.90	496.00	523.00	554.70	581.70	607.60	639.40	699.20
17	150.50	181.00	210.40	240.90	268.00	296.20	329.10	364.30	398.40	433.70	461.90	491.30	528.80	554.70	590.00	617.00	645.20	679.40	741.60
18	156.40	189.30	221.00	252.70	284.40	315.00	347.90	386.70	421.90	459.60	490.10	519.50	558.20	587.60	622.90	652.20	681.60	718.10	782.80
19	163.40	196.30	230.40	264.40	297.40	332.70	369.10	407.80	446.60	485.40	516.00	546.50	587.60	619.40	658.10	688.70	720.50	758.00	825.00
20	170.40	206.90	243.30	278.50	315.00	350.30	389.10	430.20	469.00	510.10	544.20	575.80	619.40	651.10	692.20	724.00	758.00	796.90	867.40
21	181.00	218.70	255.00	293.80	331.40	366.70	407.80	451.30	492.50	533.60	568.80	604.10	648.70	682.90	725.10	760.40	794.50	835.60	913.20
22	191.60	231.50	269.20	310.30	347.90	389.10	428.90	472.50	516.00	559.50	595.80	632.30	679.40	714.60	760.40	795.60	832.10	875.50	955.50
23	195.20	235.00	273.90	312.70	351.40	391.40	431.30	493.60	538.30	585.30	622.90	660.50	709.90	747.50	793.30	829.80	869.60	914.40	997.80
24	216.30	258.50	302.00	344.40	386.70	430.20	472.50	514.80	561.80	608.80	650.00	688.70	739.20	779.20	827.40	865.00	906.10	953.20	1,038.90
26	237.40	283.30	331.40	376.10	421.90	469.00	516.00	561.80	607.60	660.50	704.00	746.30	800.40	843.90	895.50	936.70	979.00	1,031.90	1,125.90
30*	276.20	329.10	381.90	436.10	490.10	544.20	595.80	650.00	704.00	761.60	809.80	859.10	923.80	971.90	1,030.70	1,078.90	1,128.20	1,188.20	1,297.50
36*	331.40	394.90	459.60	523.00	587.60	651.10	714.60	779.20	843.90	878.00	971.90	1,028.30	1,105.90	1,163.40	1,235.20	1,292.70	1,351.50	1,422.00	1,553.60
40*	366.70	438.40	510.10	581.70	652.20	724.00	795.60	865.00	936.70	1,015.40	1,078.90	1,143.60	1,229.30	1,292.70	1,372.70	1,436.10	1,502.00	1,579.50	1,724.00
44*	404.30	481.80	561.80	639.40	718.10	796.90	875.50	953.20	1,031.90	1,116.40	1,188.20	1,257.50	1,351.50	1,422.00	1,510.10	1,579.50	1,668.80	1,735.80	1,895.70
48*	440.70	526.60	613.50	699.20	782.80	867.40	955.50	1,038.90	1,125.90	1,217.60	1,297.50	1,372.70	1,473.70	1,553.60	1,646.50	1,724.00	1,819.30	1,895.70	2,067.20

\*Oversize charges will apply

**LOGOS SMALLER THAN 10" X 10" CAN BE PRICED AS A LETTER USING THE MAXIMUM DIMENSION**  
**LOGOS LARGER THAN SIZES SHOWN OR CONTAINING 31+ PIECES/CUTOUTS**  
**EMAIL: [Signage@GeminiMade.com](mailto:Signage@GeminiMade.com)**

# 1" Thick Acrylic Logos

## PRICE PER LOGO - STANDARD MOUNTING & INSTALL PATTERN INCLUDED

SIZE	10"	12"	14"	16"	18"	20"	22"	24"	26"	28"	30"*	32"*	34"*	36"*	38"*	40"*	42"*	44"*	48"*
10"	\$121.10	\$141.00	\$162.30	\$176.30	\$191.60	\$210.40	\$236.30	\$263.30	\$289.20	\$315.00	\$334.90	\$353.80	\$381.90	\$401.90	\$426.70	\$447.80	\$466.60	\$491.30	\$536.00
11	131.60	152.80	177.50	192.80	211.50	233.90	259.80	289.20	317.30	344.40	366.70	390.20	420.80	440.70	467.80	490.10	512.50	538.30	588.80
12	141.00	166.90	191.60	210.40	231.50	255.00	283.30	316.20	345.60	376.10	400.80	424.30	457.20	479.60	510.10	533.60	558.20	587.60	640.50
13	151.60	179.90	206.90	226.90	250.40	277.40	306.80	340.80	374.90	406.70	433.70	459.60	493.60	519.50	552.30	577.10	604.10	634.60	692.20
14	162.30	191.60	222.20	245.70	269.20	298.50	332.70	366.70	401.90	437.20	466.60	493.60	531.20	558.20	592.30	621.70	648.70	682.90	745.10
15	168.10	202.20	235.00	263.30	291.50	319.70	354.90	393.70	431.30	466.60	497.20	526.60	568.80	597.10	634.60	664.00	694.60	731.00	799.10
16	176.30	210.40	245.70	280.90	310.30	340.80	379.70	419.60	458.30	497.20	531.20	561.80	605.20	635.90	675.70	707.50	739.20	779.20	850.90
17	183.40	221.00	258.50	295.00	329.10	363.20	403.20	446.60	487.70	528.80	564.10	597.10	642.90	675.70	719.20	751.00	786.30	827.40	902.60
18	191.60	231.50	269.20	310.30	347.90	384.30	428.90	472.50	516.00	559.50	595.80	632.30	679.40	714.60	760.40	795.60	832.10	875.50	955.50
19	201.00	240.90	282.00	324.40	365.60	407.80	451.30	497.20	544.20	590.00	630.00	666.40	718.10	755.70	800.40	838.00	876.80	922.50	1,007.20
20	210.40	255.00	298.50	340.80	384.30	430.20	474.80	524.20	572.30	620.60	661.70	701.60	755.70	794.50	843.90	881.40	921.40	970.80	1,058.90
21	222.20	266.80	315.00	359.70	404.30	451.30	499.50	550.10	601.70	651.10	693.40	735.70	791.00	833.30	885.00	924.90	967.30	1,017.80	1,111.80
22	236.30	283.30	332.70	379.70	428.90	474.80	523.00	575.80	628.70	680.50	727.50	768.60	828.50	873.30	927.30	969.50	1,014.30	1,065.90	1,163.40
23	249.20	298.50	350.30	398.40	450.20	499.50	550.10	603.00	657.00	713.40	760.40	803.90	866.10	910.80	967.30	1,013.00	1,058.90	1,114.20	1,215.20
24	263.30	316.20	366.70	419.60	472.50	524.20	575.80	628.70	685.20	742.70	793.30	839.10	903.80	950.80	1,008.40	1,056.60	1,104.70	1,162.30	1,268.10
26	289.20	345.60	401.90	458.30	516.00	572.30	628.70	685.20	742.70	803.90	857.90	908.50	976.70	1,029.50	1,091.80	1,143.60	1,195.20	1,258.70	1,372.70
30*	334.90	400.80	466.60	531.20	595.80	661.70	727.50	793.30	857.90	928.40	988.40	1,045.90	1,125.90	1,185.80	1,258.70	1,317.50	1,377.40	1,449.10	1,581.90
36*	401.90	479.60	558.20	635.90	714.60	794.50	873.30	950.80	1,029.50	1,114.20	1,185.80	1,255.20	1,349.20	1,419.70	1,506.60	1,578.40	1,650.00	1,735.80	1,895.70
40*	447.80	533.60	621.70	707.50	795.60	881.40	969.50	1,056.60	1,143.60	1,236.30	1,317.50	1,393.90	1,499.60	1,578.40	1,674.70	1,752.30	1,831.10	1,927.30	2,102.50
44*	491.30	587.60	682.90	779.20	875.50	970.80	1,065.90	1,162.30	1,258.70	1,361.00	1,449.10	1,532.50	1,648.90	1,735.80	1,841.60	1,927.30	2,034.30	2,119.00	2,312.90
48*	536.00	640.50	745.10	850.90	955.50	1,058.90	1,163.40	1,268.10	1,372.70	1,484.40	1,581.90	1,674.70	1,799.30	1,895.70	2,009.60	2,102.50	2,218.90	2,312.90	2,522.00

\*Oversize charges will apply

**LOGOS SMALLER THAN 10" X 10" CAN BE PRICED AS A LETTER USING THE MAXIMUM DIMENSION**  
**LOGOS LARGER THAN SIZES SHOWN OR CONTAINING 31+ PIECES/CUTOUTS**  
**EMAIL: [Signage@GeminiMade.com](mailto:Signage@GeminiMade.com)**



# 1-1/2" Thick Acrylic Logos

## PRICE PER LOGO - STANDARD MOUNTING & INSTALL PATTERN INCLUDED

SIZE	10"	12"	14"	16"	18"	20"	22"	24"	26"	28"	30"*	32"*	34"*	36"*	38"*	40"*	42"*	44"*	46"*	48"*
10"	\$205.70	\$243.30	\$278.50	\$307.90	\$340.80	\$377.30	\$418.40	\$461.90	\$506.60	\$548.80	\$585.30	\$619.40	\$665.20	\$701.60	\$744.00	\$779.20	\$815.60	\$857.90	\$892.00	\$935.50
11"	224.50	265.70	305.60	339.70	377.30	416.10	460.70	509.00	557.10	604.10	642.90	679.40	732.20	771.00	818.00	856.80	895.50	942.50	980.20	1,029.50
12"	243.30	289.20	333.80	371.40	411.30	453.70	504.20	554.70	606.50	658.10	700.50	741.60	795.60	839.10	890.90	933.20	975.40	1,028.30	1,069.40	1,121.20
13"	260.90	311.40	359.70	401.90	446.60	492.50	546.50	601.70	657.00	709.90	758.00	801.50	862.60	909.70	964.90	1,009.50	1,056.60	1,111.80	1,156.40	1,212.80
14"	278.50	333.80	386.70	432.60	479.60	531.20	588.80	647.60	706.40	765.10	815.60	862.60	929.70	977.80	1,037.80	1,087.10	1,136.40	1,195.20	1,244.60	1,304.50
15"	295.00	352.60	410.20	461.90	514.80	568.80	630.00	692.20	756.90	819.10	873.30	923.80	994.30	1,047.20	1,111.80	1,163.40	1,216.30	1,279.80	1,331.60	1,397.40
16"	307.90	371.40	432.60	493.60	550.10	607.60	672.20	739.20	806.30	874.40	930.80	986.00	1,060.10	1,116.40	1,184.70	1,241.10	1,297.50	1,364.50	1,420.90	1,490.20
17"	324.40	391.40	457.20	520.70	585.30	646.40	714.60	786.30	856.80	928.40	988.40	1,045.90	1,125.90	1,185.80	1,258.70	1,317.50	1,377.40	1,450.20	1,507.90	1,581.90
18"	340.80	411.30	479.60	550.10	619.40	685.20	758.00	832.10	906.10	980.20	1,045.90	1,107.10	1,191.70	1,256.30	1,331.60	1,393.90	1,457.20	1,533.60	1,597.10	1,673.50
19"	358.40	432.60	505.30	577.10	650.00	722.70	800.40	877.90	956.70	1,035.40	1,103.60	1,169.30	1,257.50	1,323.30	1,405.60	1,471.40	1,537.30	1,618.30	1,684.20	1,766.40
20"	377.30	453.70	531.20	607.60	685.20	761.60	841.50	922.50	1,006.00	1,089.40	1,161.20	1,229.30	1,321.00	1,392.60	1,477.20	1,547.80	1,618.30	1,702.90	1,772.30	1,858.10
21"	396.10	477.20	558.20	639.40	720.50	800.40	883.80	970.80	1,056.60	1,143.60	1,218.70	1,290.50	1,388.00	1,462.00	1,551.30	1,625.40	1,699.40	1,787.50	1,860.40	1,952.10
22"	418.40	504.20	588.80	672.20	758.00	841.50	924.90	1,016.50	1,105.90	1,198.70	1,276.30	1,350.40	1,451.40	1,531.40	1,625.40	1,701.80	1,778.20	1,873.30	1,948.60	2,042.60
23"	439.60	530.10	617.00	706.40	794.50	881.40	971.90	1,061.30	1,156.40	1,251.60	1,333.90	1,412.60	1,519.60	1,600.60	1,699.40	1,778.20	1,859.20	1,956.70	2,036.70	2,134.20
24"	461.90	554.70	647.60	739.20	832.10	922.50	1,016.50	1,108.30	1,205.80	1,304.50	1,391.50	1,473.70	1,585.40	1,670.00	1,772.30	1,855.70	1,940.30	2,041.30	2,124.90	2,227.00
26"	506.60	606.50	706.40	806.30	906.10	1,006.00	1,105.90	1,205.80	1,305.70	1,413.90	1,506.60	1,596.00	1,715.80	1,807.50	1,917.90	2,009.60	2,100.10	2,210.60	2,299.90	2,411.50
28"	548.80	658.10	765.10	874.40	980.20	1,089.40	1,198.70	1,304.50	1,413.90	1,517.90	1,621.30	1,717.70	1,846.40	1,945.70	2,065.00	2,162.60	2,260.70	2,379.90	2,476.30	2,596.20
30"*	585.30	700.50	815.60	930.80	1,045.90	1,161.20	1,276.30	1,391.50	1,506.60	1,621.30	1,735.80	1,839.20	1,976.70	2,083.70	2,211.70	2,315.10	2,420.90	2,549.10	2,652.40	2,780.60
32"*	619.40	741.60	862.60	986.00	1,107.10	1,229.30	1,350.40	1,473.70	1,596.00	1,717.70	1,839.20	1,977.40	2,106.50	2,222.60	2,358.80	2,469.40	2,581.40	2,718.00	2,828.10	2,965.20
34"*	665.20	795.60	929.70	1,060.10	1,191.70	1,321.00	1,451.40	1,585.40	1,715.80	1,846.40	1,976.70	2,106.50	2,234.30	2,365.40	2,504.90	2,623.20	2,741.70	2,886.90	3,003.70	3,149.60
36"*	701.60	839.10	977.80	1,116.40	1,256.30	1,392.60	1,531.40	1,670.00	1,807.50	1,945.70	2,083.70	2,222.60	2,365.40	2,499.70	2,652.40	2,777.10	2,901.60	3,055.50	3,178.90	3,334.10
38"*	744.00	890.90	1,037.80	1,184.70	1,331.60	1,477.20	1,625.40	1,772.30	1,917.90	2,065.00	2,211.70	2,358.80	2,504.90	2,652.40	2,791.90	2,930.50	3,062.80	3,224.20	3,354.20	3,518.10
40"*	779.20	933.20	1,087.10	1,241.10	1,393.90	1,547.80	1,701.80	1,855.70	2,009.60	2,162.60	2,315.10	2,469.40	2,623.20	2,777.10	2,930.50	3,083.80	3,223.70	3,392.80	3,529.20	3,701.90
42"*	815.60	975.40	1,136.40	1,297.50	1,457.20	1,618.30	1,778.20	1,940.30	2,100.10	2,260.70	2,420.90	2,581.40	2,741.70	2,901.60	3,062.80	3,223.70	3,392.80	3,562.70	3,705.60	3,886.00
44"*	857.90	1,028.30	1,195.20	1,364.50	1,533.60	1,702.90	1,873.30	2,041.30	2,210.60	2,379.90	2,549.10	2,718.00	2,886.90	3,055.50	3,224.20	3,392.80	3,562.70	3,732.50	3,881.80	4,069.80
46"*	892.00	1,069.40	1,244.60	1,420.90	1,597.10	1,772.30	1,948.60	2,124.90	2,299.90	2,476.30	2,652.40	2,828.10	3,003.70	3,178.90	3,354.20	3,529.20	3,705.60	3,881.80	4,068.00	4,254.90
48"*	935.50	1,121.20	1,304.50	1,490.20	1,673.50	1,858.10	2,042.60	2,227.00	2,411.50	2,596.20	2,780.60	2,965.20	3,149.60	3,334.10	3,518.10	3,701.90	3,886.00	4,069.80	4,254.90	4,440.00

\*Oversize charges will apply

**LOGOS SMALLER THAN 10" X 10" CAN BE PRICED AS A LETTER USING THE MAXIMUM DIMENSION**  
**LOGOS LARGER THAN SIZES SHOWN OR CONTAINING 31+ PIECES/CUTOUTS**  
**EMAIL: [Signage@GeminiMade.com](mailto:Signage@GeminiMade.com)**

▶ 10", 8", 4" & 3" H x 3/8" thick dark blue and custom green letters.



▼ 18", 10" & 8" H x 1/4" thick white letters and reverse cut logo.







## **PLASTIC MEDIA THAT POPS**

Only Gemini offers the range of plastic solutions for any dimensional application. From our crisp, injection molded letters that mimic more costly metal letters to our multi-depth, affordable formed plastic signage.





## DIMENSIONAL PLASTIC

Formed plastic letters in multiple sizes and type styles

Injection molded letters with sharper details and edges

Tough, UV stable and guaranteed for life

Automotive quality, painting options

Industry-leading lead times

### LOW COST, HIGH IMPACT

The next generation of Gemini's formed plastic technology is here. Today's formed plastic signage is made from tough UV stable material that is completely recyclable, and features the versatility to form complex, multi-level signage or individual logos and letters that let you transform a 2D design into a high-impact, dimensional experience. Gemini also offers the crisp edges and smooth returns of dimensional injection molded letters in architectural styles that replicate the look of cast metal letters and offer reduced weight for easier mounting.

#### WHEN ORDERING

PLEASE SPECIFY:

- Install Environment
- Size (Height)
- Color Selection
- Vector Art or Standard Font
- Depth
- Install Method

## Dimensional Plastic Colors:

 2025 Black Approx PMS Black	 5687 White Approx PMS White	 8886 Metallic Silver* Approx PMS 420	 2718 Ivory Approx PMS 7499	 4660 Desert Sand Approx PMS 7506	 0209 Grey Approx PMS 423	 4310 Dove Grey Approx PMS 431	 8090 Safety Green Approx PMS 809
 2037 Lemon Yellow Approx PMS 102	 2000 Yellow Approx PMS 108	 0217 Citrus Yellow Approx PMS 606	 0218 Sundance Yellow Approx PMS 116	 0254 Mango Approx PMS 137	 2119 Orange Approx PMS 021	 2662 Red-Orange Approx PMS 485	 0256 Rampart Orange Approx PMS 172
 2793 Red Approx PMS 185	 1875 Brick Red Approx PMS 7623	 2280 Black Cherry Approx PMS 1817	 2240 Maroon Approx PMS 202	 2410 Magenta Approx PMS 241	 2287 Purple Approx PMS 2695	 0246 Violet Toner Approx PMS 2725	 2767 Midnight Blue Approx PMS 5395
 2050 Dark Blue Approx PMS 281	 2860 Medium Blue Approx PMS 286	 3000 Blue Approx PMS 300	 2648 Light Blue Approx PMS 2995	 5425 Marine Reef Blue Approx PMS 5425	 3210 Teal Blue Approx PMS 321	 3555 Spring Green Approx PMS 355	 0222 Emerald Green Approx PMS 356
 0259 Federal Green Approx PMS 350	 2108 Light Green Approx PMS 3415	 2030 Dark Green Approx PMS 3435	 2162 Hunter Green Approx PMS 3308	 0400 Brilliant Gold Approx PMS 7556	 2756 Metallic Gold* Approx PMS 465	 0401 Aztec Gold Approx PMS 2317	 0253 Copper Approx PMS 7600
 0402 Aztec Copper Approx PMS 7599	 2418 Brown Approx PMS 476	 0312 Medium Bronze* Approx PMS 2335	 0314 Old Copper* Approx PMS 2334	 3130 Duranodic Bronze* Approx PMS 2336	 1315 Dark Oxide Approx PMS 447		

\* Indicates colors that do not have a full gloss finish.

## Custom Paint Color:



It's easy to request custom color matching! Simply tell us the paint number or name and brand of paint you'd like us to match (e.g. PMS 186 or Sherwin-Williams Boathouse Blue) and we will obtain a mixing formula at no cost to you.

Don't have a paint name or number and still need a color exactly matched? Please send us a sample (sample item must be at least 3" x 3") and our paint lab will run it through an exacting color match process. Exact color matching from a sample is \$200.

## Premium Finishes



Polished Chrome  
(Formed price x 2.5)

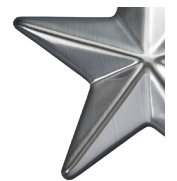

Brushed Chrome  
(Formed price x 3)

**Standard Mounting Options:**

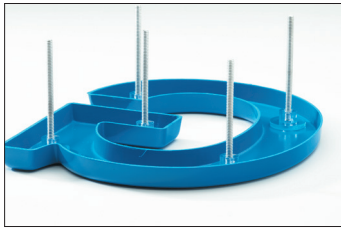

**2a-Stud**

*Threaded blocks are solvent bonded to the letter backs to receive a 10-24 stud. Silicone adhesive is applied to the studs and into the drilled holes when installing. Price as listed including drill pattern.*



**2b-Pad**

*Threaded blocks are solvent bonded to the letter backs to receive the perforated pad. Silicone adhesive is used to adhere the perforated pads to the installation surface. Spacing guides are available for this installation. \*\* Most letters 9" and under will have perforated pads bonded directly to the letter back and will have a slight stand-off. Price as listed including stencil guide.*

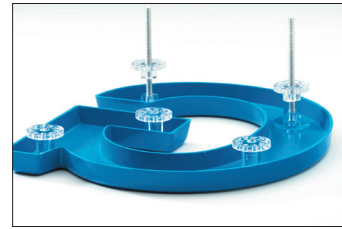

**2c-Combination**

*Threaded blocks are solvent bonded to the letter backs. The top portion of the letter receives stud through pads and the bottom pad only. Mounting procedure is the same as 2a Stud with the addition of securing pads to the installation surface with silicone. Drilling pattern is required for this installation. \*\* Most letters 9" and under will have perforated pads bonded directly to the letter back and will have a stand-off. Price as listed including drill pattern.*

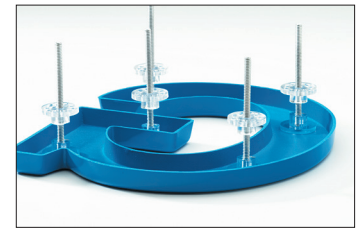

**2d-Combination All**

*Threaded blocks are solvent bonded to the letter backs. All mount locations receive a stud through pad. Mounting procedure is the same as 2a Stud with the addition of securing pads to the installation surface with silicone. Price as listed including drill pattern.*

**Optional Mounting:**



**2f-Flange - ADD 5%**

*Letters are produced with a minimum 1/4" wide visible plastic flange, all around letter, to allow for installing with screws (not supplied). Stud, Combination, Combination All and Pad mounts can be added to this mounting at the +5%. Flange and Flange with Pad mount includes stencil guide. Flange with studs, combination and combination all includes drill pattern.*



**Standard mounting In-Line for rail, brick or block**

*Price as Listed*



**STANDARD FORMED SYMBOLS**

# Most Popular Formed Plastic Letters

**PRICE PER LETTER - STANDARD MOUNTING & INSTALL PATTERN INCLUDED**



**Arial Bold**

**PRICE PER LETTER W/PATTERN**

SIZE	APPROX. DEPTH	PRICE
4"	3/4"	\$14.30
6	3/4	17.20
8	3/4	23.10
9	3/4	26.70
10	1	28.20
12	1	33.90
15	1	47.40
18	1-1/2	63.10
24	1-1/2	101.60
30 †	1-1/2	162.50
36 †	1-1/2	234.60

† Oversize shipping will apply



**Architectural**

*Prismatic Face*

**PRICE PER LETTER W/PATTERN**

SIZE	APPROX. DEPTH	PRICE
4"*	3/4"	\$14.30
6	3/4	17.20
8	3/4	23.10
9	3/4	26.70
10	1	28.20
12	1	33.90
15	1	47.40
18	1-1/2	63.10
24	1-1/2	101.60
30 †	1-1/2	162.50
36 †	1-1/2	234.60

\* Upper Case Only  
† Oversize shipping will apply



**Futura Bold**

**PRICE PER LETTER W/PATTERN**

SIZE	APPROX. DEPTH	PRICE
4"	3/4"	\$14.30
6	3/4	17.20
8	3/4	23.10
9	3/4	26.70
10	1	28.20
12	1	33.90
15	1	47.40
18	1-1/2	63.10
24	1-1/2	101.60
30 †	1-1/2	162.50
36 †	1-1/2	234.60

† Oversize shipping will apply



**Goudy Extra Bold**

**PRICE PER LETTER W/PATTERN**

SIZE	APPROX. DEPTH	PRICE
4"	3/4"	\$14.30
6	3/4	17.20
8	3/4	23.10
9	3/4	26.70
10	1	28.20
12	1	33.90
15	1	47.40
18	1-1/2	63.10
24	1-1/2	101.60
30 †	1-1/2	162.50
36 †	1-1/2	234.60

† Oversize shipping will apply



**Helvetica**

**PRICE PER LETTER W/PATTERN**

SIZE	APPROX. DEPTH	PRICE
4"	3/4"	\$14.30
6	3/4	17.20
8	3/4	23.10
9	3/4	26.70
10	1	28.20
12	1	33.90
15	1	47.40
18	1-1/2	63.10
24	1-1/2	101.60
30 †	1-1/2	162.50
36 †	1-1/2	234.60

† Oversize shipping will apply



**Helvetica Bold**

**PRICE PER LETTER W/PATTERN**

SIZE	APPROX. DEPTH	PRICE
4"	3/4"	\$14.30
6	3/4	17.20
8	3/4	23.10
9	3/4	26.70
10	1	28.20
12	1	33.90
15	1	47.40
18	1-1/2	63.10
24	1-1/2	101.60
30 †	1-1/2	162.50
36 †	1-1/2	234.60

† Oversize shipping will apply



**Times New Roman**

**PRICE PER LETTER W/PATTERN**

SIZE	APPROX. DEPTH	PRICE
4"	3/4"	\$14.30
6	3/4	17.20
8	3/4	23.10
9	3/4	26.70
10	1	28.20
12	1	33.90
15	1	47.40
18	1-1/2	63.10
24	1-1/2	101.60
30 †	1-1/2	162.50
36 †	1-1/2	234.60

† Oversize shipping will apply



**Times Bold**

**PRICE PER LETTER W/PATTERN**

SIZE	APPROX. DEPTH	PRICE
4"	3/4"	\$14.30
6	3/4	17.20
8	3/4	23.10
9	3/4	26.70
10	1	28.20
12	1	33.90
15	1	47.40
18	1-1/2	63.10
24	1-1/2	101.60
30 †	1-1/2	162.50
36 †	1-1/2	234.60

† Oversize shipping will apply

STANDARD FORMED  
SYMBOLS

## Other Standard Formed Plastic Letters

PRICE PER LETTER - STANDARD MOUNTING & INSTALL PATTERN INCLUDED

PRICE PER LETTER

6"	9"	12"	15"	18"	24"
\$17.20	\$26.70	\$33.90	\$47.40	\$63.10	\$101.60

Lower Case is 90% of corresponding Upper Case price. Punctuation is 33% of upper case price.

AVANT GARDE MEDIUM 

ABCDEFGHIJKLMNOPQRSTUVWXYZ  
abcdefghijklmnopqrstuvwxyz 1234567890/&-.,

BENGUIAT 

ABCDEFGHIJKLMNOPQRSTUVWXYZ  
abcdefghijklmnopqrstuvwxyz 1234567890/&-.,

BRUSH SCRIPT 

*ABCDEFGHIJKLMNOPQRSTUVWXYZ*  
*abcdefghijklmnopqrstuvwxyz 1234567890/&-.,*

CASLON ADBOLD   
\* Upper case only

ABCDEFGHIJKLMNOPQRSTUVWXYZ  
1234567890/&-.,

CENTURY SCHOOLBOOK BOLD   
\* Upper case only

ABCDEFGHIJKLMNOPQRSTUVWXYZ  
1234567890/&~.,

CLARENDON FORTUNE BOLD 

ABCDEFGHIJKLMNOPQRSTUVWXYZ  
abcdefghijklmnopqrstuvwxyz 1234567890/&-.,

COOPER BLACK 

**ABCDEFGHIJKLMNOPQRSTUVWXYZ**  
**abcdefghijklmnopqrstuvwxyz 1234567890/&-.,**

COPPERPLATE\*   
\* Upper case only

ABCDEFGHIJKLMNOPQRSTUVWXYZ  
1234567890/&-.,

# Other Standard Formed Plastic Letters

**PRICE PER LETTER - STANDARD MOUNTING & INSTALL PATTERN INCLUDED**

PRICE PER LETTER					
6"	9"	12"	15"	18"	24"
\$17.20	\$26.70	\$33.90	\$47.40	\$63.10	\$101.60

Lower Case is 90% of corresponding Upper Case price. Punctuation is 33% of upper case price.

FUTURA 

**ABCDEFGHIJKLMNOPQRSTUVWXYZ**  
**abcdefghijklmnopqrstuvwxyz 1234567890/&-.,**

FUTURA  
 CONDENSED 

**ABCDEFGHIJKLMNOPQRSTUVWXYZ**  
**abcdefghijklmnopqrstuvwxyz 1234567890/&-.,**

GARAMOND  
 BOLD ITALIC 

***ABCDEFGHIJKLMNOPQRSTUVWXYZ***  
***abcdefghijklmnopqrstuvwxyz 1234567890/&-.,***

GARAMOND  
 BOLD ROUND 

**ABCDEFGHIJKLMNOPQRSTUVWXYZ**  
**abcdefghijklmnopqrstuvwxyz 1234567890/&-.,**

GIL SANS BOLD 

**ABCDEFGHIJKLMNOPQRSTUVWXYZ**  
**abcdefghijklmnopqrstuvwxyz 1234567890/&-.,**

HELVETICA MEDIUM  
 CONDENSED 

**ABCDEFGHIJKLMNOPQRSTUVWXYZ**  
**abcdefghijklmnopqrstuvwxyz 1234567890/&-.,**

HELVETICA MEDIUM  
 ITALIC 

***ABCDEFGHIJKLMNOPQRSTUVWXYZ***  
***abcdefghijklmnopqrstuvwxyz 1234567890/&-.,***

HELVETICA  
 ROUND 

**ABCDEFGHIJKLMNOPQRSTUVWXYZ**  
**abcdefghijklmnopqrstuvwxyz 1234567890/&-.,**



STANDARD FORMED SYMBOLS

## Other Standard Formed Plastic Letters

PRICE PER LETTER - STANDARD MOUNTING & INSTALL PATTERN INCLUDED

PRICE PER LETTER

6"	9"	12"	15"	18"	24"
\$17.20	\$26.70	\$33.90	\$47.40	\$63.10	\$101.60

Lower Case is 90% of corresponding Upper Case price. Punctuation is 33% of upper case price.

MICROGRAMMA  
BOLD EXTENDED 

**ABCDEFGHIJKLMNOPQRSTUVWXYZ**  
**1234567890/&-,.**

OPTIMA 

ABCDEFGHIJKLMNOPQRSTUVWXYZ  
abcdefghijklmnopqrstuvwxyz 1234567890/&-,.

OPTIMA  
SEMIBOLD 

**ABCDEFGHIJKLMNOPQRSTUVWXYZ**  
**abcdefghijklmnopqrstuvwxyz 1234567890/&-,.**

ROMAN  
CLASSIC 

**ABCDEFGHIJKLMNOPQRSTUVWXYZ**  
**1234567890/&-,.**

ROMAN  
ROUND 

**ABCDEFGHIJKLMNOPQRSTUVWXYZ**  
**abcdefghijklmnopqrstuvwxyz 1234567890/&-,.**

STANDARD  
BLOCK 

**ABCDEFGHIJKLMNOPQRSTUVWXYZ**  
**abcdefghijklmnopqrstuvwxyz 1234567890 / &-,.**

TRAJAN  
BOLD 

**ABCDEFGHIJKLMNOPQRSTUVWXYZ**  
**1234567890/&-,.**

UNIVERS 67 

**ABCDEFGHIJKLMNOPQRSTUVWXYZ**  
**abcdefghijklmnopqrstuvwxyz 1234567890/&-,.**

# Custom Formed Flat Face Letters

PRICE PER LETTER-Standard mounting & pattern included

PRICE PER LETTER W/PATTERN



Flat Face

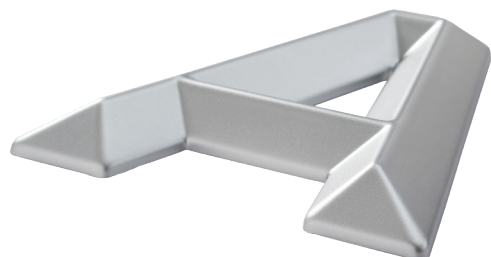

Prismatic



Round

**Pricing Notes:**

- Price includes stud, pad, combination or combination all mount and installation pattern / stencil
- Price includes any standard color shown on page 105 or your own custom color
- Lower case is 90% of the corresponding Upper Case price
- Small punctuation, such as a comma, period and dash are 33% of the Upper Case price

SIZE	APPROX. DEPTH	FLAT FACE	PRISMATIC or ROUND
4"	3/4"	\$23.60	\$29.50
5	3/4	25.60	32.00
6	3/4	28.10	35.13
7	3/4	31.20	39.00
8	3/4	34.30	42.88
9	3/4	40.60	50.75
10	1	47.40	59.25
11	1	51.50	64.38
12	1	55.10	68.88
13	1-1/2	59.40	74.25
14	1-1/2	64.50	80.63
15	1-1/2	69.00	86.25
16	1-1/2	78.60	98.25
17	1-1/2	86.50	108.13
18	1-1/2	94.80	118.50
19	1-1/2	107.00	133.75
20	1-1/2	116.20	145.25
21	1-1/2	127.10	158.88
22	1-1/2	139.70	174.63
23	1-1/2	151.00	188.75
24	1-1/2	166.30	207.88
25	1-1/2	180.80	226.00
26	1-1/2	197.30	246.63
27	1-1/2	209.60	262.00
28	1-1/2	224.90	281.13
29	1-1/2	239.90	299.88
30*	1-1/2	254.80	318.50
31*	1-1/2	260.00	325.00
32*	1-1/2	275.60	344.50
33*	1-1/2	303.50	379.38
34*	1-1/2	307.90	384.88
35*	1-1/2	324.80	406.00
36*	1-1/2	356.00	445.00
37*	1-1/2	359.30	449.13
38*	1-1/2	377.00	471.25
39*	1-1/2	411.60	514.50
40*	1-1/2	413.40	516.75
41*	1-1/2	432.70	540.88
42*	1-1/2	469.80	587.25
43*	1-1/2	470.90	588.63
44*	1-1/2	490.30	612.88
45*	1-1/2	509.50	636.88
46*	1-1/2	531.00	663.75
47*	1-1/2	552.00	690.00
48*	2	596.00	745.00
49+	EMAIL FOR QUOTE		

\*Oversize shipping charges will apply

1.800.538.8377

# Flat Face Formed Plastic Logos

Logos with 3 or more pieces may have additional charges

## PRICE PER LOGO-Standard mounting & pattern included

SIZE	12" & under	13	14	15	16	17	18	19	20	21	22	23	24	25	26	28	30*	32*	34*	36*
12" & under	\$70	\$72	\$80	\$84	\$92	\$93	\$102	\$105	\$115	\$116	\$127	\$132	\$139	\$143	\$147	\$158	\$170	\$182	\$195	\$204
13"	72	79	85	91	95	101	106	114	119	126	129	135	143	148	154	167	177	189	202	212
14"	80	85	94	95	106	108	121	128	133	140	146	153	158	167	173	185	198	212	225	238
15	84	91	95	102	108	118	123	130	135	144	150	156	165	173	177	190	204	217	231	245
16	92	95	106	108	122	123	139	143	151	153	167	168	182	188	198	205	226	240	258	272
17	93	101	108	118	123	132	140	147	155	162	170	178	187	194	201	216	231	247	263	277
18	102	106	121	123	139	140	154	158	170	173	188	196	204	210	222	238	254	272	290	306
19	105	114	128	130	143	147	158	165	174	182	190	199	212	216	225	240	258	275	294	309
20	115	119	133	135	151	155	170	174	189	196	208	213	226	233	245	265	284	301	320	341
21	116	126	140	144	153	162	173	182	196	201	213	219	235	238	247	272	290	306	322	348
22	127	129	146	150	167	170	188	190	208	213	229	236	249	253	271	290	311	333	353	371
23	132	135	153	156	168	178	196	199	213	219	236	239	254	260	275	295	316	338	360	381
24	139	143	158	165	182	187	204	212	226	235	249	254	272	278	295	316	341	361	384	408
25	143	148	167	173	188	194	210	216	233	238	253	260	278	284	301	321	346	368	393	415
26	147	154	173	177	198	201	222	225	245	247	271	275	295	301	319	343	367	391	417	440
27	154	158	177	183	202	208	229	233	252	258	277	281	301	306	323	348	371	397	422	455
28	158	167	185	190	205	216	238	240	265	272	290	295	316	321	343	370	395	422	449	474
29	165	173	192	198	211	225	245	251	272	275	295	301	321	326	348	373	401	426	453	479
30*	170	177	198	204	226	231	254	258	284	290	311	316	341	346	367	395	423	452	480	510
31*	177	183	204	211	235	239	263	267	290	295	316	321	345	349	371	402	429	456	486	513
32*	182	189	212	217	240	247	272	275	301	306	333	338	361	368	391	422	452	484	511	541
33*	188	196	219	225	250	254	279	285	307	313	338	343	368	371	396	428	457	487	515	546
34*	195	202	225	231	258	263	290	294	320	322	353	360	384	393	417	449	480	511	534	563
35*	199	206	231	238	263	270	295	301	326	333	360	366	393	396	422	452	485	515	538	569
36*	204	212	238	245	272	277	306	309	341	348	371	381	408	415	440	474	510	541	563	609
37*	210	219	245	252	279	285	313	319	347	350	381	385	415	418	446	479	512	548	568	621
38*	215	225	251	258	286	292	321	326	359	361	394	401	429	433	463	497	535	561	588	643
39*	222	230	260	264	294	299	330	335	366	370	402	405	433	440	470	506	550	575	597	655
40*	226	236	265	272	301	308	341	343	375	380	416	425	452	457	490	512	565	588	621	677
41*	231	240	272	279	308	316	348	353	381	390	422	433	456	464	494	517	573	591	630	692
42*	238	247	278	285	315	321	357	360	395	397	433	440	474	479	514	538	590	616	655	712
44*	249	258	290	299	333	338	371	377	416	418	455	466	498	512	538	570	622	645	689	744
46*	261	271	304	312	347	355	390	395	432	437	478	490	521	529	562	605	649	693	737	779
48*	272	283	316	323	348	369	408	419	452	462	498	508	541	553	586	634	677	721	768	811
49+	EMAIL FOR QUOTE																			

\*Oversize shipping charges will apply





# Round or Prismatic Formed Plastic Logos

Logos with 3 or more pieces may have additional charges

## PRICE PER LOGO-Standard mounting & pattern included

SIZE	12" & under	13	14	15	16	17	18	19	20	21	22	23	24	25	26	28	30*	32*	34*	36*
12" & under	\$88	\$90	\$100	\$105	\$115	\$117	\$128	\$132	\$144	\$145	\$159	\$165	\$174	\$179	\$184	\$198	\$213	\$228	\$244	\$255
13"	90	99	107	114	119	127	133	143	149	158	162	169	179	185	193	209	222	237	253	265
14"	100	107	118	119	133	135	152	160	167	175	183	192	198	209	217	232	248	265	282	298
15	105	114	119	128	135	148	154	163	169	180	188	195	207	217	222	238	255	272	289	307
16	115	119	133	135	153	154	174	179	189	192	209	210	228	235	248	257	283	300	323	340
17	117	127	135	148	154	165	175	184	194	203	213	223	234	243	252	270	289	309	329	347
18	128	133	152	154	174	175	193	198	213	217	235	245	255	263	278	298	318	340	363	383
19	132	143	160	163	179	184	198	207	218	228	238	249	265	270	282	300	323	344	368	387
20	144	149	167	169	189	194	213	218	237	245	260	267	283	292	307	332	355	377	400	427
21	145	158	175	180	192	203	217	228	245	252	267	274	294	298	309	340	363	383	403	435
22	159	162	183	188	209	213	235	238	260	267	287	295	312	317	339	363	389	417	442	464
23	165	169	192	195	210	223	245	249	267	274	295	299	318	325	344	369	395	423	450	477
24	174	179	198	207	228	234	255	265	283	294	312	318	340	348	369	395	427	452	480	510
25	179	185	209	217	235	243	263	270	292	298	317	325	348	355	377	402	433	460	492	519
26	184	193	217	222	248	252	278	282	307	309	339	344	369	377	399	429	459	489	522	550
27	193	198	222	229	253	260	287	292	315	323	347	352	377	383	404	435	464	497	528	569
28	198	209	232	238	257	270	298	300	332	340	363	369	395	402	429	463	494	528	562	593
29	207	217	240	248	264	282	307	314	340	344	369	377	402	408	435	467	502	533	567	599
30*	213	222	248	255	283	289	318	323	355	363	389	395	427	433	459	494	529	565	600	638
31*	222	229	255	264	294	299	329	334	363	369	395	402	432	437	464	503	537	570	608	642
32*	228	237	265	272	300	309	340	344	377	383	417	423	452	460	489	528	565	605	639	677
33*	235	245	274	282	313	318	349	357	384	392	423	429	460	464	495	535	572	609	644	683
34*	244	253	282	289	323	329	363	368	400	403	442	450	480	492	522	562	600	639	668	704
35*	249	258	289	298	329	338	369	377	408	417	450	458	492	495	528	565	607	644	673	712
36*	255	265	298	307	340	347	383	387	427	435	464	477	510	519	550	593	638	677	704	762
37*	263	274	307	315	349	357	392	399	434	438	477	482	519	523	558	599	640	685	710	777
38*	269	282	314	323	358	365	402	408	449	452	493	502	537	542	579	622	669	702	735	804
39*	278	288	325	330	368	374	413	419	458	463	503	507	542	550	588	633	688	719	747	819
40*	283	295	332	340	377	385	427	429	469	475	520	532	565	572	613	640	707	735	777	847
41*	289	300	340	349	385	395	435	442	477	488	528	542	570	580	618	647	717	739	788	865
42*	298	309	348	357	394	402	447	450	494	497	542	550	593	599	643	673	738	770	819	890
44*	312	323	363	374	417	423	464	472	520	523	569	583	623	640	673	713	778	807	862	930
46*	327	339	380	390	434	444	488	494	540	547	598	613	652	662	703	757	812	867	922	974
48*	340	354	395	404	435	462	510	524	565	578	623	635	677	692	733	793	847	902	960	1,014
49+	EMAIL FOR QUOTE																			

# Standard Injection Molded Plastic Letters

**PRICE PER LETTER - STANDARD MOUNTING & INSTALL PATTERN INCLUDED**



**ARCHITECTURAL**  
UPPER CASE ONLY - *Prismatic Face*

**PRICE PER LETTER  
W/PATTERN**

SIZE	APPROX. DEPTH	PRICE
2" †	1/2"	\$10.60
3	1/2	12.00
4	5/8	12.90
6	5/8	15.50
8	3/4	20.80
10	3/4	25.40
12	3/4	30.50

† Plain mount only



**Helvetica**

**PRICE PER LETTER  
W/PATTERN**

SIZE	APPROX. DEPTH	PRICE
2" *	3/8"	\$10.60
3	1/2	12.00
4	5/8	12.90
5 *	3/4	13.90
6	3/4	15.50
8	3/4	20.80
9 *	3/4	24.00
10	1	25.40
12	1	30.50
15	1-1/4	42.70
18	1-1/2	56.80

\* Upper case only



**Times Bold**

**PRICE PER LETTER  
W/PATTERN**

SIZE	APPROX. DEPTH	PRICE
2" *	3/8"	\$10.60
3 *	1/2	12.00
4	5/8	12.90
6	3/4	15.50
8	3/4	20.80
10 *	1	25.40
12	1	30.50
15 *	1-1/4	42.70
18	1-1/2	56.80

\* Upper case only

**PRISMATIC FACE INJECTION MOLDED**

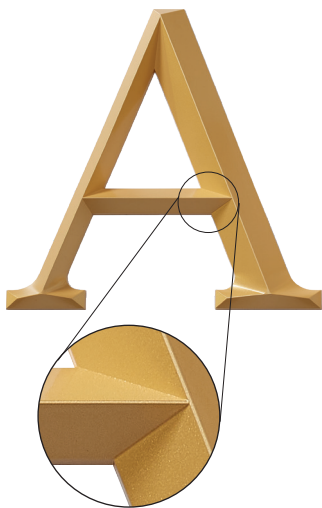

**PRISMATIC FACE FORMED**

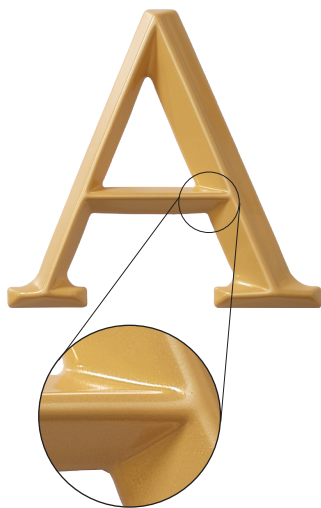

**FLAT FACE INJECTION MOLDED**



**FLAT FACE FORMED**



**Pricing Notes:**

- Price includes stud, pad, combination or combination all mount and installation pattern / stencil
- Price includes any standard color shown on page 105 or your own custom color
- Lower case, where available, is 90% of the corresponding Upper Case price
- Small punctuation, such as a comma, period and dash are 33% of the Upper Case price





## SIGN UP FOR BIG DRAMA

Whether in metals, plastics or tandems of both materials, Gemini handcrafts its dimensional illuminated letters and logos using high quality, UL-approved and maintenance-free LED lighting modules that are pre-wired for mounting convenience.





## BRILLIANT IMPACT

Illuminated signage has come a long way from the days of complex neon and fluorescent channel letters. Gemini has advanced and powerful solutions with integrated, energy efficient, no-maintenance LED modules designed for even the most challenging environments and mounting surfaces.



## HALO LIT LETTERS & LOGOS

Minimum Height	Maximum Height	Maximum Size	Depth/Thickness	Application	Material
3"	95"	46 1/2" x 95"; larger sizes available as multi-piece	Custom depths can be specified: 1" up to 4"	Indoor or Outdoor Use	Stainless steel, aluminum or plastic



## FACE LIT LETTERS & LOGOS

Minimum Height	Maximum Height	Maximum Size	Depth/Thickness	Application	Material
6"	95"	46 1/2" x 95"; larger sizes available as multi-piece	Custom depths can be specified: 1" up to 6"	Indoor or Outdoor Use	Stainless steel, aluminum or plastic



## SPECIALTY LIT LETTERS & LOGOS

Minimum Height	Maximum Height	Maximum Size	Depth/Thickness	Application	Material
6"	36"	36" x 36"	1", 1-1/2" & based on letter height	Indoor or Outdoor Use	Plastic





## **DRAMA. IMPACT. 24/7 VISIBILITY.**

When you want to make a powerful impression around the clock, you need illuminated letters and logo solutions from Gemini. Design options include a number of formed and fabricated plastic and metal materials applied to halo-, face-, edge- and specialty illuminated applications in turnkey, pre-wired LED lit solutions.

1.800-538-8377





# HALO ILLUMINATED

Illuminated letters and logos from 3" to 100"+

Metal or plastic fabrication

5 standard serviceable LED colors plus multi-color RGB

Pre-wired, UL approved with integrated LEDs

Industry-leading lead times

## **SUBTLE AND POWERFUL**

The dramatic impressions created by a halo-lit design communicates exceptional sophistication, allowing you to design large-scale without overwhelming the environment. With Gemini's brilliant, low-profile LEDs, even the narrowest strokes and details can house our compact modules to provide even illumination and appearance with no lighting dead zones. Choose from fabricated aluminum and stainless steel faces to our elegant trimless models, acrylic faces or select formed plastic or cast metal products, all with brilliant halo lighting.











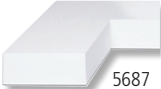

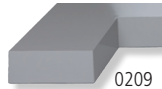

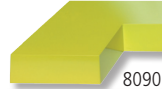









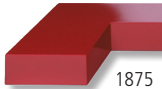





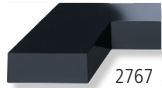



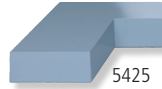

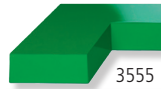
### **WHEN ORDERING**

PLEASE SPECIFY:

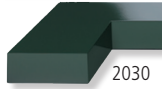
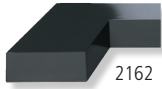
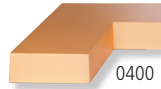
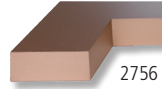
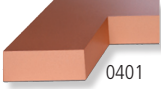
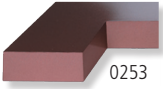
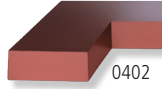
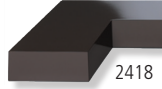
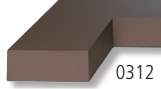
- Product Type
- LED Color
- Size (Height) & Thickness
- Finish or Color
- Vector Art or Standard Font
- Install Method



## Standard Painted Colors:

 5687 White Approx PMS White	 2718 Ivory Approx PMS 7499	 4660 Desert Sand Approx PMS 7506	 0209 Grey Approx PMS 423	 4310 Dove Grey Approx PMS 431	 8090 Safety Green Approx PMS 809
 2037 Lemon Yellow Approx PMS 102	 2000 Yellow Approx PMS 108	 0217 Citrus Yellow Approx PMS 606	 0218 Sundance Yellow Approx PMS 116	 0254 Mango Approx PMS 137	 2119 Orange Approx PMS 021
 2662 Red-Orange Approx PMS 485	 0256 Rampart Orange Approx PMS 172	 2793 Red Approx PMS 185	 1875 Brick Red Approx PMS 7623	 2280 Black Cherry Approx PMS 1817	 2240 Maroon Approx PMS 202
 2410 Magenta Approx PMS 241	 2287 Purple Approx PMS 2695	 0246 Violet Toner Approx PMS 2725	 2767 Midnight Blue Approx PMS 5395	 2050 Dark Blue Approx PMS 281	 2860 Medium Blue Approx PMS 286
 3000 Blue Approx PMS 300	 2648 Light Blue Approx PMS 2995	 5425 Marine Reef Blue Approx PMS 5425	 3210 Teal Blue Approx PMS 321	 3555 Spring Green Approx PMS 355	 0222 Emerald Green Approx PMS 356
 0259 Federal Green Approx PMS 350	 2108 Light Green Approx PMS 3415	 2030 Dark Green Approx PMS 3435	 2162 Hunter Green Approx PMS 3308	 0400 Brilliant Gold Approx PMS 7556	 2756 Metallic Gold* Approx PMS 465
 0401 Aztec Gold Approx PMS 2317	 0253 Copper Approx PMS 7600	 0402 Aztec Copper Approx PMS 7599	 2418 Brown Approx PMS 476	 0312 Medium Bronze* Approx PMS 2335	 0314 Old Copper* Approx PMS 2334
 3130 Duranodic Bronze* Approx PMS 2336	 1315 Dark Oxide Approx PMS 447	 8886 Metallic Silver* Approx PMS 420	 2025 Black Approx PMS Black		



## Custom Paint Color:

It's easy to request custom color matching! Simply tell us the paint number or name and brand of paint you'd like us to match (e.g. PMS 186 or Sherwin-Williams Boathouse Blue) and we will obtain a mixing formula at no cost to you.

Don't have a paint name or number and still need a color exactly matched? Please send us a sample (sample item must be at least 3" x 3") and our paint lab will run it through an exacting color match process. Exact color matching from a sample is \$200.

### Stainless Steel Alloy 304:

Vertical grain is standard on all fabricated letters & logos. Horizontal grain can be requested. Mixed face and return finishes - email for quote.

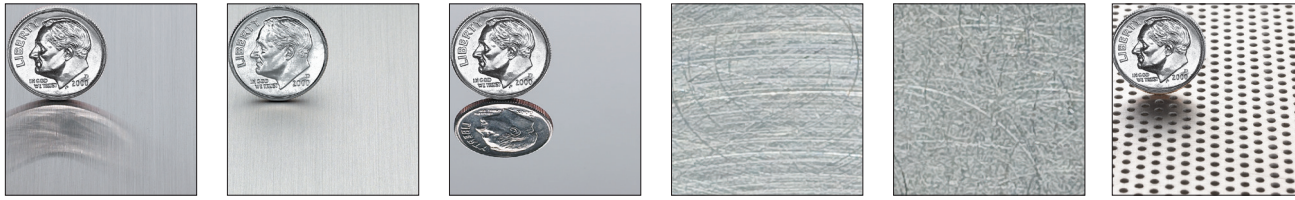

Brushed      #4 Brushed      Polished      Random Arc      Orbital      Perforated

### Titanium Coated 304 Stainless Steel



Brushed Gold      Brushed Copper      Brushed Bronze



Brushed Black

### Stainless Steel Alloy 316



Brushed      #4 Brushed



Polished

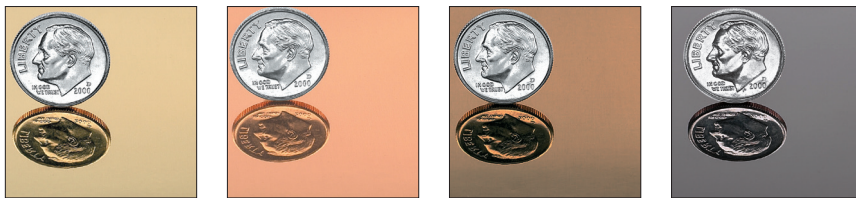

Polished Gold      Polished Copper      Polished Bronze      Polished Black

### Aluminum Alloy 5052:



Brushed

### Aluminum Anodized

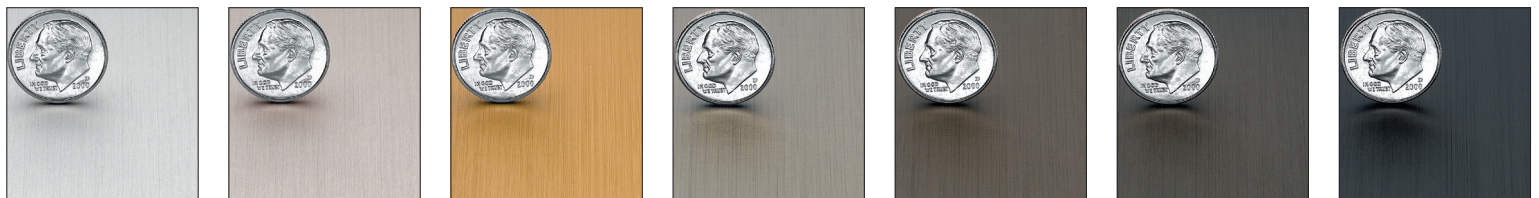

Clear      Champagne      Gold      Light Bronze      Medium Bronze      Dark Bronze      Black

### LED Color Options:



White      Warm White      Red      Green      Blue



\* Additional charges apply

# Fabricated Stainless Steel - Halo Lit

INCLUDES STANDARD MOUNTING, PATTERN & LED PACKAGE



## Stainless Steel Options

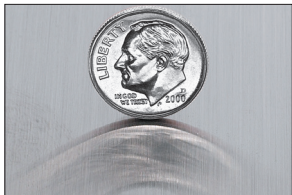

Brushed



Painted

## LED Options

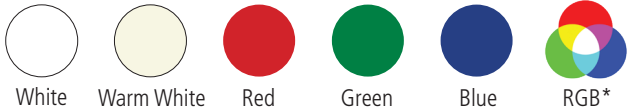

White

Warm White

Red

Green

Blue

RGB\*  
(programmable custom color)

\* Additional charges apply

## Mini-Stainless Steel - Halo

PRICE PER LETTER		
SIZE	1.5" DEEP BRUSHED OR PAINTED	2" DEEP BRUSHED OR PAINTED
3"	\$253	\$259
4	266	272
5	280	286



### Pricing Notes

- 3" - Upper case only
- Lower case letters are 90% of price listed
- Punctuation - small pieces; such as comma, period and dash are 33% of upper case price
- Flush screws on returns
- Premium LEDs designed for small letters



## PRICE PER LETTER INCLUDING LED PACKAGE

SEE PAGE 119 FOR LED PACKAGE DETAILS

SIZE	1" DEEP	1.5" DEEP	2" DEEP	2.5" DEEP	3" DEEP	4" DEEP	5" DEEP	6" DEEP
	BRUSHED OR PAINTED	BRUSHED OR PAINTED	BRUSHED OR PAINTED	BRUSHED OR PAINTED	BRUSHED OR PAINTED	BRUSHED OR PAINTED	BRUSHED OR PAINTED	BRUSHED OR PAINTED
6"	\$131	\$144	\$161					
7	140	154	172					
8	153	168	186					
9	168	181	200	\$211	\$219	\$240		
10	181	195	216	227	237	258		
11	194	209	228	241	252	276		
12	206	223	241	256	270	300		
13	220	237	259	275	290	322	\$355	
14	239	256	279	296	312	346	381	
15	259	272	301	319	335	371	407	
16	277	291	315	335	352	391	434	\$474
17	294	312	335	357	376	419	465	511
18	312	332	365	386	405	446	487	528
19	337	356	387	406	422	458	500	546
20	354	381	417	435	451	486	522	560
21	372	405	443	460	474	506	540	571
22	396	431	468	485	501	535	571	605
23	419	459	502	520	535	570	605	638
24	457	499	546	565	581	617	656	698
25	503	549	602	620	636	673	712	756
26	546	592	640	659	675	712	755	808
27	586	636	685	705	723	763	807	856
28	622	674	719	739	757	797	840	887
29	654	704	746	767	786	827	878	930
30*	679	728	765	788	807	851	903	966
31*			784	807	828	875	927	987
32*			804	831	856	910	967	1,036
33*			825	853	879	935	1,002	1,073
34*			857	890	921	985	1,052	1,119
35*			891	926	959	1,027	1,093	1,160
36*			925	961	995	1,065	1,136	1,206
37+	EMAIL FOR QUOTE							

LETTER HEIGHT - MAX DIMENSION

\*Oversize charges will apply

### Additional Pricing Notes:

- Lower case letters are 90% of price listed
- Punctuation - small pieces; such as comma, period and dash are 33% of upper case price
- Bottom or Top Stud email for quote
- Face / return painted separate +15%
- **NEW!** Block, serif & script styles - SAME PRICE



# Fabricated Aluminum - Halo Lit

INCLUDES STANDARD MOUNTING, PATTERN & LED PACKAGE



## PRICE PER LETTER INCLUDING LED PACKAGE

### Aluminum Options



Brushed



Painted

### LED Options



White



Warm White



Red



Green



Blue



RGB\*  
(programmable custom color)

\* Additional charges apply

### LED Package Includes:

UL Listed with Sign Section labels, lead wires/cables and power supplies  
 Standard leads are 3-wire on metal letters & 2-wire on plastic letters; 10' long wire / cables.  
 Optional longer leads or individual wires available.  
 Systems are 12VDC, Class 2 power supplies.  
 Wiring diagrams and instructions are provided with LED lit sets.  
 UL label location - optional location, per customer request.  
 Appropriate mounting hardware and patterns for install  
 5 year warranty on Gemini electrical components

LETTER HEIGHT - MAX DIMENSION

SIZE	1" DEEP BRUSHED OR PAINTED	1.5" DEEP BRUSHED OR PAINTED	2" DEEP BRUSHED OR PAINTED	3" DEEP BRUSHED OR PAINTED	3.5" DEEP BRUSHED OR PAINTED	4" DEEP BRUSHED OR PAINTED	5" DEEP BRUSHED OR PAINTED	6" DEEP BRUSHED OR PAINTED
< 16"	EMAIL FOR QUOTE							
16"	\$246	\$259	\$280	\$298	\$323	\$348	\$386	\$421
17	262	278	298	318	346	373	413	454
18	278	295	325	343	370	397	433	469
19	300	317	344	361	384	407	444	485
20	315	339	371	387	410	432	464	498
21	331	360	394	409	430	450	480	508
22	352	383	416	431	454	476	508	538
23	373	408	446	462	485	507	538	567
24	406	444	485	502	525	548	583	620
25	447	488	535	551	575	598	633	672
26	485	526	569	586	610	633	671	718
27	521	565	609	627	653	678	717	761
28	553	599	639	657	683	708	746	788
29	581	626	663	682	709	735	780	826
30*	603	647	680	700	728	756	802	858
31*			697	717	747	777	824	877
32*			714	738	774	809	859	920
33*			733	758	795	831	890	953
34*			762	791	833	875	935	994
35*			792	823	868	912	971	1,031
36*			822	854	900	946	1,009	1,071
37*			859	891	939	987	1,053	1,118
38*			898	930	980	1,030	1,099	1,167
39*			939	970	1,023	1,075	1,147	1,218
40*			982	1,012	1,067	1,122	1,197	1,271
41*			1,027	1,056	1,114	1,171	1,249	1,326
42*			1,074	1,102	1,162	1,222	1,303	1,384
43*			1,123	1,150	1,213	1,275	1,360	1,444
44*			1,174	1,200	1,265	1,330	1,419	1,507
45*			1,227	1,252	1,320	1,388	1,481	1,572
46*				1,306	1,377	1,448	1,545	1,640
48*				1,363	1,437	1,511	1,612	1,711
50*				1,548	1,632	1,715	1,831	1,943
52*				1,685	1,776	1,866	1,993	2,115
54*				1,834	1,933	2,031	2,169	2,301
56*				1,996	2,104	2,211	2,361	2,504
58*				2,172	2,290	2,407	2,569	2,725
60*				2,364	2,492	2,619	2,796	2,966
61+	EMAIL FOR QUOTE							

\*Oversize charges will apply

# Fabricated Stainless Steel - Prepped for Halo Lit - NO LEDs

INCLUDES STANDARD MOUNTING & PATTERN

## Stainless Steel Options



Brushed



Painted

## PRICE PER LETTER DOES NOT INCLUDING LED PACKAGE

SIZE	1" DEEP	1.5" DEEP	2" DEEP	2.5" DEEP	3" DEEP	4" DEEP	5" DEEP	6" DEEP
	BRUSHED OR PAINTED	BRUSHED OR PAINTED	BRUSHED OR PAINTED	BRUSHED OR PAINTED	BRUSHED OR PAINTED	BRUSHED OR PAINTED	BRUSHED OR PAINTED	BRUSHED OR PAINTED
6"	\$86	\$95	\$110					
7	93	104	119					
8	99	110	126					
9	112	123	140	\$152	\$161	\$180		
10	125	135	154	166	175	190		
11	134	145	163	174	182	202		
12	144	157	175	188	198	220		
13	154	168	192	204	214	237	\$257	
14	169	186	212	227	239	266	288	
15	186	197	229	244	257	284	306	
16	195	209	244	260	274	295	319	\$347
17	206	222	258	276	292	317	342	375
18	222	241	280	298	313	329	353	385
19	241	256	298	317	334	346	367	398
20	255	273	314	332	348	363	382	410
21	267	291	324	338	350	375	393	420
22	284	307	339	354	366	392	412	439
23	301	328	357	372	385	413	435	464
24	335	366	393	407	418	445	464	511
25	368	402	424	440	453	480	504	554
26	395	429	457	476	492	516	551	598
27	422	457	484	503	520	556	591	637
28	448	485	507	527	545	584	625	666
29	466	503	526	547	565	604	650	698
30*	484	523	545	566	585	624	670	720
31*			564	587	607	648	695	746
32*			582	606	628	673	722	777
33*			602	628	651	698	750	808
34*			623	649	673	726	779	839
35*			642	671	698	754	809	874
36*			667	697	725	782	840	908
37+	EMAIL FOR QUOTE							

LETTER HEIGHT - MAX DIMENSION

### Additional Pricing Notes:

- Lower case letters are 90% of price listed
- Punctuation - small pieces; such as comma, period and dash are 33% of upper case price
- Bottom or Top Stud email for quote
- Face / return painted separate +15%
- **NEW!** Block, serif & script styles - SAME PRICE

\*Oversize charges will apply

# Fabricated Aluminum - Prepped for Halo Lit - NO LEDs

INCLUDES STANDARD MOUNTING & PATTERN

## Aluminum Options



Brushed



Painted

### Additional Pricing Notes:

- Lower case letters are 90% of price listed
- Punctuation - small pieces; such as comma, period and dash are 33% of upper case price
- Bottom or Top Stud email for quote
- Face / return painted separate +15%
- **NEW!** Block, serif & script styles - SAME PRICE

## PRICE PER LETTER DOES NOT INCLUDING LED PACKAGE

SIZE	1" DEEP BRUSHED OR PAINTED	1.5" DEEP BRUSHED OR PAINTED	2" DEEP BRUSHED OR PAINTED	3" DEEP BRUSHED OR PAINTED	3.5" DEEP BRUSHED OR PAINTED	4" DEEP BRUSHED OR PAINTED	5" DEEP BRUSHED OR PAINTED	6" DEEP BRUSHED OR PAINTED
< 16"	EMAIL FOR QUOTE							
16"	\$172	\$184	\$215	\$241	\$251	\$260	\$296	\$321
17	181	196	227	257	268	279	317	347
18	196	212	246	275	283	290	327	357
19	212	225	262	294	299	304	340	369
20	225	240	276	306	313	319	354	380
21	235	256	285	308	319	330	364	389
22	250	270	298	322	334	345	382	407
23	265	289	314	339	351	363	403	430
24	295	322	346	368	380	391	430	473
25	324	354	373	398	410	422	467	513
26	348	377	402	433	444	454	510	554
27	371	402	426	457	473	489	547	590
28	394	427	446	479	497	514	579	617
29	410	442	463	497	514	531	602	646
30*	426	460	479	514	532	549	620	666
31*			496	534	552	570	643	691
32*			512	552	572	592	668	719
33*			529	572	593	614	694	748
34*			548	592	615	638	721	777
35*			564	614	639	663	749	809
36*			586	637	662	687	777	840
37*			617	668	694	720	813	878
38*			650	701	728	755	850	918
39*			684	735	764	792	889	960
40*			720	771	801	831	930	1,004
41*			758	809	840	871	973	1,050
42*			798	848	881	913	1,018	1,098
43*			840	889	923	957	1,065	1,148
44*			884	932	968	1,003	1,114	1,200
45*			930	977	1,015	1,052	1,165	1,254
46*				1,024	1,064	1,103	1,219	1,311
48*				1,126	1,169	1,212	1,334	1,432
50*				1,238	1,286	1,333	1,459	1,565
52*				1,361	1,413	1,465	1,596	1,710
54*				1,496	1,553	1,610	1,745	1,868
56*				1,644	1,707	1,770	1,909	2,041
58*				1,806	1,876	1,945	2,087	2,229
60*				1,984	2,061	2,137	2,282	2,435
61+	EMAIL FOR QUOTE							

LETTER HEIGHT - MAX DIMENSION





**PRICE PER LETTER INCLUDING LED PACKAGE**

SEE PAGE 121 FOR LED PACKAGE DETAILS

**BRUSHED OR PAINTED**

**Trimless Fabricated Stainless Steel - Halo Lit**  
**INCLUDES STANDARD MOUNTING, PATTERN & LED PACKAGE**



**Stainless Steel Options**



Brushed



Painted

**LED Options**



\* Additional charges apply

LETTER HEIGHT - MAX DIMENSION

SIZE	1" DEEP			2" DEEP			3" DEEP		
	ACRYLIC REVEAL			ACRYLIC REVEAL			ACRYLIC REVEAL		
	1/4"	1/2"	3/4"	1/4"	1/2"	3/4"	1/4"	1/2"	3/4"
6"	\$204	\$216	\$234	\$226	\$239	\$257			
7"	219	232	251	245	259	278			
8"	234	248	268	259	274	294			
9"	266	281	304	291	308	331	\$327	\$345	\$369
10"	289	306	331	314	332	357	350	369	395
11"	311	329	356	336	355	382	373	393	421
12"	332	351	380	359	379	408	395	417	446
13"	354	374	405	384	406	436	429	452	484
14"	385	407	441	425	449	483	472	498	533
15"	416	440	476	451	477	512	501	528	565
16"	444	470	508	471	498	535	525	554	592
17"	467	494	535	506	535	575	563	594	635
18"	503	532	576	548	579	623	610	643	688
19"	545	576	624	590	624	670	648	683	731
20"	576	609	659	620	655	704	676	713	763
21"	602	637	689	648	685	736	708	747	799
22"	642	679	735	686	725	779	748	789	844
23"	679	718	777	731	773	830	795	838	897
24"	724	766	829	785	830	892	851	898	960
25"	776	821	888	841	889	955	910	960	1,027
26"	832	880	952	901	952	1,024	975	1,028	1,100
27"	882	933	1,010	951	1,005	1,080	1,026	1,082	1,158
28"	932	986	1,067	998	1,055	1,134	1,077	1,136	1,215
29"	983	1,040	1,125	1,054	1,114	1,197	1,132	1,194	1,277
30"*	1,038	1,098	1,188	1,110	1,173	1,261	1,186	1,251	1,338
31"*	1,093	1,156	1,251	1,165	1,231	1,323	1,236	1,304	1,395
32"*	1,148	1,214	1,314	1,220	1,289	1,386	1,292	1,363	1,458
33"*	1,202	1,271	1,376	1,274	1,346	1,447	1,342	1,415	1,514
34"*	1,258	1,331	1,440	1,328	1,404	1,509	1,396	1,472	1,575
35"*	1,308	1,383	1,497	1,384	1,463	1,572	1,455	1,535	1,642
36"*	1,358	1,436	1,555	1,436	1,518	1,631	1,510	1,593	1,704
37"+	EMAIL FOR QUOTE								

\*Oversize charges will apply

**Mini-Trimless Stainless Steel**  
**PRICE PER LETTER**

	1.5" DEEP			2" DEEP			2-1/2" DEEP			3" DEEP		
	ACRYLIC REVEAL			ACRYLIC REVEAL			ACRYLIC REVEAL			ACRYLIC REVEAL		
	1/4"	1/2"	3/4"	1/4"	1/2"	3/4"	1/4"	1/2"	3/4"	1/4"	1/2"	3/4"
3"	\$290	\$303	\$315	\$297	\$310	\$323						
4	306	320	333	311	325	338						
5	321	335	349	328	343	357						
6	337	352	366	344	359	374						
7	354	370	385	361	377	393						
8	372	389	404	380	397	413	\$395	\$413	\$429	\$423	\$442	\$461
9	390	407	424	398	416	433	415	434	451	444	464	483
10	410	428	446	418	437	455	436	455	474	467	488	508
11	431	450	468	440	460	479	458	478	498	490	512	533
12	452	472	491	462	483	502	480	501	522	515	538	561
13	EMAIL FOR QUOTE											

**Mini-Trimless Pricing Notes**

- 3" - Upper case only
- Lower case letters are 90% of price listed
- Punctuation - small pieces; such as comma, period and dash are 33% of upper case price
- Flush screws on returns
- Premium LEDs designed for small letters
- Narrow strokes available - down to 0.65"
- Larger sizes available - Email for quote

1.800.538.8377

# Trimless Fabricated Aluminum - Halo Lit

INCLUDES STANDARD MOUNTING, PATTERN & LED PACKAGE



## Aluminum Options



Brushed



Painted

## LED Options

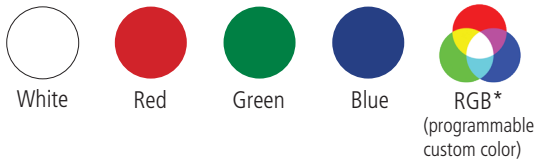

\* Additional charges apply

### Pricing Notes:

- Lower case letters are 90% of price listed
- Punctuation - small pieces; such as comma, period and dash are 33% of upper case price
- Bottom or Top Stud email for quote
- Face / return painted separate +15%
- Standard lead is a 3-wire cable, 10' long
- **NEW!** Block, serif & script styles - SAME PRICE

### LED Package Includes:

UL Listed with Sign Section labels, lead wires/cables and power supplies  
 Standard leads are 3-wire on metal letters & 2-wire on plastic letters;  
 10' long wire / cables.  
 Optional longer leads or individual wires available.  
 Systems are 12VDC, Class 2 power supplies.  
 Wiring diagrams and instructions are provided with LED lit sets.  
 UL label location - optional location, per customer request.  
 Appropriate mounting hardware and patterns for install  
 5 year warranty on Gemini electrical components



## PRICE PER LETTER INCLUDING LED PACKAGE

### BRUSHED OR PAINTED

SIZE	1" DEEP			2" DEEP			3" DEEP		
	ACRYLIC REVEAL			ACRYLIC REVEAL			ACRYLIC REVEAL		
	1/4"	1/2"	3/4"	1/4"	1/2"	3/4"	1/4"	1/2"	3/4"
16"	\$413	\$440	\$476	\$439	\$467	\$506	\$489	\$517	\$559
17"	435	463	501	471	501	542	524	554	599
18"	468	498	539	510	543	587	568	601	649
19"	507	540	584	549	584	632	603	638	689
20"	536	571	617	577	614	665	629	666	719
21"	560	596	645	603	642	695	659	697	753
22"	598	637	689	638	679	735	696	736	795
23"	632	673	728	680	723	783	740	783	846
24"	674	718	776	731	778	842	792	838	905
25"	722	769	832	783	833	902	847	896	968
26"	774	824	891	838	892	965	907	960	1,037
27"	821	874	946	885	942	1,019	955	1,010	1,091
28"	867	923	999	929	988	1,070	1,002	1,060	1,145
29"	915	974	1,054	981	1,044	1,130	1,053	1,114	1,203
30"*	966	1,029	1,113	1,033	1,099	1,190	1,103	1,167	1,261
31"*	1,017	1,083	1,171	1,084	1,153	1,249	1,150	1,217	1,314
32"*	1,068	1,137	1,230	1,135	1,208	1,307	1,202	1,272	1,374
33"*	1,118	1,191	1,288	1,185	1,261	1,365	1,249	1,322	1,427
34"*	1,170	1,246	1,348	1,236	1,315	1,424	1,299	1,374	1,485
35"*	1,217	1,296	1,402	1,288	1,370	1,484	1,354	1,433	1,547
36"*	1,263	1,345	1,455	1,336	1,421	1,539	1,405	1,487	1,606
37"*							1,462	1,547	1,671
38"*							1,522	1,610	1,739
39"*							1,584	1,676	1,810
40"*							1,649	1,744	1,884
41"*							1,716	1,815	1,961
42"*							1,786	1,889	2,041
43"*							1,859	1,966	2,124
44"*							1,935	2,046	2,211
45"*							2,014	2,129	2,301
46"*							2,096	2,216	2,395
47"*							2,181	2,306	2,492
48"*							2,270	2,400	2,593
49"+	EMAIL FOR QUOTE								

LETTER HEIGHT - MAX DIMENSION

\*Oversize charges will apply

# Trimless Lit Acrylic (3/8" Illuminated Reveal) - Halo Lit L-900

INCLUDES STANDARD MOUNTING, PATTERN & LED PACKAGE

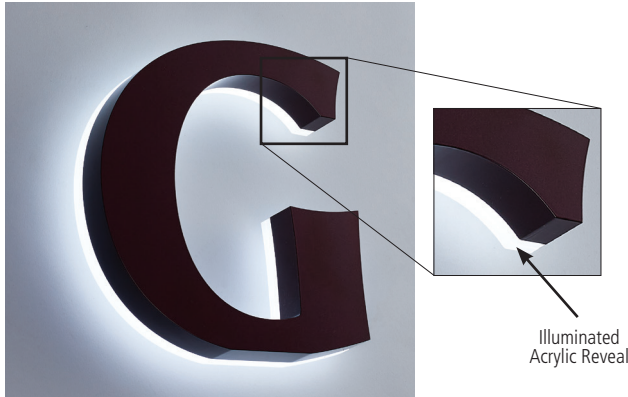

## Acrylic Options



Painted

## LED Options



White

Red

Green

Blue

### LED Package Includes:

UL Listed with Sign Section labels, lead wires/cables and power supplies  
 Standard leads are 3-wire on metal letters & 2-wire on plastic letters;  
 10' long wire / cables.  
 Optional longer leads or individual wires available.  
 Systems are 12VDC, Class 2 power supplies.  
 Wiring diagrams and instructions are provided with LED lit sets.  
 UL label location - optional location, per customer request.  
 Appropriate mounting hardware and patterns for install  
 5 year warranty on Gemini electrical components



## PRICE PER LETTER INCLUDING LED PACKAGE

		PAINTED 1-1/2" DEEP			
		3/8" ACRYLIC REVEAL	1/2" ACRYLIC REVEAL	3/4" ACRYLIC REVEAL	1" ACRYLIC REVEAL
Upper Case Only	SIZE 8"	\$328	\$360.80	\$410.00	\$475.60
	9	352	387.20	440.00	510.40
	10	375	412.50	468.75	543.75
	11	393	432.30	491.25	569.85
LETTER HEIGHT - MAX DIMENSION	12	424	466.40	530.00	614.80
	13	469	515.90	586.25	680.05
	14	505	555.50	631.25	732.25
	15	541	595.10	676.25	784.45
	16	565	621.50	706.25	819.25
	17	612	673.20	765.00	887.40
	18	637	700.70	796.25	923.65
	19	741	815.10	926.25	1,074.45
	20	795	874.50	993.75	1,152.75
	21	831	914.10	1,038.75	1,204.95
	22	868	954.80	1,085.00	1,258.60
	23	902	992.20	1,127.50	1,307.90
	24	941	1,035.10	1,176.25	1,364.45
	25+	EMAIL FOR QUOTE			

### Pricing Notes:

- Lower case letters are 90% of price listed
- Punctuation - small pieces; such as comma, period and dash are 33% of upper case price
- Bottom or Top Stud email for quote
- Face / return painted separate +15%
- Standard lead is a 2-wire cable, 10' long
- Detachable studs included
- Additional acrylic reveals available - Email for quote



# Lit Acrylic - Halo Lit L-1000

INCLUDES STANDARD MOUNTING, PATTERN & LED PACKAGE



## Acrylic Options



Painted

## LED Options



White

Warm White

Red

Green

Blue

### LED Package Includes:

UL Listed with Sign Section labels, lead wires/cables and power supplies  
 Standard leads are 3-wire on metal letters & 2-wire on plastic letters;  
 10' long wire / cables.  
 Optional longer leads or individual wires available.  
 Systems are 12VDC, Class 2 power supplies.  
 Wiring diagrams and instructions are provided with LED lit sets.  
 UL label location - optional location, per customer request.  
 Appropriate mounting hardware and patterns for install  
 5 year warranty on Gemini electrical components



## PRICE PER LETTER INCLUDING LED PACKAGE

		PAINTED 1-1/2" DEEP
		SIZE
Upper Case Only	8"	\$315
	9	336
	10	358
LETTER HEIGHT - MAX DIMENSION	11	376
	12	405
	13	448
	14	483
	15	518
	16	541
	17	587
	18	609
	19	709
	20	760
	21	795
	22	830
23	863	
24	900	
25+	EMAIL FOR QUOTE	

### Pricing Notes:

- Lower case letters are 90% of price listed
- Punctuation - small pieces; such as comma, period and dash are 33% of upper case price
- Bottom or Top Stud email for quote
- Face / return painted separate +15%
- Standard lead is a 2-wire cable, 10' long
- Detachable studs included

# Formed Plastic (GemLite) - Halo Lit G-200

INCLUDES STANDARD MOUNTING, PATTERN & LED PACKAGE



Flat return with no visible can



Stepped return with visible can



## Lit Formed Options



Painted

## LED Options

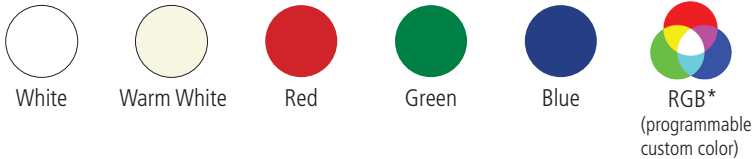

\* Additional charges apply

## PRICE PER LETTER INCLUDING LED PACKAGE PAINTED

SIZE	APPROX. DEPTH	FLAT RETURN	STEPPED RETURN
6"	1"	\$139	--
7	1	139	--
8	1 1/4	139	--
9	1 1/4	139	\$105
10	1 1/4	158	119
11	1 1/4	172	130
12	1 1/2	178	134
13	1 1/2	190	143
14	1 1/2	204	154
15	1 1/2	220	166
16	1 1/2	244	184
17	1 1/2	268	202
18	2	288	217
19	2	321	242
20	2	350	265
21	2	380	287
22	2	415	314
23	2	446	337
24	2	489	370
25	2	528	400
26	2	568	430
27	2	608	460
28	2	698	528
30	2	777	588
32	2	877	664
34	2	954	722
36	2	1,037	785
37+	EMAIL FOR QUOTE		

LETTER HEIGHT - MAX DIMENSION

### LED Package Includes:

UL Listed with Sign Section labels, lead wires/cables and power supplies  
 Standard leads are 3-wire on metal letters & 2-wire on plastic letters;  
 10' long wire / cables.  
 Optional longer leads or individual wires available.  
 Systems are 12VDC, Class 2 power supplies.  
 Wiring diagrams and instructions are provided with LED lit sets.  
 UL label location - optional location, per customer request.  
 Appropriate mounting hardware and patterns for install  
 5 year warranty on Gemini electrical components

### Pricing Notes:

- Lower case letters are 90% of price listed
- Punctuation - small pieces; such as comma, period and dash are 33% of upper case price
- Includes stud mounts with stand-offs
- Face / return painted separate +15%
- Standard lead is a 2-wire cable, 10' long
- Round or prismatic face add 15%

# Custom Cast Aluminum - Halo Lit Flat Face Letters

INCLUDES STANDARD MOUNTING, PATTERN & LED PACKAGE



## Aluminum Options



Brushed



Painted

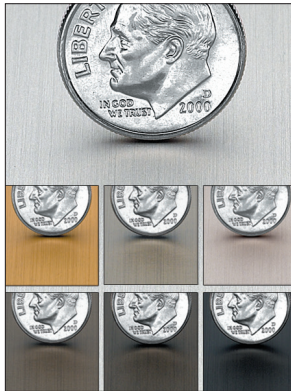

Anodized

Clear, Gold, Champagne, Light Bronze, Medium Bronze, Dark Bronze & Black

**Pricing Notes:**

- Lower case letters are 90% of price listed
- Punctuation - small pieces; such as comma, period and dash are 33% of upper case price
- Includes stud mounts with stand-offs
- Face / return painted separate +15%
- Standard lead is a 3-wire cable, 10' long
- Round or prismatic face email for quote

## PRICE PER LETTER INCLUDING LED PACKAGE

SIZE	APPROX. DEPTH	BRUSHED OR PAINTED	ANODIZED
12"	1"	\$294.00	\$367.50
13	1	326.00	407.50
14	1	367.00	458.75
15	1 1/4	418.00	522.50
16	1 1/4	438.00	547.50
17	1 1/4	479.00	598.75
18	1 1/2	505.00	631.25
19	1 1/2	538.00	672.50
20	1 1/2	570.00	712.50
21	1 1/2	625.00	781.25
22	1 1/2	654.00	817.50
23	1 1/2	691.00	863.75
24	1 1/2	814.00	1,017.50
25	1 1/2	984.00	1,230.00
26	1 1/2	1,063.00	1,328.75
27	1 1/2	1,133.00	1,416.25
28	1 1/2	1,204.00	1,505.00
29	1 1/2	1,271.00	1,588.75
30	1 1/2	1,345.00	1,681.25
31+		EMAIL FOR QUOTE	

LETTER HEIGHT - MAX DIMENSION

### LED Package Includes:

UL Listed with Sign Section labels, lead wires/cables and power supplies  
 Standard leads are 3-wire on metal letters & 2-wire on plastic letters;  
 10' long wire / cables.  
 Optional longer leads or individual wires available.  
 Systems are 12VDC, Class 2 power supplies.  
 Wiring diagrams and instructions are provided with LED lit sets.  
 UL label location - optional location, per customer request.  
 Appropriate mounting hardware and patterns for install  
 5 year warranty on Gemini electrical components

## LED Options



White



Warm White



Red



Green



Blue





## **THE GLOW OF SUCCESS**

The design impact of Gemini's expert fabrication of metal and plastic letters and logos are magnified by the dramatic effects of brilliant face lighting.



# FACE ILLUMINATED

Illuminated letters and logos from 6" to 68"

Metal or plastic fabrication

5 standard serviceable LED colors plus multi-color RGB

Pre-wired, UL approved with integrated LEDs

Industry-leading lead times

## VISIBILITY THAT DEMANDS ATTENTION











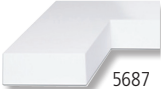

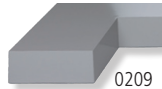

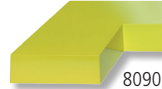









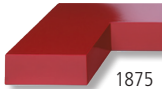





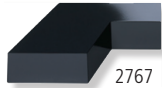



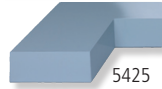

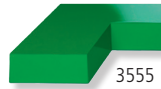
Retailers, company brands and organizations can display their brilliance around the clock with Gemini's face illuminated letters and logos. A step up from traditional channel letters, Gemini's solutions offer expertly-fabricated metal returns and high-quality diffused acrylic faces. Models are available in precision-fit, narrow trim, or the exceptional style of trimless finishing, including premium solid cast acrylic solutions.

### WHEN ORDERING

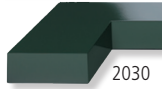
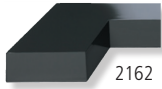
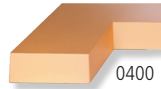
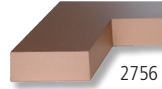
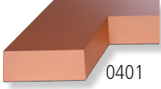
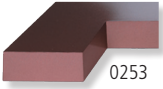
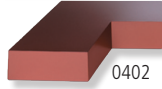
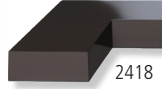
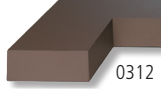
PLEASE SPECIFY:

- Product Type
- LED Color
- Size (Height) & Thickness
- Finish or Color Selection
- Vector Art or Standard Font
- Install Method

## Standard Painted Colors:

 5687 White Approx PMS White	 2718 Ivory Approx PMS 7499	 4660 Desert Sand Approx PMS 7506	 0209 Grey Approx PMS 423	 4310 Dove Grey Approx PMS 431	 8090 Safety Green Approx PMS 809
 2037 Lemon Yellow Approx PMS 102	 2000 Yellow Approx PMS 108	 0217 Citrus Yellow Approx PMS 606	 0218 Sundance Yellow Approx PMS 116	 0254 Mango Approx PMS 137	 2119 Orange Approx PMS 021
 2662 Red-Orange Approx PMS 485	 0256 Rampart Orange Approx PMS 172	 2793 Red Approx PMS 185	 1875 Brick Red Approx PMS 7623	 2280 Black Cherry Approx PMS 1817	 2240 Maroon Approx PMS 202
 2410 Magenta Approx PMS 241	 2287 Purple Approx PMS 2695	 0246 Violet Toner Approx PMS 2725	 2767 Midnight Blue Approx PMS 5395	 2050 Dark Blue Approx PMS 281	 2860 Medium Blue Approx PMS 286
 3000 Blue Approx PMS 300	 2648 Light Blue Approx PMS 2995	 5425 Marine Reef Blue Approx PMS 5425	 3210 Teal Blue Approx PMS 321	 3555 Spring Green Approx PMS 355	 0222 Emerald Green Approx PMS 356
 0259 Federal Green Approx PMS 350	 2108 Light Green Approx PMS 3415	 2030 Dark Green Approx PMS 3435	 2162 Hunter Green Approx PMS 3308	 0400 Brilliant Gold Approx PMS 7556	 2756 Metallic Gold* Approx PMS 465
 0401 Aztec Gold Approx PMS 2317	 0253 Copper Approx PMS 7600	 0402 Aztec Copper Approx PMS 7599	 2418 Brown Approx PMS 476	 0312 Medium Bronze* Approx PMS 2335	 0314 Old Copper* Approx PMS 2334
 3130 Duranodic Bronze* Approx PMS 2336	 1315 Dark Oxide Approx PMS 447	 8886 Metallic Silver* Approx PMS 420	 2025 Black Approx PMS Black		



## Custom Paint Color:

It's easy to request custom color matching! Simply tell us the paint number or name and brand of paint you'd like us to match (e.g. PMS 186 or Sherwin-Williams Boathouse Blue) and we will obtain a mixing formula at no cost to you.

Don't have a paint name or number and still need a color exactly matched? Please send us a sample (sample item must be at least 3" x 3") and our paint lab will run it through an exacting color match process. Exact color matching from a sample is \$200.



**Standard Alloys:**



Brushed Aluminum



Brushed Stainless Steel

**Other Aluminum & Stainless Steel Finishes**  
Page 197

**LED Color Options**



White



Warm White



Red



Blue



Green



RGB\*  
(programmable custom color)

\* Additional charges apply

**Lit Formed Colors:**



1838  
White

1800  
Yellow

1893  
Red

1862  
Red-Orange

1819  
Orange

1848  
Lt. Blue

1860  
Blue

1808  
Green

**Fabricated Face Colors:**



White

Ivory

Yellow

Red

Purple

Blue

Green

# Fabricated Stainless Steel - Face Lit

INCLUDES STANDARD MOUNTING, PATTERN & LED PACKAGE



## Stainless Steel Options



Brushed

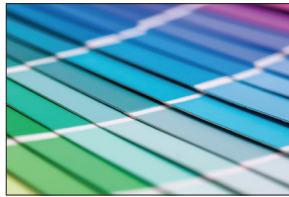

Painted

## Acrylic Insert Options



Available in 7 light diffused 3/16" acrylic colors

### LED Package Includes:

UL Listed with Sign Section labels, lead wires/cables and power supplies  
 Standard leads are 3-wire on metal letters & 2-wire on plastic letters;  
 10' long wire / cables.  
 Optional longer leads or individual wires available.  
 Systems are 12VDC, Class 2 power supplies.  
 Wiring diagrams and instructions are provided with LED lit sets.  
 UL label location - optional location, per customer request.  
 Appropriate mounting hardware and patterns for install  
 5 year warranty on Gemini electrical components



## PRICE PER LETTER INCLUDING LED PACKAGE

Pricing Notes - Page 133

SIZE	3" DEEP	4" DEEP	5" DEEP	6" DEEP
	BRUSHED OR PAINTED	BRUSHED OR PAINTED	BRUSHED OR PAINTED	BRUSHED OR PAINTED
9"	\$327	\$361		
10	345	382		
11	363	402		
12	385	425		
13	402	445	\$486	\$527
14	426	472	515	560
15	451	498	547	597
16	474	524	574	631
17	497	550	605	662
18	526	581	638	700
19	548	607	667	732
20	573	636	698	766
21	598	664	730	804
22	631	701	769	842
23	666	738	810	887
24	710	786	863	947
25	759	838	915	999
26	800	882	964	1,053
27	843	929	1,015	1,107
28	887	977	1,068	1,165
29	934	1,028	1,122	1,218
30*	980	1,077	1,172	1,274
31*	1,034	1,134	1,234	1,341
32*	1,090	1,195	1,297	1,405
33*	1,150	1,260	1,365	1,477
34*	1,212	1,327	1,437	1,554
35*	1,276	1,396	1,511	1,634
36*	1,344	1,469	1,589	1,717
37+	EMAIL FOR QUOTE			

LETTER HEIGHT - MAX DIMENSION

\*Oversize charges will apply

# Fabricated Aluminum - Face Lit

INCLUDES STANDARD MOUNTING, PATTERN & LED PACKAGE



## Aluminum Options

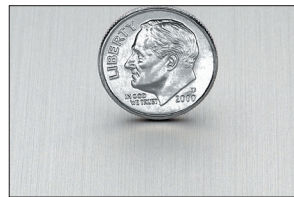

Brushed



Painted

**ADDITIONAL FINISH OPTIONS AVAILABLE**  
**Login to the Partner Portal**  
**for more details**

## Acrylic Insert Options



Available in 7 light diffused 3/16" acrylic colors

### Pricing Notes:

- Lower case letters are 90% of price listed
- Punctuation - small pieces; such as comma, period and dash are 33% of upper case price
- Bottom or top stud - email for quote
- Face / return painted separate +15%
- Standard lead is a 3-wire cable, 10' long
- Day / Night black vinyl available - email for quote
- Perforated returns available - email for quote
- NEW Block, Serif & Script priced the same



**PRICE PER LETTER**  
**INCLUDING LED PACKAGE**  
 SEE PAGE 132 FOR LED PACKAGE DETAILS

SIZE	3" DEEP BRUSHED OR PAINTED	4" DEEP BRUSHED OR PAINTED	5" DEEP BRUSHED OR PAINTED	6" DEEP BRUSHED OR PAINTED
< 16"	EMAIL FOR QUOTE			
16"	\$403	\$446	\$488	\$537
17	423	468	515	563
18	448	494	543	595
19	466	516	567	623
20	488	541	594	652
21	509	565	621	684
22	537	596	654	716
23	567	628	689	754
24	604	669	734	805
25	646	713	778	850
26	680	750	820	896
27	717	790	863	941
28	754	831	908	991
29	794	874	954	1,036
30*	833	916	997	1,083
31*	879	964	1,049	1,140
32*	927	1,016	1,103	1,195
33*	978	1,071	1,161	1,256
34*	1,031	1,128	1,222	1,321
35*	1,085	1,187	1,285	1,389
36*	1,143	1,249	1,351	1,460
37*	1,189	1,298	1,403	1,515
38*	1,237	1,348	1,457	1,572
39*	1,287	1,400	1,513	1,631
40*	1,339	1,454	1,571	1,693
41*	1,393	1,510	1,631	1,757
42*	1,449	1,569	1,693	1,823
43*	1,507	1,630	1,758	1,892
44*	1,568	1,693	1,825	1,963
45*	1,631	1,759	1,895	2,037
46*	1,697	1,827	1,968	2,114
48*	1,836	1,972	2,121	2,277
52*	2,150	2,295	2,464	2,640
56*	2,517	2,672	2,862	3,060
60*	2,946	3,109	3,324	3,548
61+	EMAIL FOR QUOTE			

LETTER HEIGHT - MAX DIMENSION

\*Oversize charges will apply



# Fabricated Stainless Steel Prepped for Face Lit - NO LEDs

**INCLUDES STANDARD MOUNTING & PATTERN**



## Stainless Steel Options



Brushed



Painted

## Acrylic Insert Options



Available in 7 light diffused 3/16" acrylic colors

### LED Package Includes:

UL Listed with Sign Section labels, lead wires/cables and power supplies  
Standard leads are 3-wire on metal letters & 2-wire on plastic letters;  
10' long wire / cables.

Optional longer leads or individual wires available.

Systems are 12VDC, Class 2 power supplies.

Wiring diagrams and instructions are provided with LED lit sets.

UL label location - optional location, per customer request.

Appropriate mounting hardware and patterns for install

5 year warranty on Gemini electrical components

SIZE	1" DEEP BRUSHED OR PAINTED	1.5" DEEP BRUSHED OR PAINTED	2" DEEP BRUSHED OR PAINTED	2.5" DEEP BRUSHED OR PAINTED	3" DEEP BRUSHED OR PAINTED	4" DEEP BRUSHED OR PAINTED	5" DEEP BRUSHED OR PAINTED	6" DEEP BRUSHED OR PAINTED
6"	\$167	\$178	\$189					
7	179	187	198					
8	187	196	207					
9	198	207	220	\$237	\$257	\$280		
10	211	220	233	249	272	296		
11	222	231	245	262	286	312		
12	235	244	260	278	301	329		
13	247	258	274	293	317	348	\$381	\$417
14	262	273	289	310	335	368	402	440
15	277	287	306	327	355	389	425	465
16	291	304	322	346	374	410	449	498
17	307	320	339	363	391	431	473	525
18	324	337	358	383	418	455	498	556
19	343	356	378	405	436	477	521	581
20	360	375	398	423	458	499	545	610
21	379	395	417	443	478	524	573	640
22	400	416	440	467	503	549	600	671
23	420	439	463	492	530	578	633	706
24	450	469	496	527	570	618	675	749
25	474	495	522	554	600	651	711	788
26	500	520	550	585	632	687	748	826
27	526	549	580	616	664	723	787	872
28	554	579	609	648	697	759	828	919
29	584	608	641	681	733	799	872	969
30*	615	640	675	718	777	841	904	1000
31*			712	757	818	886	952	1052
32*			751	798	860	932	1002	1107
33*			790	841	905	981	1055	1161
34*			831	885	952	1,020	1102	1209
35*			875	933	1,001	1,074	1158	1265
36*			936	994	1,052	1,131	1217	1324
37+	EMAIL FOR QUOTE							

LETTER HEIGHT - MAX DIMENSION

\*Oversize charges will apply

# Fabricated Aluminum - Face Lit Prepped for Face Lit - NO LEDs

INCLUDES STANDARD MOUNTING & PATTERN



## Aluminum Options



Brushed



Painted

**ADDITIONAL FINISH OPTIONS AVAILABLE**  
Login to the Partner Portal  
for more details

## Acrylic Insert Options



Available in 7 light diffused 3/16" acrylic colors

### Pricing Notes:

- Lower case letters are 90% of price listed
- Punctuation - small pieces; such as comma, period and dash are 33% of upper case price
- Bottom or top stud - email for quote
- Face / return painted separate +15%
- Standard lead is a 3-wire cable, 10' long
- Day / Night black vinyl available - email for quote
- Perforated returns available - email for quote
- NEW Block, Serif & Script priced the same

SIZE	3" DEEP BRUSHED OR PAINTED	4" DEEP BRUSHED OR PAINTED	5" DEEP BRUSHED OR PAINTED	6" DEEP BRUSHED OR PAINTED
< 16"	EMAIL FOR QUOTE			
16"	\$339	\$372	\$407	\$451
17	354	391	429	476
18	379	412	451	504
19	395	432	472	526
20	415	452	494	553
21	433	475	519	580
22	456	497	543	608
23	480	524	573	639
24	516	560	611	678
25	543	590	644	714
26	572	622	677	748
27	601	655	713	790
28	631	687	750	832
29	664	724	790	877
30*	704	762	819	905
31*	733	794	862	953
32*	764	827	907	1,002
33*	796	861	955	1,051
34*	829	897	998	1,095
35*	863	934	1,048	1,145
36*	899	973	1,102	1,199
37*	936	1,013	1,146	1,247
38*	975	1,055	1,192	1,297
39*	1,015	1,099	1,240	1,349
40*	1,057	1,145	1,289	1,403
41*	1,101	1,192	1,340	1,459
42*	1,147	1,241	1,393	1,517
43*	1,195	1,292	1,449	1,577
44*	1,244	1,345	1,507	1,640
45*	1,296	1,401	1,567	1,705
46*	1,350	1,459	1,629	1,773
48*	1,464	1,582	1,761	1,917
52*	1,722	1,860	2,059	2,240
56*	2,024	2,187	2,406	2,617
60*	2,378	2,571	2,811	3,058
61+	EMAIL FOR QUOTE			

LETTER HEIGHT - MAX DIMENSION

\*Oversize charges will apply



**PRICE PER LETTER INCLUDING LED PACKAGE**

**Trimless Fabricated Stainless Steel - Face Lit**  
**INCLUDES STANDARD MOUNTING, PATTERN & LED PACKAGE**

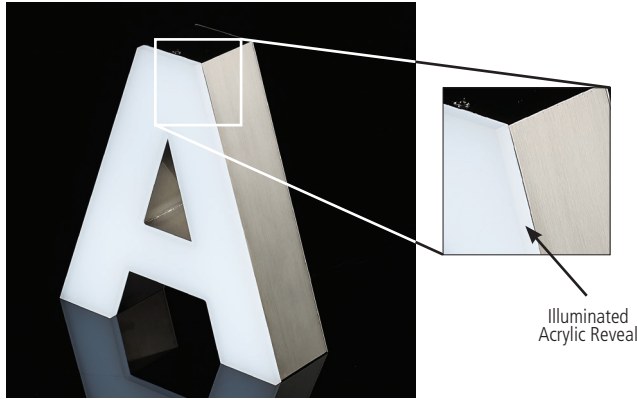

Illuminated Acrylic Reveal

**Stainless Steel Options**

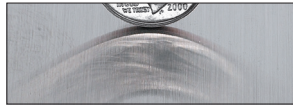

Brushed



Painted

**ADDITIONAL FINISH OPTIONS AVAILABLE**  
**Login to the Partner Portal**  
**for more details**

**LED Options**



(programmable custom color)

\* Additional charges apply

**BRUSHED OR PAINTED**

SIZE	2" DEEP			3" DEEP		
	ACRYLIC REVEAL			ACRYLIC REVEAL		
	1/4"	1/2"	3/4"	1/4"	1/2"	3/4"
6"	\$330	\$344	\$363			
7"	348	363	382			
8"	364	380	400			
9"	386	403	424	\$427	\$446	\$470
10"	408	426	448	452	472	497
11"	428	446	470	475	496	522
12"	454	474	499	502	524	552
13"	477	498	524	528	551	581
14"	504	526	554	557	581	613
15"	532	555	585	589	615	648
16"	560	584	615	620	647	682
17"	587	612	645	650	678	715
18"	621	648	683	687	717	755
19"	650	678	714	719	750	791
20"	683	712	751	755	788	830
21"	716	747	787	792	827	871
22"	755	788	830	834	871	917
23"	794	828	873	874	912	961
24"	846	882	930	930	971	1,023
25"	889	927	977	976	1,019	1,073
26"	935	975	1,028	1,026	1,071	1,128
27"	985	1,027	1,083	1,080	1,127	1,188
28"	1,035	1,080	1,138	1,135	1,185	1,248
29"	1,088	1,135	1,196	1,193	1,245	1,312
30"*	1,143	1,192	1,256	1,251	1,306	1,376
31"*	1,206	1,258	1,326	1,321	1,379	1,453
32"*	1,268	1,323	1,394	1,384	1,445	1,522
33"*	1,334	1,391	1,466	1,460	1,524	1,606
34"*	1,401	1,461	1,540	1,532	1,599	1,685
35"*	1,474	1,538	1,620	1,609	1,679	1,769
36"*	1,555	1,622	1,709	1,692	1,766	1,861
37"+	EMAIL FOR QUOTE					

LETTER HEIGHT - MAX DIMENSION

**Mini-Trimless Stainless Steel**  
**PRICE PER LETTER**

\*Oversize charges will apply

	1.5" DEEP			2" DEEP			2-1/2" DEEP			3" DEEP		
	ACRYLIC REVEAL			ACRYLIC REVEAL			ACRYLIC REVEAL			ACRYLIC REVEAL		
	1/4"	1/2"	3/4"	1/4"	1/2"	3/4"	1/4"	1/2"	3/4"	1/4"	1/2"	3/4"
3"	\$290	\$303	\$315	\$297	\$310	\$323						
4	306	320	333	311	325	338						
5	321	335	349	328	343	357						
6	337	352	366	344	359	374						
7	354	370	385	361	377	393						
8	372	389	404	380	397	413	\$395	\$413	\$429	\$423	\$442	\$461
9	390	407	424	398	416	433	415	434	451	444	464	483
10	410	428	446	418	437	455	436	455	474	467	488	508
11	431	450	468	440	460	479	458	478	498	490	512	533
12	452	472	491	462	483	502	480	501	522	515	538	561
13	EMAIL FOR QUOTE											

**Mini-Trimless Pricing Notes**

- 3" - Upper case only
- Lower case letters are 90% of price listed
- Punctuation - small pieces; such as comma, period and dash are 33% of upper case price
- Flush screws on returns
- Premium LEDs designed for small letters
- Narrow strokes available - down to 0.65"
- Larger sizes available - Email for quote



# Trimless Fabricated Aluminum - Face Lit

INCLUDES STANDARD MOUNTING, PATTERN & LED PACKAGE

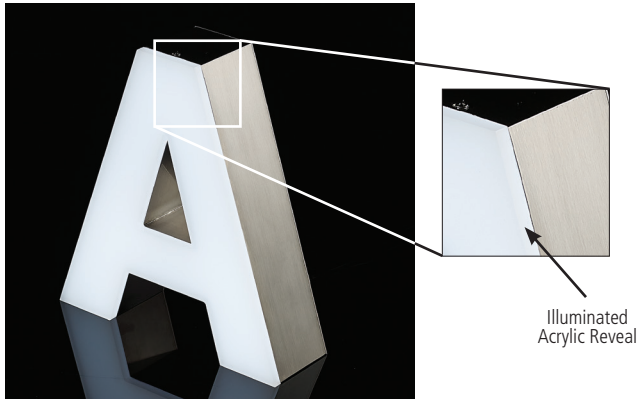

## Aluminum Options

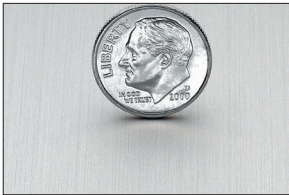

Brushed



Painted

**ADDITIONAL FINISH OPTIONS AVAILABLE**  
**Login to the Partner Portal**  
**for more details**

## LED Options



White



Red



Green



Blue



RGB\*

(programmable custom color)

\* Additional charges apply

### LED Package Includes:

UL Listed with Sign Section labels, lead wires/cables and power supplies  
 Standard leads are 3-wire on metal letters & 2-wire on plastic letters;  
 10' long wire / cables.  
 Optional longer leads or individual wires available.  
 Systems are 12VDC, Class 2 power supplies.  
 Wiring diagrams and instructions are provided with LED lit sets.  
 UL label location - optional location, per customer request.  
 Appropriate mounting hardware and patterns for install  
 5 year warranty on Gemini electrical components



## PRICE PER LETTER INCLUDING LED PACKAGE

### BRUSHED OR PAINTED

SIZE	2" DEEP			3" DEEP		
	ACRYLIC REVEAL			ACRYLIC REVEAL		
	1/4"	1/2"	3/4"	1/4"	1/2"	3/4"
16"	\$537	\$568	\$614	\$594	\$628	\$679
17"	563	595	644	623	659	712
18"	595	629	681	659	697	753
19"	623	659	713	689	728	787
20"	655	692	749	724	765	827
21"	686	725	785	759	802	867
22"	724	765	828	799	845	913
23"	761	805	871	838	886	958
24"	811	857	928	891	942	1,018
25"	852	901	975	936	989	1,070
26"	896	947	1,025	983	1,039	1,123
27"	944	998	1,080	1,035	1,094	1,183
28"	992	1,049	1,135	1,088	1,150	1,243
29"	1,043	1,103	1,193	1,143	1,208	1,306
30**	1,095	1,158	1,253	1,199	1,267	1,370
31**	1,156	1,222	1,323	1,266	1,338	1,447
32**	1,215	1,284	1,390	1,326	1,402	1,515
33**	1,278	1,351	1,462	1,399	1,479	1,599
34**	1,343	1,420	1,537	1,468	1,552	1,678
35**	1,413	1,494	1,617	1,542	1,630	1,762
36**	1,490	1,575	1,705	1,621	1,713	1,853
37"+	EMAIL FOR QUOTE					

LETTER HEIGHT - MAX DIMENSION

\*Oversize charges will apply

### Pricing Notes:

- Lower case letters are 90% of price listed
- Punctuation - small pieces; such as comma, period and dash are 33% of upper case price
- Standard lead is a 3-wire cable, 10' long
- NEW Block, Serif & Script priced the same

# Lit Acrylic - Face Lit L-100

INCLUDES STANDARD MOUNTING, PATTERN & LED PACKAGE



## Acrylic Return Options



Painted

## LED Color Options



White

Warm  
White

Red



Blue

Green



## PRICE PER LETTER INCLUDING LED PACKAGE

### PAINTED RETURNS

		1-1/2" DEEP
		PRICE
Upper Case Only	8"	\$316
	9	338
	10	361
LETTER HEIGHT - MAX DIMENSION	11	379
	12	408
	13	450
	14	486
	15	521
	16	544
	17	588
	18	611
	19	713
	20	763
	21	798
	22	834
	23	868
	24	904
	25+	EMAIL FOR QUOTE

### Pricing Notes:

- Lower case letters are 90% of price listed
- Punctuation - small pieces; such as comma, period and dash are 33% of upper case price
- Bottom or Top Stud email for quote
- Standard lead is a 2-wire cable, 10' long
- Studs included

### LED Package Includes:

UL Listed with Sign Section labels, lead wires/cables and power supplies  
Standard leads are 3-wire on metal letters & 2-wire on plastic letters;  
10' long wire / cables.

Optional longer leads or individual wires available.

Systems are 12VDC, Class 2 power supplies.

Wiring diagrams and instructions are provided with LED lit sets.

UL label location - optional location, per customer request.

Appropriate mounting hardware and patterns for install

5 year warranty on Gemini electrical components

# Lit Acrylic - Translucent Vinyl - Face Lit L-700

INCLUDES STANDARD MOUNTING, PATTERN & LED PACKAGE











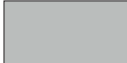

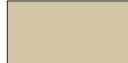
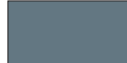

## Acrylic Return Options



Painted

## Translucent Vinyl Face Colors

				
Gold Metallic 3630-131	Silver 3630-121	White 3630-20	Ivory 3630-005	Slate Grey 3630-61
				
Orange 3630-44	Lt. Tomato Red 3630-43	Red 3630-33	Intense Blue 3630-127	European Blue 3630-137
				
Plum Purple 3630-128	Burgundy 3630-49	Holly Green 3630-76	Yellow 3630-015	Golden Yellow 3630-125

### LED Package Includes:

UL Listed with Sign Section labels, lead wires/cables and power supplies  
Standard leads are 3-wire on metal letters & 2-wire on plastic letters;  
10' long wire / cables.

Optional longer leads or individual wires available.

Systems are 12VDC, Class 2 power supplies.

Wiring diagrams and instructions are provided with LED lit sets.

UL label location - optional location, per customer request.

Appropriate mounting hardware and patterns for install

5 year warranty on Gemini electrical components



## PRICE PER LETTER INCLUDING LED PACKAGE

		PAINTED RETURNS	
		1-1/2" DEEP	
		SIZE	PRICE
Upper Case Only		8"	\$376
		9	403
		10	428
LETTER HEIGHT - MAX DIMENSION		11	451
		12	485
		13	536
		14	579
		15	621
		16	649
		17	703
		18	730
		19	851
		20	913
		21	954
		22	996
	23	1,037	
	24	1,080	
	25+	EMAIL FOR QUOTE	

### Pricing Notes:

- Lower case letters are 90% of price listed
- Punctuation - small pieces; such as comma, period and dash are 33% of upper case price
- Bottom or Top Stud email for quote
- Standard lead is a 2-wire cable, 10' long
- Studs included



# Lit Formed (GemLite) - Face Lit G-300

INCLUDES STANDARD MOUNTING, PATTERN & LED PACKAGE



Flat return with no visible can

Stepped return with visible can



## Lit Formed Return Options



Painted

## Face Color Options



1838 - White

1800 - Yellow

1893 - Red

1862 - Red-Orange



1819 - Orange

1848 - Light Blue

1860 - Blue

1808 - Light Green



## PRICE PER LETTER INCLUDING LED PACKAGE

SEE PAGE 137 FOR LED PACKAGE DETAILS

### PAINTED RETURNS

SIZE	APPROX. DEPTH	FLAT RETURN	STEPPED RETURN
6"	1"	\$152	--
7	1	152	--
8	1 1/4	152	--
9	1 1/4	152	\$105
10	1 1/4	172	119
11	1 1/4	188	130
12	1 1/2	194	134
13	1 1/2	207	143
14	1 1/2	222	154
15	1 1/2	240	166
16	1 1/2	266	184
17	1 1/2	292	202
18	2	314	217
19	2	350	242
20	2	382	265
21	2	414	287
22	2	453	314
23	2	486	337
24	2	533	370
25	2	576	400
26	2	620	430
27	2	663	460
28	2	761	528
30*	2	848	588
32*	2	956	664
34*	2	1,040	722
36*	2	1,109	785
37+	EMAIL FOR QUOTE		

LETTER HEIGHT - MAX DIMENSION

\*Oversize charges will apply

### Pricing Notes:

- Lower case letters are 90% of price listed
- Punctuation - small pieces; such as comma, period and dash are 33% of upper case price
- Includes stud mounts with stand-offs
- Face / return painted separate +15%
- Standard lead is a 2-wire cable, 10' long
- Round or prismatic face add 15%









## **ILLUMINATE DIFFERENTLY**

New and unique lighting solutions are being created at Gemini every day. Our industry-leading manufacturing and materials fabrication capabilities combine with the rapid advancement of the latest high efficiency, solid-state compact LED technologies to introduce innovations and lighting effects that were unheard of just a few years ago.

**1.800-538-8377**





# SPECIALTY ILLUMINATED

Illuminated letters and logos from 6" to 45"

Narrow strokes, low profiles and tight curves

5 standard LED colors plus multi-color RGB

Compact, integrated LED lighting modules

Industry-leading lead times

## BRIGHT IDEAS START HERE











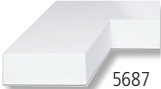

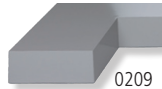

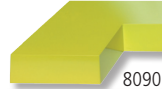









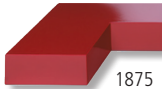





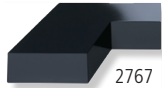



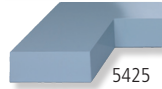

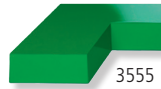
When it comes to lighting innovation, consider Gemini more illuminated than others. As a leading fabrication partner to some of the world's top designers and sign builders, we're always pushing the boundaries of what's possible. We have the ability and the technologies to bring your most brilliant concepts to life, providing fully-integrated, UL-approved solutions offering flawless illumination and extremely low maintenance, in the most unique forms and materials.

### WHEN ORDERING

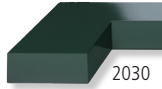
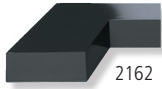
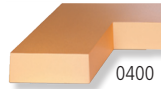
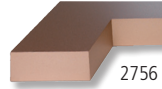
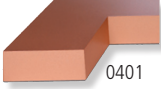
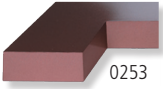
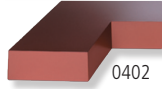
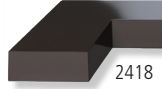
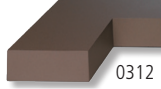
PLEASE SPECIFY:

- Product Type
- LED Color
- Size (Height) & Thickness
- Color Selection
- Vector Art or Standard Font
- Install Method

## Standard Painted Colors:

 5687 White Approx PMS White	 2718 Ivory Approx PMS 7499	 4660 Desert Sand Approx PMS 7506	 0209 Grey Approx PMS 423	 4310 Dove Grey Approx PMS 431	 8090 Safety Green Approx PMS 809
 2037 Lemon Yellow Approx PMS 102	 2000 Yellow Approx PMS 108	 0217 Citrus Yellow Approx PMS 606	 0218 Sundance Yellow Approx PMS 116	 0254 Mango Approx PMS 137	 2119 Orange Approx PMS 021
 2662 Red-Orange Approx PMS 485	 0256 Rampart Orange Approx PMS 172	 2793 Red Approx PMS 185	 1875 Brick Red Approx PMS 7623	 2280 Black Cherry Approx PMS 1817	 2240 Maroon Approx PMS 202
 2410 Magenta Approx PMS 241	 2287 Purple Approx PMS 2695	 0246 Violet Toner Approx PMS 2725	 2767 Midnight Blue Approx PMS 5395	 2050 Dark Blue Approx PMS 281	 2860 Medium Blue Approx PMS 286
 3000 Blue Approx PMS 300	 2648 Light Blue Approx PMS 2995	 5425 Marine Reef Blue Approx PMS 5425	 3210 Teal Blue Approx PMS 321	 3555 Spring Green Approx PMS 355	 0222 Emerald Green Approx PMS 356
 0259 Federal Green Approx PMS 350	 2108 Light Green Approx PMS 3415	 2030 Dark Green Approx PMS 3435	 2162 Hunter Green Approx PMS 3308	 0400 Brilliant Gold Approx PMS 7556	 2756 Metallic Gold* Approx PMS 465
 0401 Aztec Gold Approx PMS 2317	 0253 Copper Approx PMS 7600	 0402 Aztec Copper Approx PMS 7599	 2418 Brown Approx PMS 476	 0312 Medium Bronze* Approx PMS 2335	 0314 Old Copper* Approx PMS 2334
 3130 Duranodic Bronze* Approx PMS 2336	 1315 Dark Oxide Approx PMS 447	 8886 Metallic Silver* Approx PMS 420	 2025 Black Approx PMS Black		



## Custom Paint Color:

It's easy to request custom color matching! Simply tell us the paint number or name and brand of paint you'd like us to match (e.g. PMS 186 or Sherwin-Williams Boathouse Blue) and we will obtain a mixing formula at no cost to you.

Don't have a paint name or number and still need a color exactly matched? Please send us a sample (sample item must be at least 3" x 3") and our paint lab will run it through an exacting color match process. Exact color matching from a sample is \$200.

**Standard Face Finishes:**

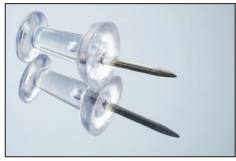

901  
Polished Aluminum



902  
Brushed Aluminum

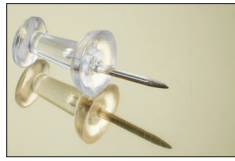

903  
Polished Brass



904  
Brushed Light Brass

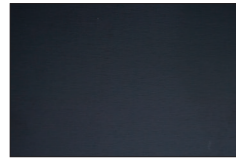

908  
Satin Black



909  
Satin Silver



915  
Brushed Brass



916  
Brushed Pewter



917  
Brushed Black



925  
Brushed Med. Bronze



927  
Light Stainless



906  
Brushed Copper Aluminum



910  
Satin Gold Aluminum



924  
Bronze Stainless Aluminum



3102  
Rancho Walnut Veneer



912  
Satin Bronze Aluminum

*Special Order Finishes Also Available.  
Email for Quote.*

**CHEMETAL • treefrog • InteriorArts  
or Your Specified Manufacturer**

**Lit Formed Colors:**



**Translucent Vinyl Face Colors (3M Scotchcal™ Translucent Graphic Film Series 3630)**





# Lit Acrylic - Face & Halo Lit L-200

INCLUDES STANDARD MOUNTING, PATTERN & LED PACKAGE



## Acrylic Return Options



Painted

## LED Color Options



White

Warm  
White

Red



Blue

Green



## PRICE PER LETTER INCLUDING LED PACKAGE

### PAINTED RETURNS

		1-1/2" DEEP
		PRICE
Upper Case Only	8"	\$316
	9	338
	10	361
LETTER HEIGHT - MAX DIMENSION	11	379
	12	408
	13	450
	14	486
	15	521
	16	544
	17	588
	18	611
	19	713
	20	763
	21	798
	22	834
23	868	
24	904	
25+	EMAIL FOR QUOTE	

### Pricing Notes:

- Lower case letters are 90% of price listed
- Punctuation - small pieces; such as comma, period and dash are 33% of upper case price
- Bottom or Top Stud email for quote
- Standard lead is a 2-wire cable, 10' long
- Detachable studs included

### LED Package Includes:

UL Listed with Sign Section labels, lead wires/cables and power supplies  
Standard leads are 3-wire on metal letters & 2-wire on plastic letters;  
10' long wire / cables.

Optional longer leads or individual wires available.

Systems are 12VDC, Class 2 power supplies.

Wiring diagrams and instructions are provided with LED lit sets.

UL label location - optional location, per customer request.

Appropriate mounting hardware and patterns for install

5 year warranty on Gemini electrical components

# Lit Acrylic - Face & Side Lit L-300

INCLUDES STANDARD MOUNTING, PATTERN & LED PACKAGE



## LED Color Options



White

Warm White

Red



Blue

Green



## PRICE PER LETTER INCLUDING LED PACKAGE

		TRANSLUCENT RETURNS	
		1-1/2" DEEP	
		SIZE	PRICE
Upper Case Only		8"	\$286
		9	309
		10	328
LETTER HEIGHT - MAX DIMENSION		11	344
		12	370
		13	408
		14	442
		15	472
		16	494
		17	535
		18	556
		19	648
		20	694
		21	724
		22	756
	23	787	
	24	821	
	25+	EMAIL FOR QUOTE	

### Pricing Notes:

- Lower case letters are 90% of price listed
- Punctuation - small pieces; such as comma, period and dash are 33% of upper case price
- Bottom or Top Stud email for quote
- Standard lead is a 2-wire cable, 10' long
- Studs included

### LED Package Includes:

UL Listed with Sign Section labels, lead wires/cables and power supplies  
Standard leads are 3-wire on metal letters & 2-wire on plastic letters;  
10' long wire / cables.

Optional longer leads or individual wires available.

Systems are 12VDC, Class 2 power supplies.

Wiring diagrams and instructions are provided with LED lit sets.

UL label location - optional location, per customer request.

Appropriate mounting hardware and patterns for install

5 year warranty on Gemini electrical components

# Lit Acrylic - Metal Face / Side Lit L-400

INCLUDES STANDARD MOUNTING, PATTERN & LED PACKAGE



## Metal Face Options



901  
Polished Aluminum



902  
Brushed Aluminum



903  
Polished Brass



904  
Brushed Light Brass

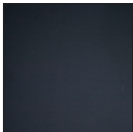

908  
Satin Black



909  
Satin Silver



915  
Brushed Brass



916  
Brushed Pewter

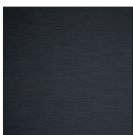

917  
Brushed Black

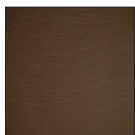

925  
Brushed Med. Bronze



927  
Light Stainless

## LED Color Options



White

Warm  
White

Red



Blue

Green



**PRICE PER LETTER  
INCLUDING LED PACKAGE**

**INTERIOR  
ONLY!**

**METAL FACE  
1-1/2" DEEP**

	SIZE	PRICE	
Upper Case Only	8"	\$331	
	9	356	
	10	378	
	11	397	
	12	428	
	13	474	
	14	511	
	15	548	
	16	571	
	17	618	
	18	643	
	19	750	
	20	803	
	21	840	
	22	877	
	23	913	
	24	950	
	25+	EMAIL FOR QUOTE	

### Pricing Notes:

- Lower case letters are 90% of price listed
- Punctuation - small pieces; such as comma, period and dash are 33% of upper case price
- Bottom or Top Stud email for quote
- Standard lead is a 2-wire cable, 10' long
- Studs included

### LED Package Includes:

UL Listed with Sign Section labels, lead wires/cables and power supplies  
Standard leads are 3-wire on metal letters & 2-wire on plastic letters;  
10' long wire / cables.

Optional longer leads or individual wires available.

Systems are 12VDC, Class 2 power supplies.

Wiring diagrams and instructions are provided with LED lit sets.

UL label location - optional location, per customer request.

Appropriate mounting hardware and patterns for install

5 year warranty on Gemini electrical components



# Lit Acrylic - Side Lit L-500

INCLUDES STANDARD MOUNTING, PATTERN & LED PACKAGE



## Acrylic Face Options



Painted

## LED Color Options



White

Warm  
White

Red



Blue

Green



## PRICE PER LETTER INCLUDING LED PACKAGE

		PAINTED FACE
		1-1/2" DEEP
	SIZE	PRICE
Upper Case Only	8"	\$319
	9	343
	10	365
	11	384
LETTER HEIGHT - MAX DIMENSION	12	412
	13	457
	14	492
	15	528
	16	551
	17	597
	18	621
	19	723
	20	775
	21	810
	22	844
	23	880
	24	916
25+	EMAIL FOR QUOTE	

### Pricing Notes:

- Lower case letters are 90% of price listed
- Punctuation - small pieces; such as comma, period and dash are 33% of upper case price
- Bottom or Top Stud email for quote
- Standard lead is a 2-wire cable, 10' long
- Studs included

### LED Package Includes:

UL Listed with Sign Section Labels, lead wires/cables and power supplies  
Standard leads are 3-wire on metal letters & 2-wire on plastic letters;  
10' long wire / cables.

Optional longer leads or individual wires available.

Systems are 12VDC, Class 2 power supplies.

Wiring diagrams and instructions are provided with LED lit sets.

UL label location - optional location, per customer request.

Appropriate mounting hardware and patterns for install

5 year warranty on Gemini electrical components

# Lit Acrylic - Vinyl Face / Side Lit L-600

INCLUDES STANDARD MOUNTING, PATTERN & LED PACKAGE



## Translucent Vinyl Face Colors

(3M Scotchcal™ Translucent Graphic Film Series 3630)

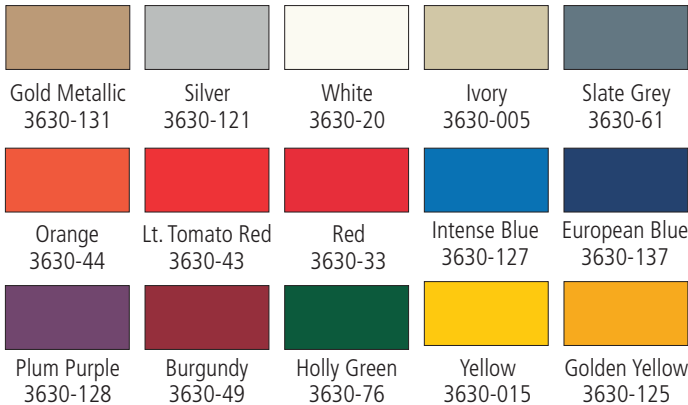

## LED Color Options



White

Warm  
White

Red



Blue

Green



## PRICE PER LETTER INCLUDING LED PACKAGE

		VINYL FACE 1-1/2" DEEP
		PRICE
Upper Case Only	8"	\$319
	9	343
	10	365
	11	384
	12	412
	13	457
	14	492
	15	528
	16	551
	17	597
	18	621
	19	723
	20	775
	21	810
	22	844
	23	880
	24	916
	25+	EMAIL FOR QUOTE

### Pricing Notes:

- Lower case letters are 90% of price listed
- Punctuation - small pieces; such as comma, period and dash are 33% of upper case price
- Bottom or Top Stud email for quote
- Standard lead is a 2-wire cable, 10' long
- Studs included

### LED Package Includes:

UL Listed with Sign Section labels, lead wires/cables and power supplies  
Standard leads are 3-wire on metal letters & 2-wire on plastic letters;  
10' long wire / cables.

Optional longer leads or individual wires available.

Systems are 12VDC, Class 2 power supplies.

Wiring diagrams and instructions are provided with LED lit sets.

UL label location - optional location, per customer request.

Appropriate mounting hardware and patterns for install

5 year warranty on Gemini electrical components

# Lit Acrylic - Face & Halo Lit L-800

INCLUDES STANDARD MOUNTING, PATTERN & LED PACKAGE



## Acrylic Return Options



Painted

## Translucent Vinyl Face Colors

(3M Scotchcal™ Translucent Graphic Film Series 3630)

Gold Metallic 3630-131	Silver 3630-121	White 3630-20	Ivory 3630-005	Slate Grey 3630-61
Orange 3630-44	Lt. Tomato Red 3630-43	Red 3630-33	Intense Blue 3630-127	European Blue 3630-137
Plum Purple 3630-128	Burgundy 3630-49	Holly Green 3630-76	Yellow 3630-015	Golden Yellow 3630-125



## PRICE PER LETTER INCLUDING LED PACKAGE

		VINYL FACE 1-1/2" DEEP
		PRICE
Upper Case Only	8"	\$376
	9	403
	10	428
LETTER HEIGHT - MAX DIMENSION	11	451
	12	485
	13	536
	14	579
	15	621
	16	649
	17	703
	18	730
	19	851
	20	913
	21	954
	22	996
	23	1,037
	24	1,080
	25+	EMAIL FOR QUOTE

### Pricing Notes:

- Lower case letters are 90% of price listed
- Punctuation - small pieces; such as comma, period and dash are 33% of upper case price
- Bottom or Top Stud email for quote
- Standard lead is a 2-wire cable, 10' long
- Studs included

### LED Package Includes:

UL Listed with Sign Section Labels, lead wires/cables and power supplies  
Standard leads are 3-wire on metal letters & 2-wire on plastic letters;  
10' long wire / cables.  
Optional longer leads or individual wires available.  
Systems are 12VDC, Class 2 power supplies.  
Wiring diagrams and instructions are provided with LED lit sets.  
UL label location - optional location, per customer request.  
Appropriate mounting hardware and patterns for install  
5 year warranty on Gemini electrical components



# Formed Plastic (GemLite) - Face & Side Lit G-100

INCLUDES STANDARD MOUNTING, PATTERN & LED PACKAGE



Flat return with no visible can



Stepped return with visible can



## Lit Formed Color Options



1838 - White



1800 - Yellow



1893 - Red



1862 - Red-Orange



1819 - Orange



1848 - Light Blue



1860 - Blue



1808 - Light Green



## PRICE PER LETTER INCLUDING LED PACKAGE TRANSLUCENT FACE & RETURNS

SIZE	APPROX. DEPTH	FLAT RETURN	STEPPED RETURN
6"	1"	\$126	--
7	1	126	--
8	1 1/4	126	--
9	1 1/4	126	\$105
10	1 1/4	143	119
11	1 1/4	156	130
12	1 1/2	161	134
13	1 1/2	172	143
14	1 1/2	185	154
15	1 1/2	200	166
16	1 1/2	221	184
17	1 1/2	243	202
18	2	261	217
19	2	291	242
20	2	318	265
21	2	345	287
22	2	377	314
23	2	405	337
24	2	444	370
25	2	480	400
26	2	516	430
27	2	552	460
28	2	634	528
30	2	706	588
32	2	797	664
34	2	867	722
36	2	924	785
37"+	EMAIL FOR QUOTE		

LETTER HEIGHT - MAX DIMENSION

\*Oversize charges will apply

### LED Package Includes:

UL Listed with Sign Section labels, lead wires/cables and power supplies  
 Standard leads are 3-wire on metal letters & 2-wire on plastic letters;  
 10' long wire / cables.  
 Optional longer leads or individual wires available.  
 Systems are 12VDC, Class 2 power supplies.  
 Wiring diagrams and instructions are provided with LED lit sets.  
 UL label location - optional location, per customer request.  
 Appropriate mounting hardware and patterns for install  
 5 year warranty on Gemini electrical components

### Pricing Notes:

- Lower case letters are 90% of price listed
- Punctuation - small pieces; such as comma, period and dash are 33% of upper case price
- Includes stud mounts
- Standard lead is a 2-wire cable, 10' long
- Round or prismatic face add 15%

# Formed Plastic (GemLite) - Side Lit G-400

INCLUDES STANDARD MOUNTING, PATTERN & LED PACKAGE



## PRICE PER LETTER INCLUDING LED PACKAGE PAINTED FACE



### Lit Formed Face Options



Painted

### Lit Formed Color Options



1838 - White

1800 - Yellow

1893 - Red

1862 - Red-Orange



1819 - Orange

1848 - Light Blue

1860 - Blue

1808 - Light Green

#### LED Package Includes:

UL Listed with Sign Section labels, lead wires/cables and power supplies  
Standard leads are 3-wire on metal letters & 2-wire on plastic letters;  
10' long wire / cables.  
Optional longer leads or individual wires available.  
Systems are 12VDC, Class 2 power supplies.  
Wiring diagrams and instructions are provided with LED lit sets.  
UL label location - optional location, per customer request.  
Appropriate mounting hardware and patterns for install  
5 year warranty on Gemini electrical components

SIZE	APPROX. DEPTH	PRICE
6"	1"	\$152
7	1	152
8	1 1/4	152
9	1 1/4	152
10	1 1/4	172
11	1 1/4	188
12	1 1/2	194
13	1 1/2	207
14	1 1/2	222
15	1 1/2	240
16	1 1/2	266
17	1 1/2	292
18	2	314
19	2	350
20	2	382
21	2	414
22	2	453
23	2	486
24	2	533
25	2	576
26	2	620
27	2	663
28	2	761
30	2	848
32	2	956
34	2	1,040
36	2	1,109
25+	EMAIL FOR QUOTE	

LETTER HEIGHT - MAX DIMENSION

#### Pricing Notes:

- Lower case letters are 90% of price listed
- Punctuation - small pieces; such as comma, period and dash are 33% of upper case price
- Includes stud mounts with stand-offs
- Standard lead is a 2-wire cable, 10' long
- Round or prismatic face add 15%

# Faux Neon - Face & Side Lit G-500

INCLUDES STANDARD MOUNTING, PATTERN & LED PACKAGE



## Faux Neon Color Options



1838 - White

1800 - Yellow

1893 - Red

1862 - Red-Orange



1819 - Orange

1848 - Light Blue

1860 - Blue

1808 - Light Green

### LED Package Includes:

UL Listed with Sign Section labels, lead wires/cables and power supplies  
Standard leads are 3-wire on metal letters & 2-wire on plastic letters;  
10' long wire / cables.

Optional longer leads or individual wires available.

Systems are 12VDC, Class 2 power supplies.

Wiring diagrams and instructions are provided with LED lit sets.

UL label location - optional location, per customer request.

Appropriate mounting hardware and patterns for install

5 year warranty on Gemini electrical components



## PRICE PER LETTER INCLUDING LED PACKAGE TRANSLUCENT FACE & RETURNS

SIZE	APPROX. DEPTH	PRICE
6"	1"	\$152
7	1	152
8	1 1/4	152
9	1 1/4	152
10	1 1/4	172
11	1 1/4	188
12	1 1/2	194
13	1 1/2	207
14	1 1/2	222
15	1 1/2	240
16	1 1/2	266
17	1 1/2	292
18	2	314
19	2	350
20	2	382
21	2	414
22	2	453
23	2	486
24	2	533
25+	EMAIL FOR QUOTE	

LETTER HEIGHT - MAX DIMENSION

### Pricing Notes:

- Lower case letters are 90% of price listed
- Punctuation - small pieces; such as comma, period and dash are 33% of upper case price
- Includes stud mounts with stand-offs
- Standard lead is a 2-wire cable, 10' long
- Round or prismatic face add 15%



CUSTOM LOGOS AVAILABLE - EMAIL FOR QUOTE







# Village Creek

## ENHANCE YOUR OFFERING

Expand your signage portfolio and capture additional projects by partnering with Gemini, one of the industry's leading resource for architectural, wayfinding and commemorative plaques made-to-order in a variety of forms and appearance solutions.





## CLASSIC TO CONTEMPORARY

Gemini is your premier resource to meet the growing demand for made-to-order precision tooled, cast, etched plaques and thin gauge plates. Sign makers, architects, monument builders and designers rely on Gemini's in-house, environmentally-friendly foundries to create impressive architectural signage, wayfinding solutions, commemorative and memorial monuments, and plates that provide engaging signage that last for decades.



## PRECISION TOOLED PLAQUES

Minimum Height/Width	Maximum Height/Width	Maximum Size*	Depth/Thickness	Application	Material
2"	84"	24 sq ft / 3,456 sq in (eg 40" x 84")	1/8", 1/4" and 5/16"	Indoor or Outdoor Use	Aluminum, Bronze & Brass

\*Depends on material and thickness



## CAST PLAQUES

Minimum Height/Width	Maximum Height/Width	Maximum Size*	Depth/Thickness	Application	Material
2"	96"	40 sq ft / 5,760 sq in (eg 60" x 96")	5/16", 1/2", 3/4" and 1"	Indoor or Outdoor Use	Aluminum & Bronze

\*Depends on material and thickness



## ETCHED PLAQUES

Minimum Height/Width	Maximum Height/Width	Maximum Size*	Depth/Thickness	Application	Material
2"	72"	18 sq ft / 2,592 sq in (eg 36" x 72")	1/16", 1/8" and 1/4"	Indoor or Outdoor Use	Stainless Steel, Bronze, Brass & Aluminum

\*Depends on material and thickness

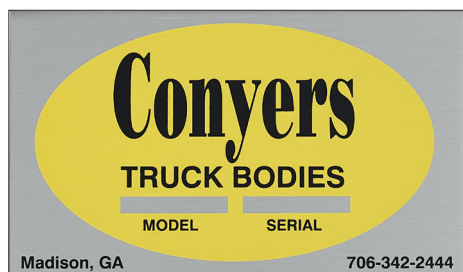

## THIN GAUGE PLAQUES

Minimum Height/Width	Maximum Height/Width	Maximum Size*	Depth/Thickness	Application	Material
1"	36"	5.75 sq ft / 828 sq in (eg 23" x 36")	.020", .025", .029", .040" & .050"	Indoor & Some Outdoor Use	Stainless Steel, Aluminum & Brass

\*Depends on material and thickness





## PLAQUES THAT ARE A CUT ABOVE

Precision tooled plaques with unique profiles and mounting options can be easily and permanently affixed to monument signs, or mounted to become the sign itself. Gemini offers advanced machining and finishing capabilities to realize any plaque design ambition in just days.





# PRECISION TOOLED PLAQUES

Exquisite detail in a raised-single level surface

Lead-free aluminum, bronze or brass alloys

Numerous textures, colors and finishes

Any size up to 40" x 64" in any fractional dimension

Industry-leading lead times

## PRECISION AND PERMANANCE

With Gemini's precision plaque tooling capabilities, even the most articulated logos and small lettering can be captured in crisp detail. Choose versatile, lighter weight aluminum or the distinctive looks of bronze or brass, all in earth-friendly, lead- and mercury-free alloys, to produce lasting communication designed to endure the toughest environmental conditions for decades. And there's no upcharge for distinctive borders and braille. With Gemini, these impressive artifacts are more affordable, faster and easier to produce than you think.

### WHEN ORDERING

PLEASE SPECIFY:

- Artwork & Critical Dimensions
- Material Selection
- Border Style
- Background Color & Texture
- Finish Selection
- Mounting Method

## Standard Borders

Border finish matches plaque copy. Other borders are also available. Email for a quote. (Illustrations not to scale) Edge color matches background color.

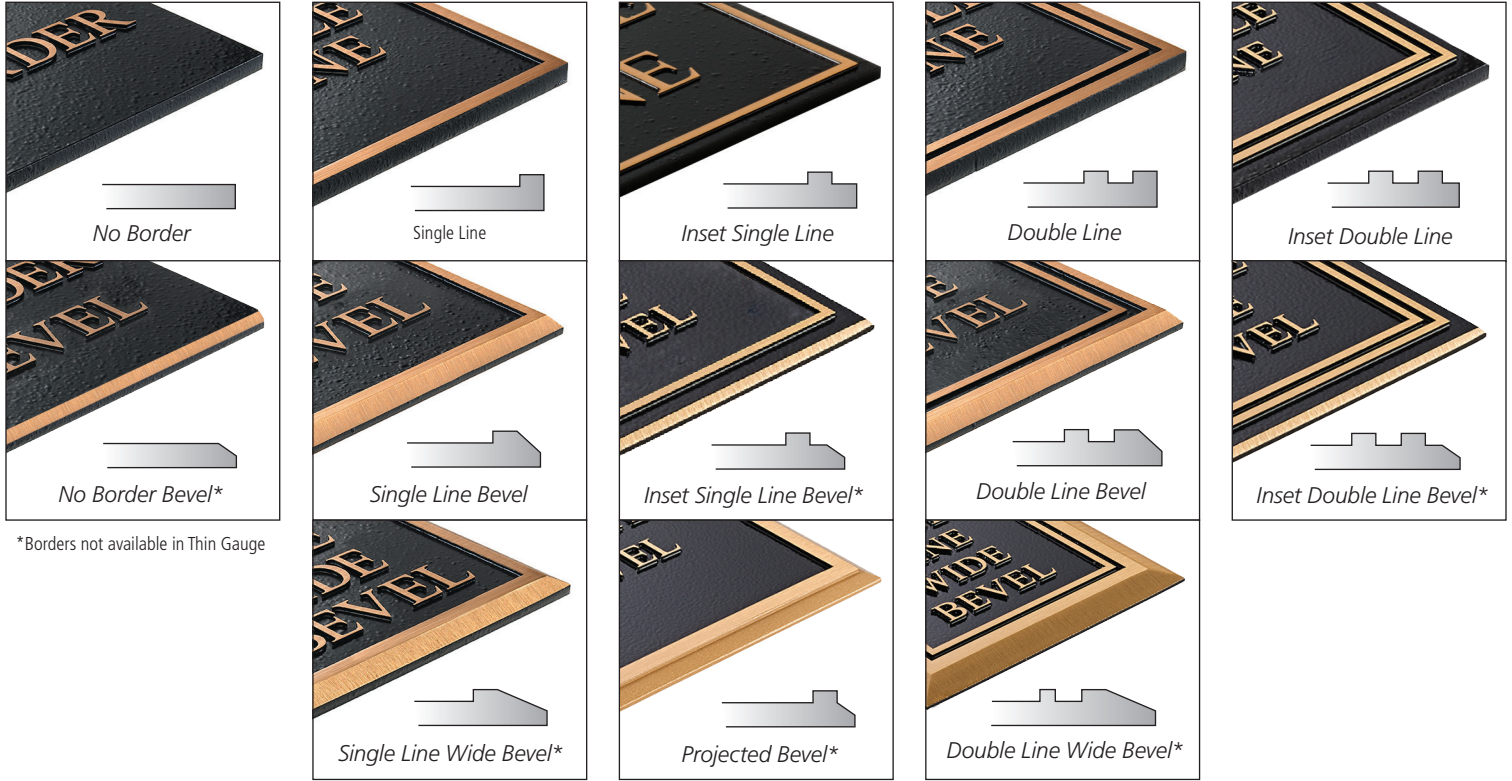

## Custom Borders

These precision tooled decorative borders are available for \$58. Other borders are also available. Please email for a quote.

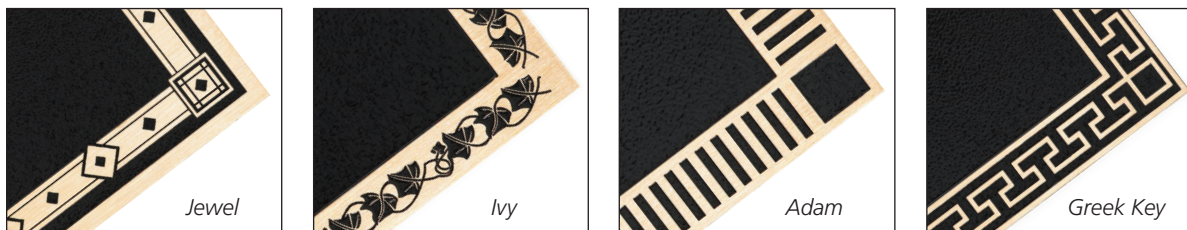

## Most Common Background Colors

Other standard painted colors shown on page 222. Custom colors available (\$200 per color swatch match).

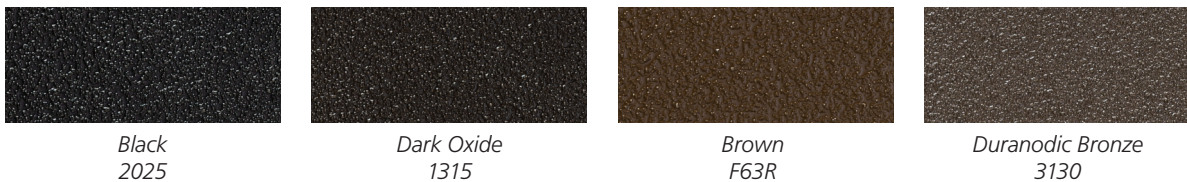



### Standard Finish Options

#### Brushed Finish

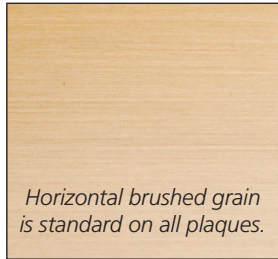

#### Edge Color



#### Clear Coat Options



Satin is standard on brushed finishes. Gloss is standard on polished finishes. Clear coat for harsh environments is also available upon request at no charge.

### Specialty Finish Options

#### Bronze Finishes

Oxidized finishes vary from order to order. Size limitations may apply.



Light Oxidized (+15%)



Oxidized (+15%)



Dark Oxidized (+15%)

Verde, Turquoise & Green Patina finishes available. Add 30% All patinas, by their very nature, will vary from plaque to plaque and order to order, and will change over time. Patina finishes may "bleed" onto the installation surface when installed outside.

#### Other Finishes



Flash Bronze (+15%)  
Interior Applications Only



Raised Painted Copy  
(Up to 2 additional colors  
- \$92per color)

**Multi-colored (4 colors or more)  
raised & recessed areas  
Email for quote**

#### Polished Finishes



Polished Bronze (+50%)



Polished Brass (+50%)  
Precision Tooled Only



Polished Aluminum (+50%)  
Precision Tooled Only

### Bronze, Brass & Aluminum Background Textures

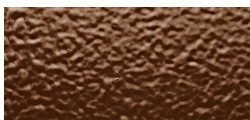

Leatherette

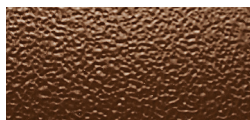

Stipple



Sand

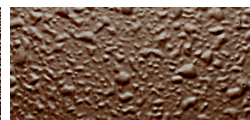

Pebble

## Surface Mounts

Plaques installed on stucco require spacers on studs. Installation tips can be found at GeminiSignage.com > Resources > Installation & Maintenance

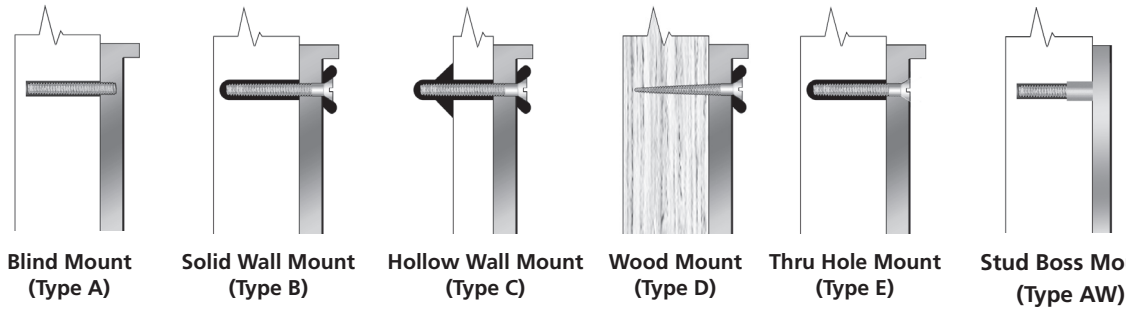

Drilled & Tapped

Plaques thinner than 1/4" can be stud mounted with welded stud bosses.

## Rosettes

Optional Rosettes are decorative covers for the screw heads, typically in each corner of bronze and aluminum plaques (included in price). Rosettes are available in 1/2", 3/4", 1" and 1-1/2" diameters. Rosettes with highlights are oxidized, aluminum rosettes are bead blasted. Screw heads are painted to match plaque background. Additional and replacement rosettes are \$27 each.

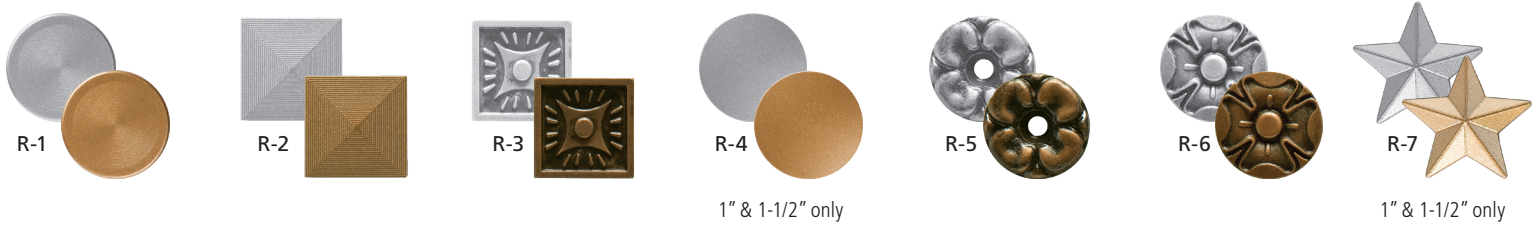

## Stake Mounts

### Garden Stake Mount (Type E)

Machine screws through 5/16" thick black anodized stakes into back of plaque. Maximum plaque size is 12" x 8" for one stake or 20" x 8" for two stakes. Minimum plaque height is 4"



### GARDEN STAKES

24"	\$104 ea.
36"	\$122 ea.
48"	\$144 ea.

### Post Mount (Type F)

Black painted aluminum brackets attach to back of plaque with machine screws. Aluminum square post bolts into bracket at a 45° or 90° angle. Plaques over 24" wide require two posts. 1" Post is on a 4" x 6" bracket. 1-1/2" Post is on a 5" x 7" bracket. 2" Post is on a 6" x 8" bracket.

### POST MOUNTS

For plaques up to 250 sq. in.	
6' x 1" Post	\$170
8' x 1" Post	\$227
For plaques up to 450 sq. in.	
6' x 1-1/2" Post	\$221
8' x 1-1/2" Post	\$294
For plaques up to 720 sq. in.	
6' x 2" Post	\$255
8' x 2" Post	\$340









## Portrait & Image Options

### Bas Relief

We start with a photograph. (Although we can use almost any quality photograph, the better the image, the better the modeling effort.) The finished image will be an artist's interpretation of your photograph. An image of the clay model is sent to you via email for your comments or approval. When approved, the clay model is used for the **cast bronze or aluminum** casting process. The bas relief is mechanically attached to the cast plaque background. Not available in Flash Bronze aluminum. (Standard overall height of 4" to 24" with a finished depth of 3/4" to 1". Price shown does not include the cost of the plaque)

SIZE	Single Head	Double Head
4"	\$1,905	\$2,657
6"	1,905	2,657
7"	1,905	2,657
8"	1,905	2,657
9"	1,905	2,657
10"	1,905	2,657
11"	2,062	2,867
12"	2,185	3,241
14"	2,594	3,372
16"	2,963	3,809
18"	3,248	4,230
20"	3,576	4,678
22"	3,902	5,077
24"	4,230	5,500

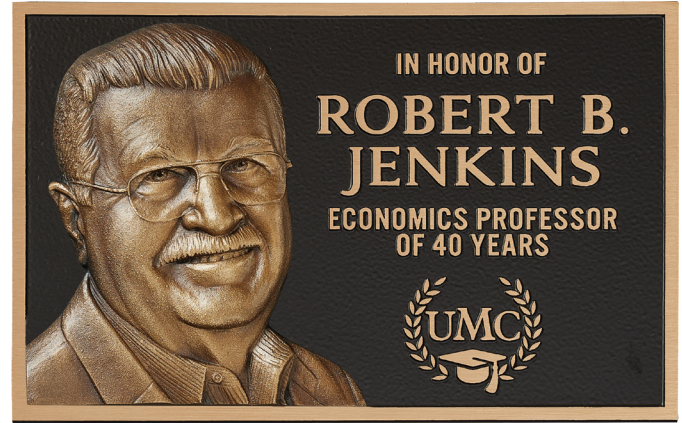

### Flat Relief

An economic alternative to the bas relief, Gemini's flat relief plaques are two-dimensional images that are part of a plaque. The process starts with a good quality photograph or illustration from which our artists create a black and white rendering. Suitable for interior or exterior applications, they perfectly fit the bill when your plaque requires a portrait but the budget won't allow for bas relief. Up to 10" - \$443. Larger than 10", email for quote. Level of detail will be based on size and preference. Price shown does not include the cost of the plaque.

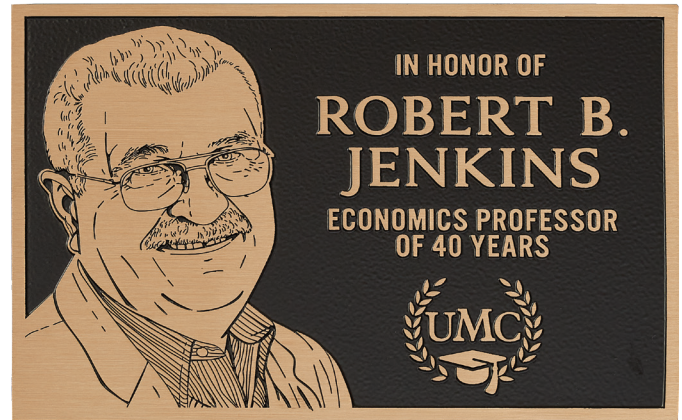

### PhotoRelief™

A seamless blend of casting and photography, PhotoRelief™ is perfectly suited for unique signage, historical markers, or any plaque that needs to tell a story with words and pictures. Through Gemini's innovative technologies, we can use one or more photographs to create a simple and elegant plaque or a breathtaking collage that illustrates the saying "a picture is worth a thousand words." (High quality / resolution photo required) Up to 36" x 24". Additional lead time may apply.

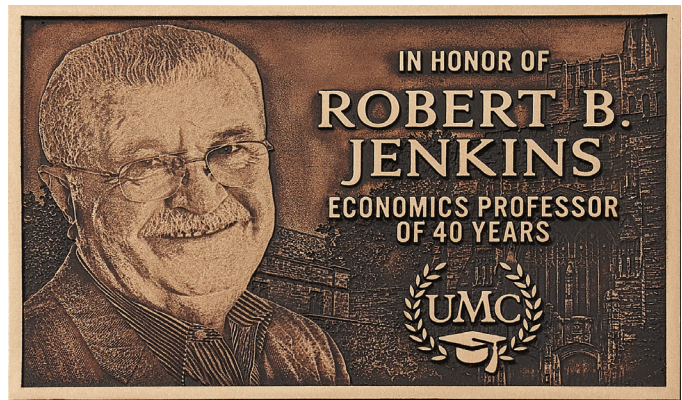

*PhotoRelief Pricing: page 257*

### Etched Portrait on Metal

The etching process allows you to forever replicate your photograph, line drawing or complex artwork in beautiful detail. This method utilizes a halftone dot pattern made from a 50-line screen. Halftone portraits resemble newspaper photographs, and have visible dot patterns. The etched, recessed dots are filled with black paint to contrast with the brushed finish of the metal background. The best photographs for halftone etched portraits have high contrast tones with bright white areas, dense black areas and minimal gray tones. (Photos that are monotone or have muted colors will produce poor halftone etchings.) Halftone etchings are available in **stainless steel, bronze and brass**. Up to 10" - \$449 - Larger than 10", call or email for quote. Price shown does not include the cost of the plaque

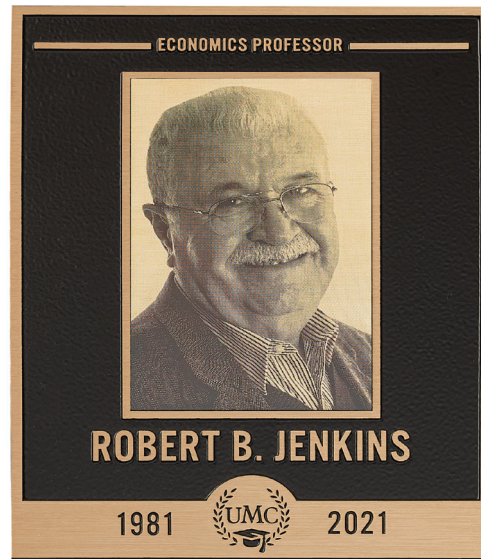

### UV Print Insert

Gemini can apply your images as inserts into your architectural plaques. Our hi-resolution printers render UV-cured, non-elastic inks at up to 1200 dpi.

The combination of our high-resolution printing and premium base materials results in a picture perfect product that is excellent for all indoor applications and even some exterior ones.

Up to 10" x 10" - \$104.

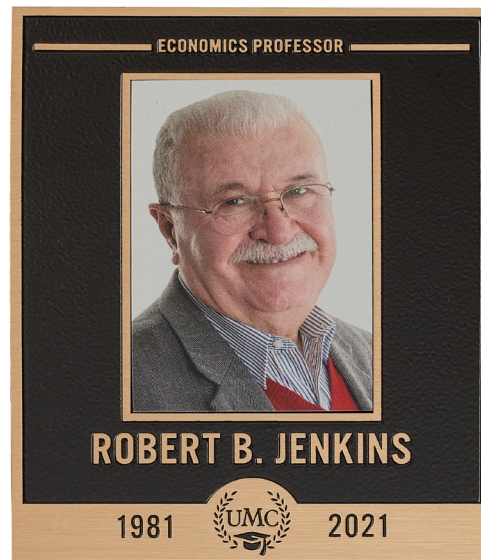

### Oval & Rectangular Ceramic Inserts

A standard-sized blank base with a full-color digital transfer applied to the blank. Additional lead time may apply.

SHAPE	SIZE	PRICE	SHAPE	SIZE	PRICE
Rectangle	2.3" X 3.1"	\$428	Oval	2.3" x 3.1"	\$395
Rectangle	2.7" x 3.5"	431	Oval	2.7" x 3.5"	398
Rectangle	3.1" X 3.9"	431	Oval	3.1" x 3.9"	398
Rectangle	3.5" X 4.7"	433	Oval	3.5" x 4.7"	400
Rectangle	4.3" x 5.9"	456	Oval	4.3" x 5.9"	420
Rectangle	5.1" x 7.1"	480	Oval	5.1" x 7.1"	443
Rectangle	7.1" x 9.4"	673	Oval	7.1" x 9.4"	620

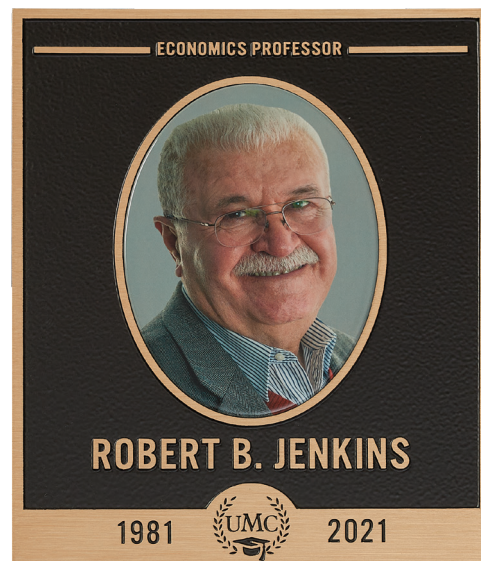



# Precision Tooled Bronze Pricing

The tables on these pages show base pricing for our precision tooled brushed finish bronze plaques. Use the information below to calculate the price for any specialty features. For questions and custom quotes, please email [Plaques@GeminiMade.com](mailto:Plaques@GeminiMade.com)

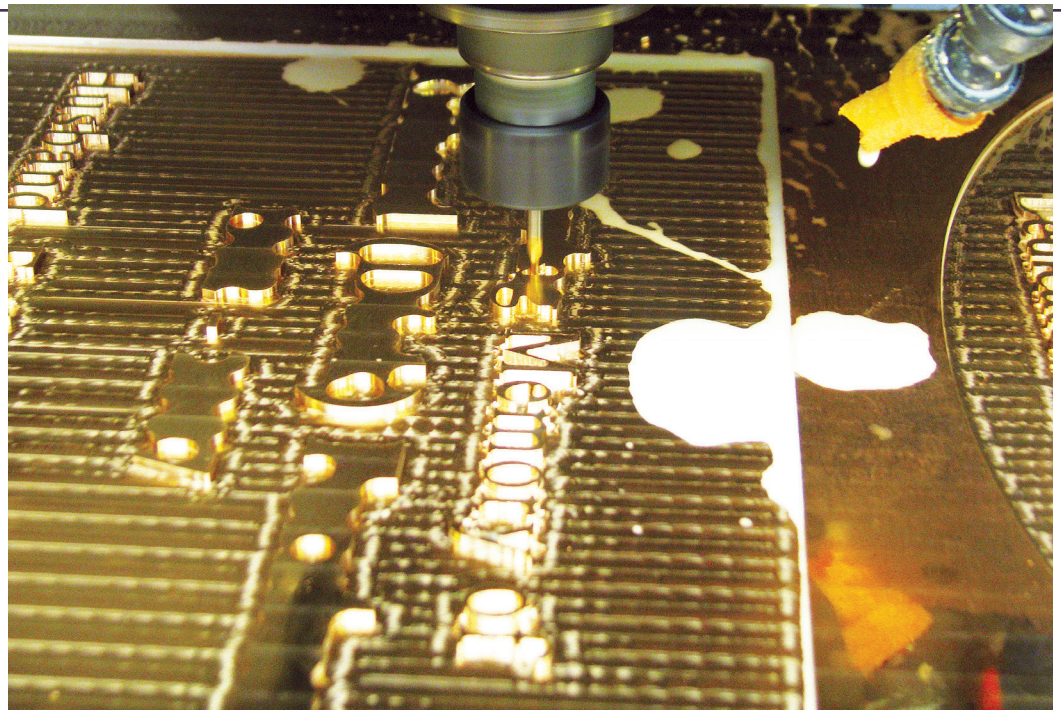

**TrueQuote!**  
Online price calculator

GeminiSignage.com

## Included With Your Order

- Custom Size & Shape
- Standard Border & Brushed Finish
- One Standard Background/Edge Color
- One Artwork Proof
- Appropriate Packaging

## Additional Options

- Garden Stake Mount
  - 24" stake = \$104
  - 36" stake = \$122
  - 48" stake = \$144
- Post Mount
  - 1" x 6' = \$170
  - 1" x 8' = \$227
  - 1.5" x 6' = \$221
  - 1.5" x 8' = \$294
  - 2" x 6' = \$255
  - 2" x 8' = \$340
- Mounting Patterns
  - Up to 12" = \$19
  - 13" - 23" = \$39
  - 24"+ = \$59
- Custom Border \$58
- Up to 2 additional paint colors \$92/color
- Polished Face +50%
- Polished Bevel Edge +20%
- Oxidized finish +15%
- Patina finish +30%
- Double-sided plaques +125%

## Precision Tooled Bronze Pricing

1/4" Depth     5/16" Depth

1/8" Depth available up to 18" x 18"

	2"	3"	4"	5"	6"	7"	8"	9"	10"	12"	14"	15"	16"	18"	20"
2"	\$146	\$146	\$146	\$146	\$146	\$146	\$146	\$146	\$146	\$146	\$183	\$192	\$195	\$206	\$241
3"	146	146	146	146	146	146	146	177	191	206	265	278	288	297	353
4"	146	146	146	146	146	183	195	196	222	257	316	332	334	358	424
5"	146	146	146	168	191	196	222	234	268	323	355	473	472	474	516
6"	146	146	146	191	196	257	258	305	323	356	355	474	478	479	544
7"	146	146	183	196	257	330	331	334	364	433	479	583	588	666	719
8"	146	146	195	222	258	331	358	359	372	436	481	587	591	672	725
9"	146	177	196	234	305	334	359	374	408	485	603	648	672	727	760
10"	146	191	222	268	323	364	372	408	449	518	605	650	675	756	832
12"	146	206	257	323	356	433	436	485	518	639	700	737	825	895	996
14"	183	265	316	355	355	479	481	603	605	700	811	852	929	1,047	1,158
15"	192	278	332	473	474	583	587	648	650	737	852	932	973	1,113	1,240
16"	195	288	334	472	478	588	591	672	675	825	929	973	1,053	1,181	1,342
18"	206	297	358	474	479	666	672	727	756	895	1,047	1,113	1,181	1,358	1,509
20"	241	353	424	516	544	719	725	760	832	996	1,158	1,240	1,342	1,509	1,676
22"	463	465	466	674	675	748	751	768	835	1,089	1,275	1,436	1,461	1,636	1,851
24"	467	468	470	751	754	768	797	843	996	1,184	1,410	1,492	1,612	1,807	2,010
26"	664	666	673	771	772	783	890	1,004	1,112	1,354	1,584	1,696	1,806	1,956	2,263
28"	666	674	680	772	777	843	944	1,077	1,143	1,392	1,708	1,829	1,946	2,116	2,319
30"	669	677	681	777	780	901	984	1,144	1,260	1,509	1,828	1,957	2,090	2,268	2,509
32"	680	681	738	789	824	956	1,092	1,230	1,390	1,661	1,946	2,090	2,227	2,496	2,767
34"	787	792	796	800	853	1,021	1,121	1,312	1,477	1,669	2,068	2,218	2,365	2,510	2,780
36"	794	796	827	835	888	1,079	1,215	1,384	1,562	1,807	2,190	2,354	2,510	2,715	3,007
38"	815	817	853	856	977	1,137	1,294	1,465	1,649	1,986	2,314	2,483	2,648	2,977	3,305
40"	852	855	859	863	1,028	1,196	1,390	1,567	1,733	2,090	2,435	2,610	2,780	3,132	3,478

\*Oversize charges will apply





Our bronze alloy is **Lead-Free**

**How to Use These Tables**

Prices shown are for one plaque with a brushed finish, standard border and background color. For special sizes not shown, use the next largest plaque price. For example, a 17" x 30" plaque would be priced as 18" x 30".



**Pricing Example**

- 30" x 17"
- Price as 30" x 18"

\$2,268 list price



Lead-free Alloy 22000



Lead-free C46400

**Precision Tooled Bronze Pricing**

1/4" Depth     5/16" Depth

	22"	24"	26"	28"	30"	32"	34"	36**	38**	40**	42**	44**	46**	48**	50**	52**	54**	56**	58**	60**	62**	64**	>64"
2"	\$463	\$467	\$664	\$666	\$669	\$680	\$787	\$794	\$815	\$852	\$921	\$964	\$1,009	\$1,053	\$1,095	\$1,212	\$1,276	\$1,363	\$1,421	\$1,515	\$1,567	\$1,618	
3"	465	468	666	674	677	681	792	796	817	855	923	969	1,010	1,056	1,116	1,240	1,285	1,398	1,466	1,545	1,590	1,642	
4"	466	470	673	680	681	738	796	827	853	859	928	973	1,017	1,061	1,240	1,289	1,320	1,412	1,522	1,561	1,611	1,659	
5"	674	751	771	772	777	789	800	835	856	863	931	978	1,023	1,067	1,280	1,306	1,326	1,493	1,554	1,614	1,660	1,711	
6"	675	754	772	777	780	824	853	888	977	1,028	1,109	1,164	1,216	1,266	1,363	1,413	1,470	1,526	1,581	1,633	1,687	1,744	
7"	748	768	783	843	901	956	1,021	1,079	1,137	1,196	1,323	1,382	1,446	1,508	1,590	1,651	1,717	1,781	1,845	1,906	1,961	2,022	
8"	751	797	890	944	984	1,092	1,121	1,215	1,294	1,390	1,508	1,580	1,649	1,721	1,817	1,887	1,963	2,031	2,108	2,182	2,240	2,312	
9"	768	843	1,004	1,077	1,144	1,230	1,312	1,384	1,465	1,567	1,694	1,779	1,854	1,934	2,039	2,126	2,207	2,285	2,370	2,450	2,519	2,599	
10"	835	996	1,112	1,143	1,260	1,390	1,477	1,562	1,649	1,733	1,882	1,970	2,063	2,151	2,267	2,359	2,451	2,541	2,630	2,726	2,800	2,886	
12"	1,089	1,184	1,354	1,392	1,509	1,661	1,669	1,807	1,986	2,090	2,259	2,370	2,472	2,581	2,726	2,832	2,939	3,051	3,158	3,261	3,360	3,464	
14"	1,275	1,410	1,584	1,708	1,828	1,946	2,068	2,190	2,314	2,435	2,637	2,760	2,885	3,008	3,175	3,298	3,431	3,557	3,681	3,810	3,915	4,040	
15"	1,436	1,492	1,696	1,829	1,957	2,090	2,218	2,354	2,483	2,610	2,824	2,957	3,092	3,225	3,404	3,537	3,671	3,810	3,946	4,079	4,197	4,331	
16"	1,461	1,612	1,806	1,946	2,090	2,227	2,365	2,510	2,648	2,780	3,008	3,153	3,296	3,440	3,626	3,774	3,917	4,063	4,208	4,354	4,474	4,618	
18"	1,636	1,807	1,956	2,116	2,268	2,496	2,510	2,715	2,977	3,132	3,388	3,548	3,709	3,871	4,080	4,242	4,407	4,571	4,736	4,897	5,035	5,145	
20"	1,851	2,010	2,263	2,319	2,509	2,767	2,780	3,007	3,305	3,478	3,761	3,942	4,122	4,302	4,536	4,717	4,897	5,080	5,259	5,442	5,595	5,773	
22"	2,108	2,227	2,488	2,684	2,780	3,062	3,255	3,341	3,537	3,830	4,140	4,334	4,531	4,731	4,988	5,188	5,389	5,587	5,787	5,989	6,155	6,351	
24"	2,227	2,408	2,715	2,791	3,017	3,325	3,341	3,615	3,968	4,175	4,514	4,730	4,940	5,159	5,443	5,659	5,873	6,093	6,310	6,524	6,712	6,926	
26"	2,488	2,715	2,977	3,202	3,436	3,450	3,742	4,116	4,347	4,368	4,951	5,188	5,421	5,657	5,892	6,127	6,362	6,598	6,832	7,070	7,398	7,636	
28"	2,684	2,791	3,202	3,455	3,461	3,946	4,188	4,194	4,528	4,744	5,336	5,585	5,838	6,171	6,430	6,684	6,945	7,253	7,457	7,716	7,930	8,186	
30"	2,780	3,017	3,436	3,461	3,742	4,207	4,227	4,576	4,915	4,968	5,712	5,986	6,255	6,524	6,796	7,070	7,347	7,617	8,025	8,898	8,954	8,999	
32"	3,062	3,325	3,450	3,946	4,207	4,503	4,787	5,067	5,348	5,633	6,093	6,386	6,674	7,460	7,770	8,082	8,391	8,698	9,172	9,488	9,754	10,066	
34"	3,255	3,341	3,742	4,188	4,227	4,787	5,087	5,178	5,684	5,980	6,472	6,784	7,596	7,876	8,254	8,737	9,075	9,409	9,747	10,082	10,602	10,654	
36**	3,341	3,615	4,116	4,194	4,576	5,067	5,178	5,451	6,017	6,301	6,516	7,692	7,794	7,924	8,897	9,252	9,491	9,964	10,010	10,602	10,654	10,707	
38**	3,537	3,968	4,347	4,528	4,915	5,348	5,684	6,017	6,355	7,161	7,750	8,119	8,540	8,910	9,389	9,765	10,141	10,517	10,890	11,268	11,580	11,957	
40**	3,830	4,175	4,368	4,744	4,968	5,633	5,980	6,301	7,161	7,541	8,161	8,598	8,984	9,378	9,886	10,278	10,381	11,068	11,350	11,743	12,070	12,460	

EMAIL FOR QUOTE

\*Oversize charges will apply

# Precision Tooled Aluminum Pricing

The tables on these pages show base pricing for our precision tooled brushed finish aluminum plaques. Use the information below to calculate the price for any specialty features. For questions and custom quotes, please email [Plaques@GeminiMade.com](mailto:Plaques@GeminiMade.com)

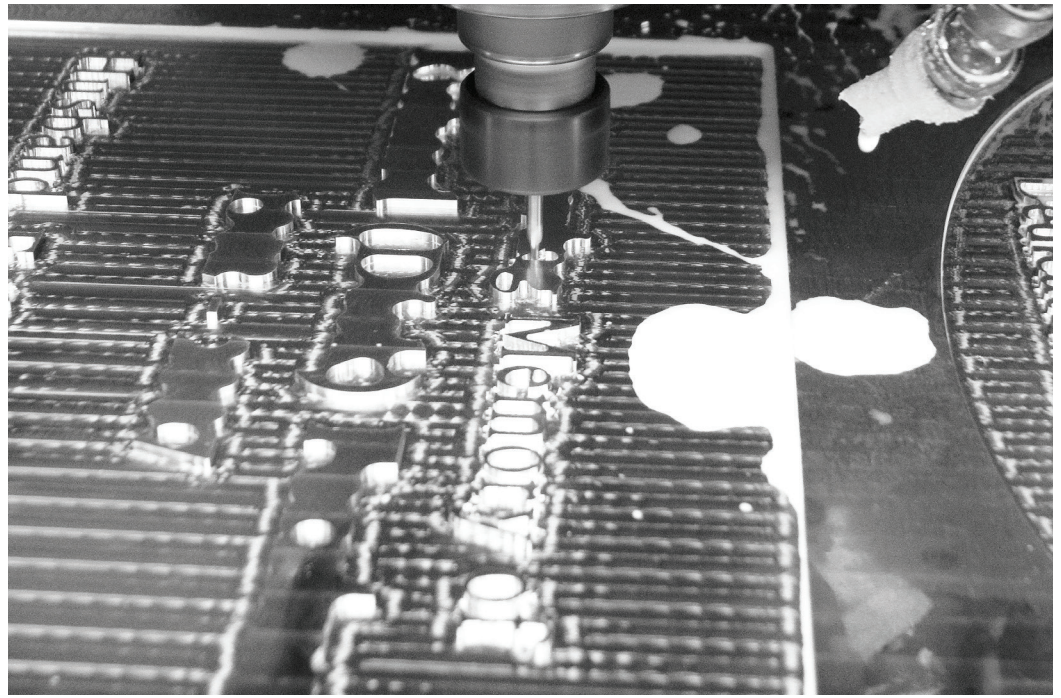

**TrueQuote!**  
Online price calculator



[GeminiSignage.com](http://GeminiSignage.com)

## Included With Your Order

- Custom Size & Shape
- Standard Border & Brushed Finish
- One Standard Background/Edge Color
- One Artwork Proof
- Appropriate Packaging

## Additional Options

- Garden Stake Mount
  - 24" stake = \$104
  - 36" stake = \$122
  - 48" stake = \$144
- Post Mount
  - 1" x 6' = \$170
  - 1" x 8' = \$227
  - 1.5" x 6' = \$221
  - 1.5" x 8' = \$294
  - 2" x 6' = \$255
  - 2" x 8' = \$340
- Mounting Patterns
  - Up to 12" = \$19
  - 13" - 23" = \$39
  - 24"+ = \$59
- Custom Border \$58
- Up to 2 additional paint colors \$92/color
- Polished Face +50%
- Polished Bevel Edge +20%
- Double-sided plaques +125%

## Precision Tooled Aluminum Pricing

	2"	3"	4"	5"	6"	7"	8"	9"	10"	12"	14"	15"	16"	18"	20"
2"	\$101	\$101	\$101	\$101	\$101	\$101	\$101	\$101	\$101	\$101	\$114	\$120	\$121	\$126	\$138
3"	101	101	101	101	101	101	101	112	118	126	188	197	198	218	236
4"	101	101	101	101	101	114	121	124	138	161	189	198	199	219	237
5"	101	101	101	101	118	124	138	145	163	197	256	283	284	284	304
6"	101	101	101	118	124	161	162	183	197	235	259	284	286	287	308
7"	101	101	114	124	161	198	199	199	236	255	322	326	327	371	401
8"	101	101	121	138	162	199	200	218	237	256	323	327	327	373	403
9"	101	112	124	145	183	199	218	237	266	289	335	362	385	421	446
10"	101	118	138	163	197	236	237	266	269	320	338	364	388	424	458
12"	101	126	161	197	235	255	256	289	320	372	405	426	462	494	554
14"	114	188	189	256	259	322	323	335	338	405	460	497	512	579	658
15"	120	197	198	283	284	326	327	362	364	426	497	544	566	634	708
16"	121	198	199	284	286	327	327	385	388	462	512	566	599	674	742
18"	126	218	219	284	287	371	373	421	424	494	579	634	674	754	839
20"	138	236	237	304	308	401	403	446	458	554	658	708	742	839	931
22"	258	258	260	376	379	417	419	448	485	622	706	813	822	914	1,038
24"	259	260	261	419	421	443	445	489	554	676	781	866	890	1,031	1,146
26"	372	378	381	431	436	454	497	583	622	760	884	989	1,010	1,109	1,312
28"	375	379	383	433	437	489	527	629	634	782	952	1,064	1,084	1,203	1,343
30"	376	381	384	436	438	521	566	666	697	839	1,018	1,139	1,189	1,293	1,428
32"	378	382	387	458	462	560	615	719	778	931	1,084	1,216	1,269	1,453	1,619
34"	440	443	445	462	478	592	627	764	827	935	1,157	1,290	1,348	1,460	1,626
36"*	440	443	445	464	497	626	671	807	871	1,001	1,245	1,367	1,424	1,545	1,717
38"*	474	475	478	480	546	662	721	854	921	1,109	1,418	1,445	1,507	1,724	1,916
40"*	493	497	498	500	573	697	778	909	974	1,189	1,426	1,520	1,587	1,815	2,020

\*Oversize charges will apply

**How to Use These Tables**

Prices shown are for one plaque with a brushed finish, standard border and background color. For special sizes not shown, use the next largest plaque price. For example, a 17" x 30" plaque would be priced as 18" x 30".



**Pricing Example**

- 30" x 17"
- Price as 30" x 18"

\$1,293 list price



Alloy 5052-H32



Flash Bronze (+15%)  
INTERIOR APPLICATIONS ONLY

All plaques are either 1/4" or 5/16" deep.

1/8" Depth available up to 18" x 18"

	22"	24"	26"	28"	30"	32"	34"	36"*	38"*	40"*	42"*	44"*	46"*	48"*	50"*	52"*	54"*	56"*	58"*	60"*	62"*	64"*	>64"
2"	\$258	\$259	\$372	\$375	\$376	\$378	\$440	\$440	\$474	\$493	\$522	\$544	\$571	\$596	\$608	\$672	\$708	\$757	\$792	\$846	\$868	\$901	
3"	258	260	378	379	381	382	443	443	475	497	525	547	573	599	622	690	714	778	816	859	885	909	
4"	260	261	381	383	384	387	445	445	478	498	527	550	577	603	690	715	731	790	848	865	891	921	
5"	376	419	431	433	436	458	462	464	480	500	529	553	579	607	711	724	738	831	862	901	927	956	
6"	379	421	436	437	438	462	478	497	546	573	605	632	660	690	760	791	813	862	891	921	951	982	
7"	417	443	454	489	521	560	592	626	662	697	748	782	818	856	901	932	972	1,007	1,039	1,076	1,111	1,145	
8"	419	445	497	527	566	615	627	671	721	778	818	858	896	934	1,026	1,067	1,109	1,148	1,191	1,232	1,269	1,311	
9"	448	489	583	629	666	719	764	807	854	909	962	1,008	1,054	1,099	1,154	1,200	1,245	1,290	1,337	1,384	1,428	1,475	
10"	485	554	622	634	697	778	827	871	921	974	1,024	1,073	1,121	1,194	1,280	1,333	1,384	1,434	1,485	1,536	1,585	1,636	
12"	622	676	760	782	839	931	935	1,001	1,109	1,189	1,252	1,311	1,371	1,430	1,536	1,600	1,622	1,721	1,784	1,839	1,901	1,962	
14"	706	781	884	952	1,018	1,084	1,157	1,245	1,418	1,426	1,460	1,531	1,601	1,668	1,794	1,868	1,937	2,008	2,082	2,152	2,217	2,290	
15"	813	866	989	1,064	1,139	1,216	1,290	1,367	1,445	1,520	1,602	1,678	1,754	1,830	1,919	1,997	2,075	2,151	2,225	2,307	2,374	2,452	
16"	822	890	1,010	1,084	1,189	1,269	1,348	1,424	1,507	1,587	1,668	1,751	1,825	1,904	2,051	2,130	2,212	2,295	2,374	2,458	2,534	2,615	
18"	914	1,031	1,109	1,203	1,293	1,453	1,460	1,545	1,724	1,815	1,912	2,004	2,095	2,186	2,307	2,397	2,482	2,583	2,674	2,767	2,852	2,919	
20"	1,038	1,146	1,312	1,343	1,428	1,619	1,626	1,717	1,916	2,020	2,124	2,227	2,327	2,426	2,562	2,665	2,767	2,869	2,971	3,074	3,166	3,269	
22"	1,201	1,294	1,443	1,556	1,619	1,776	1,888	1,936	2,054	2,219	2,341	2,451	2,560	2,674	2,818	2,933	3,042	3,155	3,267	3,380	3,485	3,598	
24"	1,294	1,377	1,574	1,622	1,720	1,936	1,946	2,060	2,301	2,421	2,548	2,674	2,794	2,918	3,074	3,195	3,305	3,441	3,565	3,686	3,802	3,923	
26"	1,443	1,574	1,726	1,860	1,992	1,998	2,070	2,387	2,517	2,533	2,785	2,919	3,050	3,183	3,328	3,463	3,595	3,730	3,862	3,996	4,118	4,251	
28"	1,556	1,622	1,860	1,999	2,004	2,287	2,426	2,432	2,529	2,545	2,998	3,140	3,282	3,429	3,587	3,730	3,873	4,016	4,157	4,301	4,436	4,577	
30"	1,619	1,720	1,992	2,004	2,132	2,451	2,451	2,531	2,851	2,883	3,215	3,363	3,520	3,668	3,840	3,995	4,130	4,301	4,455	4,938	5,090	5,255	
32"	1,776	1,936	1,998	2,287	2,451	2,615	2,775	2,941	3,100	3,264	3,429	3,594	3,756	4,197	4,390	4,567	4,741	4,913	5,090	5,267	5,448	5,475	
34"	1,888	1,946	2,070	2,426	2,451	2,775	2,949	3,002	3,298	3,463	3,643	3,817	4,273	4,435	4,664	4,855	5,037	5,224	5,408	5,671	5,684	5,698	
36"*	1,936	2,060	2,387	2,432	2,531	2,941	3,002	3,048	3,491	3,655	3,665	4,328	4,382	4,455	4,938	5,134	5,312	5,530	5,670	5,727	5,756	5,784	
38"*	2,054	2,301	2,517	2,529	2,851	3,100	3,298	3,491	3,683	4,152	4,364	4,571	4,773	4,983	5,212	5,419	5,628	5,837	6,046	6,253	6,448	6,656	
40"*	2,219	2,421	2,533	2,545	2,883	3,264	3,463	3,655	4,152	4,371	4,590	4,809	5,026	5,245	5,484	5,705	5,925	6,147	6,364	6,583	6,787	7,007	

EMAIL FOR QUOTE

\*Oversize charges will apply





## TIMELESS TRIBUTES

The sculpted, artistic qualities of casting cannot be matched by any other process. Gemini's artisans can transform 2D designs and images into realistic, dimensional and life-like impressions, producing timeless tributes that stand beautifully for generations.





# CAST PLAQUES

Integral sculpting and background textures

Greater depth & dimension

Sizes up to 96" circular diameter

Multiple castings of identical plaques offer discounts

Greater selection of border styles and mounting options

## SCULPTED WORKS OF ART

Metal casting is a 6,000-year-old art form that has stood the test of time. Our artisans sculpt molds that reflect a 3-dimensional expression of your artwork and manually pour molten bronze or aluminum from our nonpolluting electric foundry furnaces to produce a timeless, durable, one-piece work of art that is hand finished to exquisite results. Choose Gemini cast plaques for your projects that require a sculpted, multi-level surface, including faithful portrayals of people, images, scenes, and dimensional seals that will be forever immortalized in a timeless expression.

### WHEN ORDERING

PLEASE SPECIFY:

- Artwork & Critical Dimensions
- Material Selection
- Border Style
- Background Color & Texture
- Finish Selection
- Mounting Method

## Standard Borders

Border finish matches plaque copy. Other borders are also available. Email for a quote. (Illustrations not to scale) Edge color matches background color.

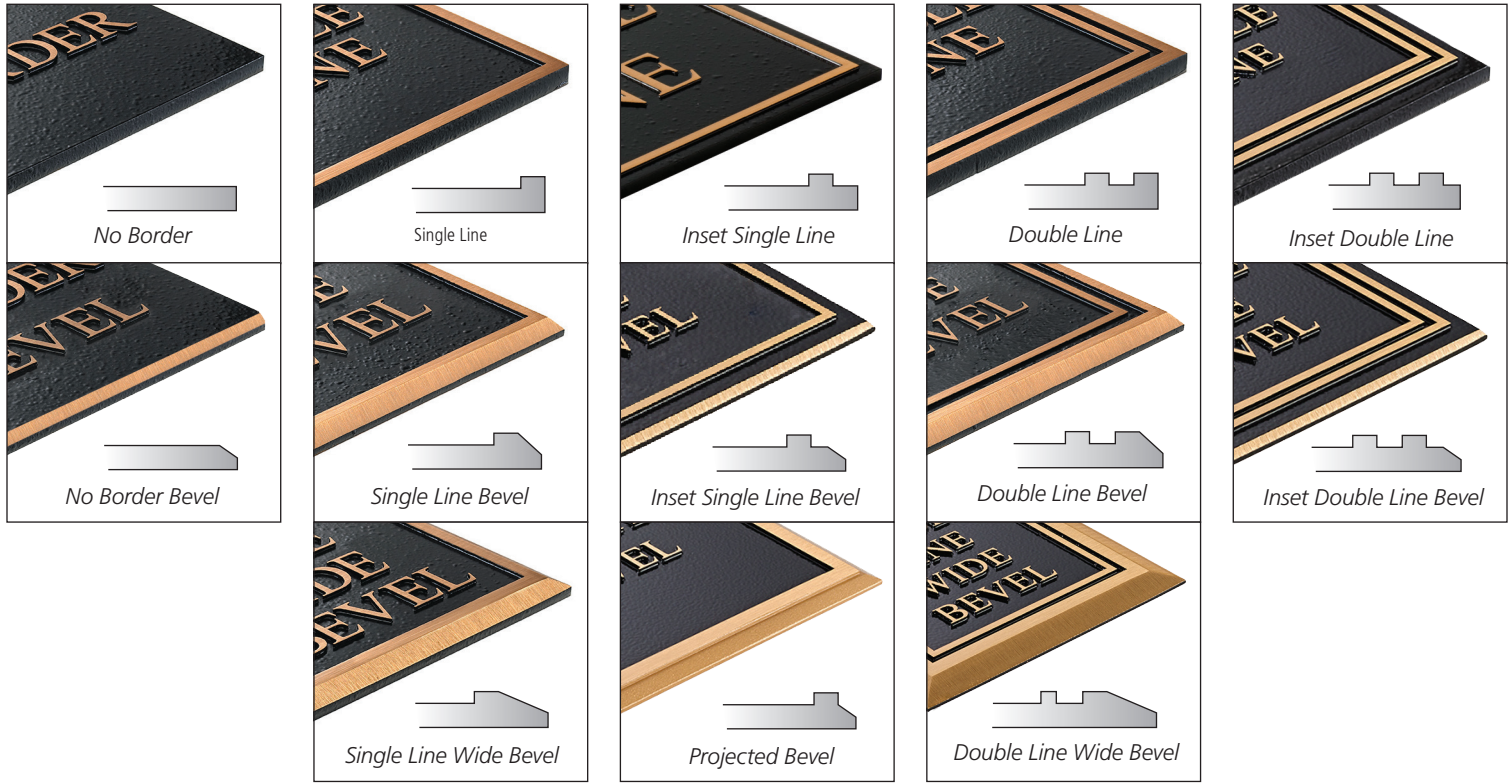

## Custom Borders

Cast sculpted borders available: \$4.90/linear inch



## Most Common Background Colors

Custom colors available (\$200 per color swatch match). Other standard colors - page 265.



Black  
2025



Dark Oxide  
1315

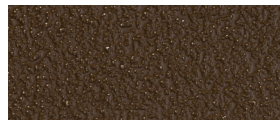

Brown  
F63R



Duranodic Bronze  
3130



## Standard Finish Options

### Brushed Finish

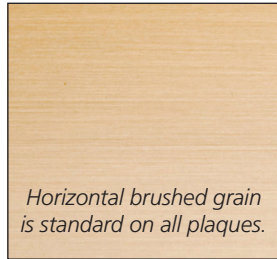

### Edge Color



### Clear Coat Options

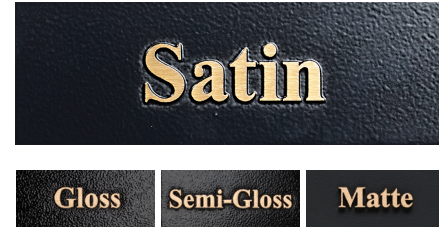

Satin is standard on brushed finishes. Gloss is standard on polished finishes. Matte is standard on PhotoRelief™. Clear coat for harsh environments is also available upon request at no charge.

## Specialty Finish Options

### Bronze Finishes

Oxidized finishes vary from order to order. Size limitations may apply.



Light Oxidized (+15%)



Oxidized (+15%)



Dark Oxidized (+15%)

Verde, Turquoise & Green Patina finishes available. Add 30% All patinas, by their very nature, will vary from plaque to plaque and order to order, and will change over time. Patina finishes may "bleed" onto the installation surface when installed outside.

### Other Finishes



Flash Bronze (+15%)  
Interior Applications Only



Raised Painted Copy  
(Up to 2 additional colors  
- \$92per color)

**Multi-colored (4 colors or more)  
raised & recessed areas  
Email for quote**

### Polished Finishes



Polished Bronze (+50%)



Buffed Aluminum (+50%)

## Bronze, Brass & Aluminum Background Textures

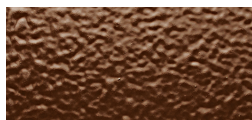

Leatherette  
(max. dimension 84")

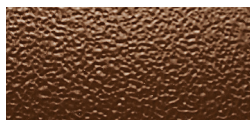

Stipple  
(max. dimension 84")



Sand

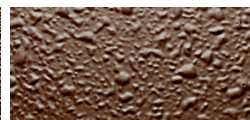

Pebble



Classic Leather  
(28" x 48" max.)

## Post Mounts

### Post Cap Mount (Type R)

Cast as part of an aluminum or bronze plaque, the post cap mount is designed to fit on 1-1/2", 2" or 3" ID schedule 40 posts. Available on almost any custom plaque, single or double-sided, up to 30" x 30" - 1/2" deep. Post are provided either galvanized or painted the plaque background color. Radius blade is standard (shown), angle and ogee blades also available. Add the pricing from the table below to your plaque price.

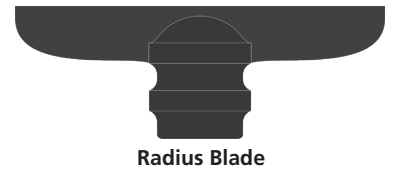
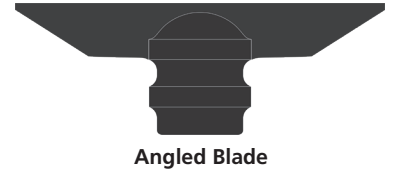

Max. Plaque Size	Blade Width	Post Cap Height	Post Cap I.D.	Schd. 40 Pipe I.D.	Post Cap Only	With 7' Post	With 8' Post	With 9' Post	With 10' Post
16" x 24"	10"	3-1/2"	2"	1-1/2"	\$257	\$431	\$519	\$604	\$693
24" x 30"	12"	4-3/4"	2-1/2"	2"	309	543	662	777	892
30" x 30"	18"	6-1/2"	3-5/8"	3"	358	709	1,000	1,207	1,583

(9' and 10' post ship truck only)

### Square Post Side Mount

The square post side mount is meant to provide a free standing plaque mount for plaques over 900 sq. in. Copy can be applied to front and back. For plaques with front copy only, the backs will be finished. Using two steel posts that are 4" x 4", plaques up to 36 sq ft can be free standing mounted. The square post side mount is a complete mounting system that ships with the plaque and includes the posts and hardware necessary for install. Assembly only requires common hand tools and can be done at the job site. Add the pricing from the table below to your plaque price. Cast plaques only.

Post Size	Max. Plaque Size	With 8' Posts
2" x 2"	1,512 sq/in	\$1,145
3" x 3"	2,160 sq/in	\$1,409
4" x 4"	5,040 sq/in	\$1,862



### Square Post Back Mount

The square post back mount is meant to provide a free standing plaque mount for single sided applications. Using two or three steel posts that are 3" x 3" or 4" x 4", plaques up to 36 sq ft can be free standing mounted. The square post back mount is a complete in-ground mounting system that ships with the plaque and includes the posts and hardware necessary for install. Optional base plates for surface mounting are available. Assembly only requires common hand tools and can be done at the job site. Add the pricing from the table below to your plaque price.

Post Size	Max. Plaque Size	With 8' Posts
2" x 2"	1,512 sq/in	\$634
3" x 3"	2,160 sq/in	\$900
4" x 4"	5,040 sq/in	\$1,171



## Surface Mounts

Plaques installed on stucco require spacers on studs. Installation tips can be found at GeminiSignage.com > Resources > Installation & Maintenance

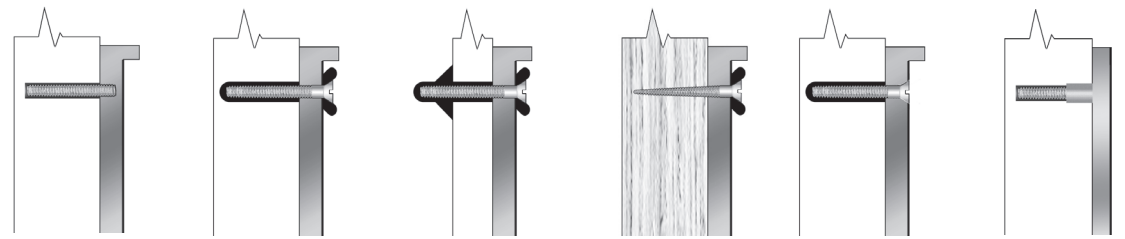

**Blind Mount (Type A)**

**Solid Wall Mount (Type B)**

**Hollow Wall Mount (Type C)**

**Wood Mount (Type D)**

**Thru Hole Mount (Type E)**

**Stud Boss Mount (Type AW)**

Drilled & Tapped

Plaques thinner than 1/4" can be stud mounted with welded stud bosses.

## Rosettes

Optional Rosettes are decorative covers for the screw heads, typically in each corner of bronze and aluminum plaques (included in price). Rosettes are available in 1/2", 3/4", 1" and 1-1/2" diameters. Rosettes with highlights are oxidized, aluminum rosettes are bead blasted. Screw heads are painted to match plaque background. Additional and replacement rosettes are \$27 each.



1" & 1-1/2" only

1" & 1-1/2" only

## Stake Mounts

### Garden Stake Mount (Type E)

Machine screws through 5/16" thick black anodized stakes into back of plaque. Maximum plaque size is 12" x 8" for one stake or 20" x 8" for two stakes. Minimum plaque height is 4"



### GARDEN STAKES

24"	\$104 ea.
36"	\$122 ea.
48"	\$144 ea.

### Post Mount (Type F)

Black painted aluminum brackets attach to back of plaque with machine screws. Aluminum square post bolts into bracket at a 45° or 90° angle. Plaques over 24" wide require two posts. 1" Post is on a 4" x 6" bracket. 1-1/2" Post is on a 5" x 7" bracket. 2" Post is on a 6" x 8" bracket.

### POST MOUNTS

For plaques up to 250 sq. in.	
6' x 1" Post	\$170
8' x 1" Post	\$227
For plaques up to 450 sq. in.	
6' x 1-1/2" Post	\$221
8' x 1-1/2" Post	\$294
For plaques up to 720 sq. in.	
6' x 2" Post	\$255
8' x 2" Post	\$340





# Cast Bronze Plaque Pricing

The tables on these pages show base pricing for our cast brushed finish bronze plaques. Use the information below to calculate the price for any specialty features. For questions and custom quotes, please email [Plaques@GeminiMade.com](mailto:Plaques@GeminiMade.com)



**TrueQuote!**  
Online price calculator

GeminiSignage.com

## Included With Your Order

- Custom Size & Shape
- Standard Border & Brushed Finish
- One Standard Background/Edge Color
- One Artwork Proof
- Appropriate Packaging

## Additional Options

- Garden Stake Mount
  - 24" stake = \$104
  - 36" stake = \$122
  - 48" stake = \$144
- Post Mount
  - 1" x 6' = \$170
  - 1" x 8' = \$227
  - 1.5" x 6' = \$221
  - 1.5" x 8' = \$294
  - 2" x 6' = \$255
  - 2" x 8' = \$340
- Mounting Patterns
  - Up to 12" = \$19
  - 13" - 23" = \$39
  - 24"+ = \$59
- Custom Border \$58
- Up to 2 additional paint colors \$92/color
- Polished Face +50%
- Polished Bevel Edge +20%
- Oxidized finish +15%
- Patina finish +30%

## Cast Bronze Pricing

	2"	3"	4"	5"	6"	7"	8"	9"	10"	12"	14"	15"	16"	18"	20"
2"	\$162	\$162	\$162	\$162	\$162	\$162	\$162	\$162	\$162	\$162	\$200	\$210	\$214	\$229	\$266
3"	162	162	162	162	162	162	162	195	208	229	293	305	317	329	389
4"	162	162	162	162	162	200	214	216	247	284	350	366	368	395	467
5"	162	162	162	185	208	216	247	257	296	359	393	521	523	524	572
6"	162	162	162	208	216	284	285	336	359	393	395	523	526	527	603
7"	162	162	200	216	284	364	366	368	404	479	529	645	648	739	791
8"	162	162	214	247	285	366	395	397	413	484	532	648	652	742	801
9"	162	195	216	257	336	368	397	413	451	535	667	715	744	803	838
10"	162	208	247	296	359	404	413	451	496	573	669	717	748	835	918
12"	162	229	284	359	393	479	484	535	573	705	774	813	911	989	1,100
14"	200	293	350	393	395	529	532	667	669	774	898	941	1,028	1,156	1,278
15"	210	305	366	521	523	645	648	715	717	813	941	1,030	1,077	1,227	1,370
16"	214	317	368	523	526	648	652	744	748	911	1,028	1,077	1,165	1,305	1,482
18"	229	329	395	524	527	739	742	803	835	989	1,156	1,227	1,305	1,497	1,670
20"	266	389	467	572	603	791	801	838	918	1,100	1,278	1,370	1,482	1,670	1,854
22"	509	511	512	744	746	825	828	849	923	1,203	1,408	1,590	1,615	1,805	2,046
24"	514	515	516	828	831	844	878	928	1,100	1,308	1,557	1,648	1,782	1,994	2,222
26"	734	739	744	850	851	865	985	1,108	1,227	1,496	1,746	1,875	1,994	2,157	2,502
28"	737	743	753	851	855	928	1,042	1,189	1,261	1,539	1,883	2,019	2,149	2,334	2,562
30"	741	747	755	855	860	995	1,085	1,263	1,391	1,670	2,016	2,160	2,309	2,505	2,771
32"	753	755	817	872	910	1,056	1,209	1,360	1,538	1,832	2,149	2,309	2,461	2,755	3,057
34"	869	874	879	884	942	1,128	1,237	1,447	1,631	1,841	2,286	2,446	2,612	2,770	3,073
36"*	877	879	914	922	980	1,191	1,341	1,525	1,725	1,994	2,421	2,597	2,770	2,997	3,322
38"*	899	901	941	945	1,078	1,256	1,432	1,617	1,822	2,192	2,557	2,741	2,924	3,288	3,652
40"*	944	946	950	955	1,135	1,321	1,538	1,732	1,916	2,309	2,690	2,882	3,073	3,460	3,843

\*Oversize charges will apply

## How to Use These Tables

Prices shown are for one plaque with a brushed finish, standard border and background color. For special sizes not shown, use the next largest plaque price. For example, a 17" x 30" plaque would be priced as 18" x 30". For duplicate cast plaques on a single order (up to 40" x 64" maximum size) email for review on pricing.



### Pricing Example

- 30" x 17" Plaque
- Price as 30" x 18"

\$2,505 list price



Lead-free Alloy C90300  
"Navy G"



Our bronze alloy is  
**Lead-Free**

### STANDARD DEPTHS:

Less than 324 sq. inches = 5/16" Depth  
 324 - 575 sq. inches = 1/2" Depth  
 576 - 1,295 sq. inches = 3/4" Depth  
 Over 1,295 sq. inches = 1" Depth

	22"	24"	26"	28"	30"	32"	34"	36"*	38"*	40"*	42"*	44"*	46"*	48"*	50"*	52"*	54"*	56"*	58"*	60"*	62"*	64"*	>64"
2"	\$509	\$514	\$734	\$737	\$741	\$753	\$869	\$877	\$899	\$944	\$985	\$1,035	\$1,082	\$1,126	\$1,173	\$1,299	\$1,368	\$1,460	\$1,521	\$1,623	\$1,678	\$1,732	
3"	511	515	739	743	747	755	874	879	901	946	987	1,040	1,084	1,129	1,196	1,327	1,376	1,498	1,570	1,654	1,702	1,757	
4"	512	516	744	753	755	817	879	914	941	950	992	1,044	1,090	1,135	1,327	1,380	1,411	1,515	1,629	1,670	1,723	1,778	
5"	744	828	850	851	855	872	884	922	945	955	996	1,049	1,097	1,140	1,371	1,400	1,419	1,598	1,662	1,727	1,780	1,837	
6"	746	831	851	855	860	910	942	980	1,078	1,135	1,188	1,244	1,303	1,355	1,460	1,517	1,578	1,634	1,695	1,752	1,807	1,866	
7"	825	844	865	928	995	1,056	1,128	1,191	1,256	1,321	1,414	1,480	1,550	1,617	1,702	1,769	1,840	1,908	1,976	2,040	2,099	2,167	
8"	828	878	985	1,042	1,085	1,209	1,237	1,341	1,432	1,538	1,617	1,693	1,765	1,841	1,945	2,021	2,101	2,175	2,258	2,335	2,395	2,477	
9"	849	928	1,108	1,189	1,263	1,360	1,447	1,525	1,617	1,732	1,816	1,904	1,987	2,072	2,187	2,275	2,361	2,448	2,537	2,625	2,697	2,782	
10"	923	1,100	1,227	1,261	1,391	1,538	1,631	1,725	1,822	1,916	2,016	2,109	2,207	2,303	2,427	2,524	2,626	2,722	2,817	2,918	2,998	3,093	
12"	1,203	1,308	1,496	1,539	1,670	1,832	1,841	1,994	2,192	2,309	2,420	2,537	2,648	2,763	2,918	3,030	3,146	3,266	3,381	3,492	3,598	3,707	
14"	1,408	1,557	1,746	1,883	2,016	2,149	2,286	2,421	2,557	2,690	2,823	2,953	3,091	3,222	3,400	3,532	3,670	3,806	3,941	4,080	4,192	4,325	
15"	1,590	1,648	1,875	2,019	2,160	2,309	2,446	2,597	2,741	2,882	3,024	3,166	3,311	3,452	3,642	3,786	3,930	4,080	4,225	4,368	4,491	4,633	
16"	1,615	1,782	1,994	2,149	2,309	2,461	2,612	2,770	2,924	3,073	3,222	3,376	3,529	3,680	3,884	4,040	4,193	4,351	4,504	4,662	4,789	4,943	
18"	1,805	1,994	2,157	2,334	2,505	2,755	2,770	2,997	3,288	3,460	3,626	3,800	3,972	4,144	4,369	4,545	4,717	4,894	5,069	5,242	5,389	5,509	
20"	2,046	2,222	2,502	2,562	2,771	3,057	3,073	3,322	3,652	3,843	4,017	4,212	4,404	4,594	4,847	5,037	5,232	5,426	5,620	5,812	5,977	6,166	
22"	2,330	2,461	2,748	2,963	3,073	3,382	3,594	3,691	3,910	4,229	4,422	4,630	4,840	5,053	5,330	5,540	5,754	5,966	6,181	6,398	6,574	6,784	
24"	2,461	2,661	2,999	3,081	3,332	3,672	3,691	3,993	4,383	4,609	4,831	5,064	5,290	5,522	5,826	6,057	6,290	6,523	6,755	6,984	7,183	7,416	
26"	2,748	2,999	3,288	3,540	3,795	3,810	4,132	4,549	4,804	4,824	5,298	5,553	5,804	6,056	6,309	6,561	6,812	7,061	7,314	7,570	8,174	8,434	
28"	2,963	3,081	3,540	3,813	3,820	4,358	4,627	4,632	5,003	5,239	5,708	5,977	6,252	6,607	6,883	7,156	7,434	7,767	7,984	8,262	8,489	8,763	
30"	3,073	3,332	3,795	3,820	4,132	4,646	4,669	5,052	5,428	5,486	6,115	6,408	6,696	6,984	7,277	7,570	7,862	8,156	8,867	9,829	9,893	9,941	
32"	3,382	3,672	3,810	4,358	4,646	4,977	5,289	5,599	5,908	6,222	6,523	6,835	7,144	7,985	8,317	8,649	8,983	9,312	10,132	10,482	10,775	11,124	
34"	3,594	3,691	4,132	4,627	4,669	5,289	5,620	5,720	6,276	6,607	6,930	7,263	8,128	8,430	8,835	9,652	10,024	10,394	10,767	11,135	11,714	11,772	
36"*	3,691	3,993	4,549	4,632	5,052	5,599	5,720	6,020	6,646	6,961	6,978	8,237	8,343	8,482	9,827	10,219	10,484	11,006	11,055	11,714	11,772	11,832	
38"*	3,910	4,383	4,804	5,003	5,428	5,908	6,276	6,646	7,018	7,911	8,298	8,692	9,433	9,843	10,372	10,789	11,204	11,619	12,031	12,446	12,795	13,209	
40"*	4,229	4,609	4,824	5,239	5,486	6,222	6,607	6,961	7,911	8,326	8,732	9,496	9,927	10,360	10,918	11,355	11,468	12,225	12,540	12,972	13,332	13,762	

SEE NEXT PAGE

\*Oversize charges will apply

# Large Cast Bronze Plaque Pricing

The table on this page shows base pricing for oversized bronze plaques. Use the information on page 254 to calculate the price for any specialty features. For questions and custom quotes, please email [Plaques@GeminiMade.com](mailto:Plaques@GeminiMade.com)



Federal Aviation Administration building entrance, Grand Rapids, Mich., cast bronze, 48" diameter.

## Large Cast Bronze Pricing\*

For included options and pricing for specialty features, see page 254

Lead-free Alloy C90300  
"Navy G"



	42"	44"	46"	48"	50"	52"	54"	56"	58"	60"	62"	64"	66"	72"	78"	84"	90"	96"
12"	\$2,420	\$2,537	\$2,648	\$2,763	\$2,918	\$3,030	\$3,146	\$3,266	\$3,381	\$3,492	\$3,598	\$3,707	\$4,202	\$4,392	\$4,583	\$5,313	\$7,434	\$7,613
18"	3,626	3,800	3,972	4,144	4,369	4,545	4,717	4,894	5,069	5,242	5,389	5,509	5,620	6,015	6,329	6,910	9,816	10,124
24"	4,831	5,064	5,290	5,522	5,826	6,057	6,290	6,523	6,755	6,984	7,183	7,416	8,555	8,959	9,510	10,948	11,351	11,759
30"	6,115	6,408	6,696	6,984	7,277	7,570	7,862	8,156	8,867	9,829	9,893	9,941	9,992	10,304	10,715	12,382	12,884	15,128
36"	6,978	8,237	8,343	8,482	9,827	10,219	10,484	11,006	11,055	11,714	11,772	11,832	11,891	12,045	13,779	15,548	16,160	16,785
40"	8,732	9,496	9,927	10,360	10,918	11,355	11,468	12,225	12,540	12,972	13,332	13,762	13,901	14,163	14,882	16,698	17,423	
42"	9,173	9,608	10,046	10,482	11,027	11,468	11,792	12,346	12,666	13,104	13,466	13,901	14,039	15,028	15,794	17,718		
44"	9,608	9,770	10,172	10,706	11,138	11,792	11,887	12,471	12,919	13,316	13,500	14,011	14,181	15,178	15,950			
46"	10,046	10,172	10,363	10,814	11,248	11,816	12,057	12,596	13,050	13,450	13,786	14,125	14,323	15,330	16,110			
48"	10,482	10,706	10,814	11,046	11,361	11,934	12,177	12,847	13,316	14,579	14,725	14,872	15,460	16,345				
52"	11,468	11,792	11,816	11,934	12,521	13,181	13,449	14,037	14,183	14,932	15,084	15,235	15,771					
54"	11,792	11,887	12,057	12,177	12,778	13,449	14,158	14,182	14,326	15,681	15,838	15,996	16,689					
56"	12,346	12,471	12,596	12,847	13,757	14,037	14,182	16,237	16,403	16,569	16,651	17,174						
60"	13,104	13,316	13,450	14,579	14,906	14,932	15,681	16,569	17,438	19,090								
64"	13,901	14,011	14,125	14,872	15,056	15,235	15,996	17,174										
66"	14,039	14,181	14,323	15,460	15,615	15,771	16,689											
72"	15,028	15,178	15,330	16,345	16,607													
78"	15,794	15,950	16,110															
84"	17,718																	

\*Oversize charges will apply

**Leave a lasting impression with stunning plaques in extended sizes!**

Need a plaque even longer than 96"? Email us for a quote!





## PhotoRelief™

Through Gemini's innovative technologies, we can use one photograph or several to create a simple and elegant plaque or a breath-taking collage that illustrates the saying, "a picture is worth a thousand words".

There are several different options available in aluminum and bronze PhotoRelief plaques. All bronze plaques are highlighted using Gemini's oxidizing technologies to bring out the contrast in the images selected. If Aluminum is selected as the base material, a two-part acrylic polyurethane paint wash is used to enhance the contrast between recessed and highlighted areas. Not available in Flash Bronze aluminum. Additional lead time needed for PhotoRelief plaques.

### Bronze PhotoRelief™

	8"	10"	12"	14"	16"	18"	20"	22"	24"
8"	\$503	\$551	\$612	\$716	\$828	\$944	\$1,014	\$1,054	\$1,059
10"	551	619	716	852	935	1,003	1,059	1,064	1,269
12"	612	716	879	968	1,138	1,139	1,269	1,387	1,512
14"	716	852	968	1,032	1,184	1,334	1,478	1,798	1,808
16"	828	935	1,138	1,184	1,346	1,510	1,710	2,057	2,068
18"	944	1,003	1,139	1,334	1,510	1,733	1,929	2,306	2,317
20"	1,014	1,059	1,269	1,478	1,710	1,929	2,141	2,564	2,578
22"	1,054	1,064	1,387	1,798	2,057	2,306	2,564	2,908	3,077
24"	1,059	1,269	1,512	1,808	2,068	2,317	2,578	3,077	3,093
26"	1,228	1,539	1,873	2,185	2,498	2,657	3,125	3,437	3,747
28"	1,303	1,576	1,929	2,356	2,691	2,698	3,201	3,701	3,849
30"	1,308	1,607	1,939	2,522	2,883	2,897	3,216	3,839	3,868
32"	1,512	1,924	2,306	2,691	3,077	3,460	3,839	4,226	4,608
34"	1,547	2,043	2,317	2,864	3,264	3,477	3,859	4,494	4,631
36"*	1,563	2,160	2,329	3,024	3,460	3,494	3,877	4,608	4,642

\*Oversize charges will apply

### Aluminum PhotoRelief™

	8"	10"	12"	14"	16"	18"	20"	22"	24"
8"	\$302	\$330	\$364	\$426	\$459	\$528	\$564	\$587	\$594
10"	330	370	426	473	522	560	591	593	711
12"	364	426	489	541	636	640	711	775	846
14"	426	473	541	575	659	743	821	1,002	1,007
16"	459	522	636	659	748	839	952	1,148	1,154
18"	528	560	640	743	839	970	1,076	1,286	1,292
20"	564	591	711	821	952	1,076	1,196	1,428	1,436
22"	587	593	775	1,002	1,148	1,286	1,428	1,621	1,715
24"	594	711	846	1,007	1,154	1,292	1,436	1,715	1,723
26"	684	855	1,046	1,218	1,395	1,505	1,742	1,914	2,089
28"	726	881	1,076	1,312	1,502	1,512	1,786	2,063	2,146
30"	730	895	1,082	1,408	1,607	1,610	1,796	2,140	2,157
32"	846	1,072	1,286	1,502	1,715	1,916	2,140	2,359	2,570
34"	865	1,141	1,292	1,594	1,821	1,935	2,151	2,502	2,583
36"*	870	1,200	1,299	1,684	1,925	1,944	2,161	2,570	2,596

\*Oversize charges will apply

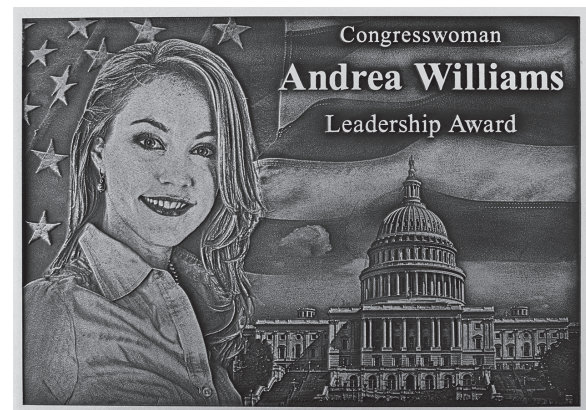

# Cast Aluminum Plaque Pricing

The tables on these pages show base pricing for our cast aluminum plaques. Use the information below to calculate the price for any specialty features. For questions and custom quotes, please email [Plaques@GeminiMade.com](mailto:Plaques@GeminiMade.com)



**TrueQuote!**  
Online price calculator

GeminiSignage.com

## Included With Your Order

- Custom Size & Shape
- Standard Border & Brushed Finish
- One Standard Background/Edge Color
- One Artwork Proof
- Appropriate Packaging

## Additional Options

- Garden Stake Mount
  - 24" stake = \$104
  - 36" stake = \$122
  - 48" stake = \$144
- Post Mount
  - 1" x 6' = \$170
  - 1" x 8' = \$227
  - 1.5" x 6' = \$221
  - 1.5" x 8' = \$294
  - 2" x 6' = \$255
  - 2" x 8' = \$340
- Mounting Patterns
  - Up to 12" = \$19
  - 13" - 23" = \$39
  - 24"+ = \$59
- Custom Border \$58
- Up to 2 additional paint colors \$92/color
- Buffed Face +50%
- Buffed Bevel Edge +20%

## Cast Aluminum Pricing

	2"	3"	4"	5"	6"	7"	8"	9"	10"	12"	14"	15"	16"	18"	20"
2"	\$111	\$111	\$111	\$111	\$111	\$111	\$111	\$111	\$111	\$111	\$123	\$130	\$131	\$137	\$150
3"	111	111	111	111	111	111	111	120	128	137	205	214	216	236	257
4"	111	111	111	111	111	123	131	134	150	174	206	216	217	237	258
5"	111	111	111	111	128	134	150	157	178	212	281	306	307	308	333
6"	111	111	111	128	134	174	175	199	212	258	282	308	311	312	334
7"	111	111	123	134	174	213	214	217	257	278	351	355	356	406	436
8"	111	111	131	150	175	214	216	236	258	280	352	356	357	408	439
9"	111	120	134	157	199	217	236	259	287	314	366	394	421	459	489
10"	111	128	150	178	212	257	258	287	290	349	369	396	423	461	503
12"	111	137	174	212	258	278	280	314	349	404	444	464	505	541	605
14"	123	205	206	281	282	351	352	366	369	444	504	543	561	634	720
15"	130	214	216	306	308	355	356	394	396	464	543	592	619	693	775
16"	131	216	217	307	311	356	357	421	423	505	561	619	656	737	814
18"	137	236	237	308	312	406	408	459	461	541	634	693	737	824	915
20"	150	257	258	333	334	436	439	489	503	605	720	775	814	915	1,017
22"	281	281	283	410	413	452	454	490	530	679	773	890	895	995	1,134
24"	282	283	284	454	457	483	485	534	605	739	855	946	973	1,126	1,251
26"	407	413	415	471	476	496	542	637	679	829	966	1,080	1,103	1,213	1,434
28"	409	415	419	473	477	534	577	686	694	853	1,039	1,164	1,186	1,317	1,470
30"	410	416	421	476	478	572	618	730	762	915	1,112	1,246	1,298	1,413	1,564
32"	414	417	423	503	505	611	671	786	849	1,016	1,186	1,329	1,387	1,589	1,767
34"	483	485	488	507	522	650	685	834	905	1,021	1,263	1,411	1,472	1,597	1,775
36"	483	485	488	509	543	685	735	881	953	1,092	1,362	1,494	1,557	1,689	1,875
38"	515	517	520	522	597	724	788	932	1,008	1,210	1,548	1,581	1,646	1,885	2,094
40"	539	542	545	547	627	763	849	995	1,060	1,298	1,557	1,660	1,734	1,982	2,205

\*Oversize charges will apply

**How to Use These Tables**

Prices shown are for one plaque with a brushed finish, standard border and background color. For special sizes not shown, use the next largest plaque price. For example, a 17" x 30" plaque would be priced as 18" x 30". For duplicate cast plaques on a single order (up to 40" x 64" maximum size) email for review on pricing.



**Pricing Example**

- 30" x 17"
- Price as 30" x 18"

\$1,413 list price



Alloy #356



Flash Bronze (+15%)  
Interior Applications Only

**STANDARD DEPTHS:**

- Less than 324 sq. inches = 5/16" Depth
- 324 - 575 sq. inches = 1/2" Depth
- 576 - 1,295 sq. inches = 3/4" Depth
- Over 1,295 sq. inches = 1" Depth

	22"	24"	26"	28"	30"	32"	34"	36"*	38"*	40"*	42"*	44"*	46"*	48"*	50"*	52"*	54"*	56"*	58"*	60"*	62"*	64"*	>64"
2"	\$281	\$282	\$407	\$409	\$410	\$414	\$483	\$483	\$515	\$539	\$571	\$596	\$624	\$652	\$665	\$737	\$776	\$827	\$865	\$921	\$951	\$982	
3"	281	283	413	415	416	417	485	485	517	542	574	598	627	655	681	753	780	851	890	939	965	996	
4"	283	284	415	419	421	423	488	488	520	545	577	602	630	659	753	781	799	862	924	946	976	1,004	
5"	410	454	471	473	476	503	507	509	522	547	579	605	634	662	779	794	807	908	944	982	1,015	1,045	
6"	413	457	476	477	478	505	522	543	597	627	662	691	720	757	831	863	890	943	976	1,008	1,041	1,073	
7"	452	483	496	534	572	611	650	685	724	763	818	855	893	935	982	1,020	1,060	1,101	1,136	1,177	1,215	1,251	
8"	454	485	542	577	618	671	685	735	788	849	895	938	982	1,022	1,122	1,166	1,212	1,254	1,301	1,345	1,386	1,431	
9"	490	534	637	686	730	786	834	881	932	995	1,054	1,102	1,152	1,202	1,260	1,308	1,360	1,411	1,461	1,510	1,559	1,609	
10"	530	605	679	694	762	849	905	953	1,008	1,060	1,117	1,172	1,224	1,303	1,400	1,457	1,510	1,565	1,622	1,679	1,731	1,786	
12"	679	739	829	853	915	1,016	1,021	1,092	1,210	1,298	1,368	1,432	1,499	1,562	1,679	1,746	1,772	1,881	1,949	2,009	2,077	2,144	
14"	773	855	966	1,039	1,112	1,186	1,263	1,362	1,548	1,557	1,595	1,671	1,747	1,824	1,960	2,039	2,115	2,194	2,273	2,352	2,422	2,502	
15"	890	946	1,080	1,164	1,246	1,329	1,411	1,494	1,581	1,660	1,749	1,832	1,918	1,998	2,099	2,183	2,267	2,350	2,432	2,519	2,594	2,678	
16"	895	973	1,103	1,186	1,298	1,387	1,472	1,557	1,646	1,734	1,824	1,914	1,994	2,081	2,240	2,327	2,416	2,505	2,594	2,684	2,767	2,856	
18"	995	1,126	1,213	1,317	1,413	1,589	1,597	1,689	1,885	1,982	2,090	2,190	2,290	2,388	2,519	2,621	2,712	2,821	2,922	3,023	3,115	3,188	
20"	1,134	1,251	1,434	1,470	1,564	1,767	1,775	1,875	2,094	2,205	2,322	2,434	2,543	2,652	2,798	2,911	3,023	3,133	3,246	3,357	3,460	3,572	
22"	1,311	1,414	1,577	1,701	1,767	1,939	2,063	2,116	2,243	2,426	2,556	2,676	2,797	2,919	3,077	3,203	3,325	3,448	3,569	3,694	3,809	3,930	
24"	1,414	1,503	1,721	1,768	1,876	2,116	2,127	2,253	2,513	2,646	2,785	2,919	3,054	3,184	3,357	3,491	3,612	3,757	3,894	4,029	4,153	4,288	
26"	1,577	1,721	1,883	2,030	2,176	2,183	2,260	2,608	2,751	2,767	3,042	3,188	3,333	3,477	3,636	3,783	3,928	4,073	4,218	4,364	4,497	4,643	
28"	1,701	1,768	2,030	2,184	2,190	2,498	2,652	2,658	2,761	2,778	3,275	3,430	3,587	3,744	3,919	4,073	4,232	4,385	4,541	4,699	4,844	5,002	
30"	1,767	1,876	2,176	2,190	2,328	2,676	2,678	2,766	3,114	3,149	3,511	3,676	3,845	4,010	4,197	4,363	4,513	4,699	4,865	5,395	5,562	5,742	
32"	1,939	2,116	2,183	2,498	2,676	2,855	3,031	3,212	3,387	3,567	3,744	3,923	4,100	4,585	4,795	4,988	5,177	5,368	5,562	5,752	5,949	5,979	
34"	2,063	2,127	2,260	2,652	2,678	3,031	3,221	3,281	3,600	3,787	3,977	4,168	4,668	4,844	5,095	5,300	5,502	5,706	5,907	6,195	6,210	6,226	
36"*	2,116	2,253	2,608	2,658	2,766	3,212	3,281	3,329	3,813	3,993	4,003	4,728	4,788	4,869	5,395	5,608	5,803	6,040	6,191	6,254	6,285	6,317	
38"*	2,243	2,513	2,751	2,761	3,114	3,387	3,600	3,813	4,022	4,535	4,766	4,990	5,215	5,444	5,690	5,919	6,148	6,374	6,605	6,829	7,045	7,273	
40"*	2,426	2,646	2,767	2,778	3,149	3,567	3,787	3,993	4,535	4,774	5,014	5,251	5,490	5,727	5,990	6,233	6,472	6,713	6,951	7,191	7,416	7,652	

SEE NEXT PAGE

\*Oversize charges will apply



# Large Cast Aluminum Plaque Pricing

The table on this page shows base pricing for oversized cast aluminum plaques. For questions and custom quotes, please email [Plaques@GeminiMade.com](mailto:Plaques@GeminiMade.com).



LARGO HIGH SCHOOL,  
cast aluminum, 96" diameter  
with multi-color paint



Alloy #356

## Large Cast Aluminum Pricing\* For included options and pricing for specialty features, see page 258.

	42"	44"	46"	48"	50"	52"	54"	56"	58"	60"	62"	64"	66"	72"	78"	84"	90"	96"
12"	\$1,368	\$1,432	\$1,499	\$1,562	\$1,679	\$1,746	\$1,772	\$1,881	\$1,949	\$2,009	\$2,077	\$2,144	\$2,856	\$2,915	\$2,966	\$3,604	\$5,693	\$5,744
18"	2,090	2,190	2,290	2,388	2,519	2,621	2,712	2,821	2,922	3,023	3,115	3,188	3,203	3,354	3,559	4,005	6,755	6,855
24"	2,785	2,919	3,054	3,184	3,357	3,491	3,612	3,757	3,894	4,029	4,153	4,288	5,556	5,680	5,942	7,117	7,244	7,382
30"	3,511	3,676	3,845	4,010	4,197	4,363	4,513	4,699	4,865	5,395	5,562	5,742	5,904	6,068	6,229	7,568	7,731	9,657
36"	4,003	4,728	4,788	4,869	5,395	5,608	5,803	6,040	6,191	6,254	6,285	6,317	6,348	6,654	8,417	9,793	9,980	10,182
40"	5,014	5,251	5,490	5,727	5,990	6,233	6,472	6,713	6,951	7,191	7,416	7,652	8,284	8,505	8,738	10,123	10,343	10,576
42"	5,251	5,490	5,727	5,919	6,382	6,511	6,684	7,123	7,267	7,416	8,135	8,284	8,454	8,680	8,920	10,330	10,555	10,793
44"	5,490	5,849	6,099	6,278	6,619	6,755	6,824	7,847	8,259	8,385	8,469	8,495	8,642	8,900	8,984	10,367	10,833	11,106
46"	5,727	6,099	6,458	6,637	6,687	6,824	6,963	7,926	8,364	8,471	8,553	8,608	8,730	8,990	9,077	10,472	10,944	11,378
48"	5,919	6,278	6,637	6,812	6,856	6,890	7,076	8,385	8,470	8,555	8,640	8,679	8,818	9,079	9,168	10,576	11,055	11,649
52"	6,511	6,755	6,824	6,890	8,077	8,240	8,324	8,528	8,616	8,641	8,817	8,900	8,995	9,197	9,487	10,917	13,502	13,781
54"	6,684	6,824	6,963	7,076	8,155	8,324	8,547	8,794	8,836	8,880	9,042	9,089	9,180	10,137	10,458	11,257	13,919	14,208
56"	7,123	7,847	7,926	8,385	8,441	8,528	8,794	11,339	11,395	11,452	11,670	11,696	11,788	12,111	12,442	12,777	14,028	14,608
60"	7,416	8,385	8,471	8,555	8,574	8,641	8,880	11,452	11,530	11,570	11,727	11,788	11,904	12,232	12,567	12,907	14,170	14,757
64"	8,284	8,495	8,608	8,679	8,726	8,900	9,089	11,696	11,728	11,788	12,024	12,145	12,206	12,517	12,877	13,237	14,247	
66"	8,454	8,642	8,730	8,818	8,906	8,995	9,180	11,788	11,845	11,904	12,084	12,206	12,269	12,646	13,008	14,291		
72"	8,680	8,900	8,990	9,079	9,150	9,197	10,137	12,111	12,172	12,232	12,455	12,517	12,646	13,008	14,373			
78"	8,920	8,984	9,077	9,168	9,299	9,487	10,458	12,442	12,504	12,567	12,814	12,877	13,008	14,373				
84"	10,330	10,367	10,472	10,576	10,698	10,917	11,257	12,777	12,843	12,907	13,103	13,237	14,291					
90"	10,555	10,833	10,944	11,055	13,232	13,502	13,919	14,028	14,098	14,170	14,176	14,247						
96"	10,793	11,106	11,378	11,649	13,504	13,781	14,208	14,608	14,683	14,757								

\*Oversize charges will apply

**Leave a lasting impression with stunning plaques in extended sizes!**

Need a plaque even longer than 96"? Email [Plaques@GeminiMade.com](mailto:Plaques@GeminiMade.com)

## Seals & Circular Plaques

The tables on this page feature pricing for the most common military and government designs in bronze and aluminum, and standard pricing for circular plaques. Other seals not shown can be manufactured for additional costs. Email for quote. Multi-color seals can also be produced in 16" - 40" sizes with an additional charge. For questions and custom quotes, please email [Plaques@GeminiMade.com](mailto:Plaques@GeminiMade.com)



Sculpted Relief

### CIRCULAR PLAQUES

DIAMETER	BRONZE	ALUMINUM
5"	\$185	\$125
6"	212	151
8"	317	244
10"	443	312
12"	535	382
14"	650	412
16"	771	502
18"	1,056	686
20"	1,374	884
22"	1,512	973
24"	1,877	1,212
28"	2,361	1,514
30"	2,936	1,894
36"*	4,220	2,723
42"*	5,754	3,707
48"*	7,520	4,837
54"*	13,232	8,295
60"*	14,927	8,872
66"*	19,189	11,611
72"*	21,172	12,186
78"*	23,290	13,141
84"*	26,334	14,456
90"*	28,843	15,245
96"*	31,624	16,163

\*Oversize charges will apply

### GOVERNMENT SEALS

DIAMETER	DEPTH	FLAT RELIEF		SCULPTED RELIEF	
		BRONZE	ALUMINUM	BRONZE	ALUMINUM
10"	5/16"	\$445	\$327	NA	NA
12"	5/16"	535	374	NA	NA
14"	5/16"	650	398	NA	NA
16"	5/16"	766	489	\$1,008	\$647
18"	1/2"	1,051	666	1,383	883
24"	3/4"	1,853	1,175	2,438	1,559
30"	3/4"	2,900	1,840	3,817	2,442
36"*	1"	4,168	2,643	5,486	3,511
40"*	1"	5,144	3,262	6,772	4,332
48"*	1"	7,426	4,695	9,781	6,237
60"*	1"	14,593	8,611	NA	NA
72"*	1"	20,696	12,118	NA	NA
84"*	1"	25,739	14,027	NA	NA
96"*	1"	30,911	15,687	NA	NA

\*Oversize charges will apply



Flat Relief

#### CAST GOVERNMENT SEALS INCLUDE:

- Army
- Navy
- Marines
- Air Force
- Coast Guard
- Merchant Marines
- Department of Homeland Security
- POW / MIA
- Department of Veterans Affairs
- Space Force

#### GOVERNMENT SEALS

When you order government seals from Gemini, we are of the understanding that you have all the required rights in place for us to produce your project as requested.





## UV Printing

For use in wayfinding where Braille or raised copy is not required, these panels have your 1200 dpi full-color image printed on aluminum, brass, bronze or stainless steel — simply choose your material, thickness and shape, and supply a high-quality image. Gemini warrants these products for interior use, although they will last under most moderate weathering conditions. Email [Plaques@GeminiMade.com](mailto:Plaques@GeminiMade.com) for quote.

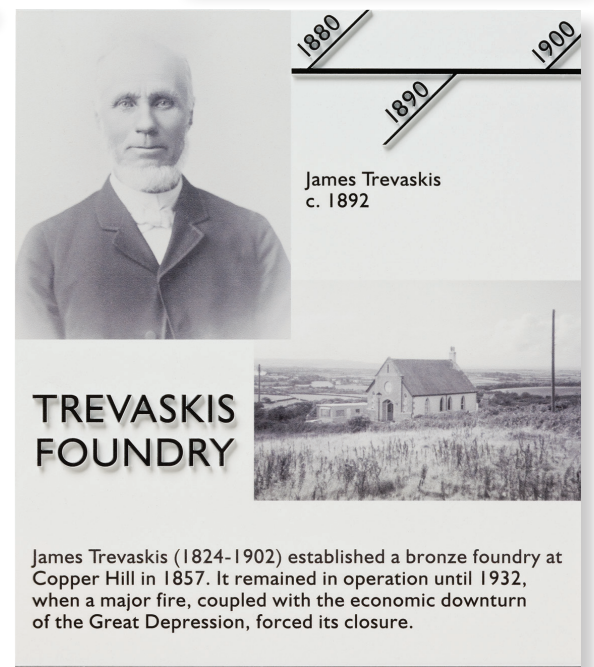
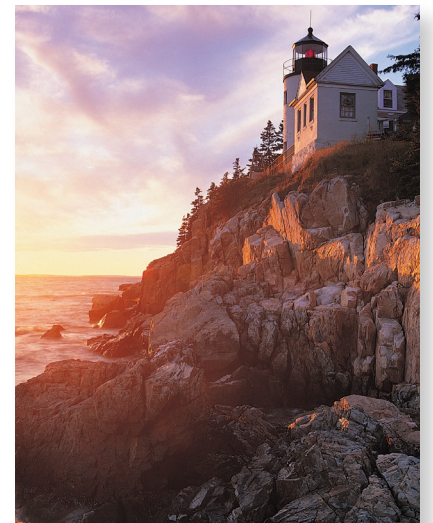
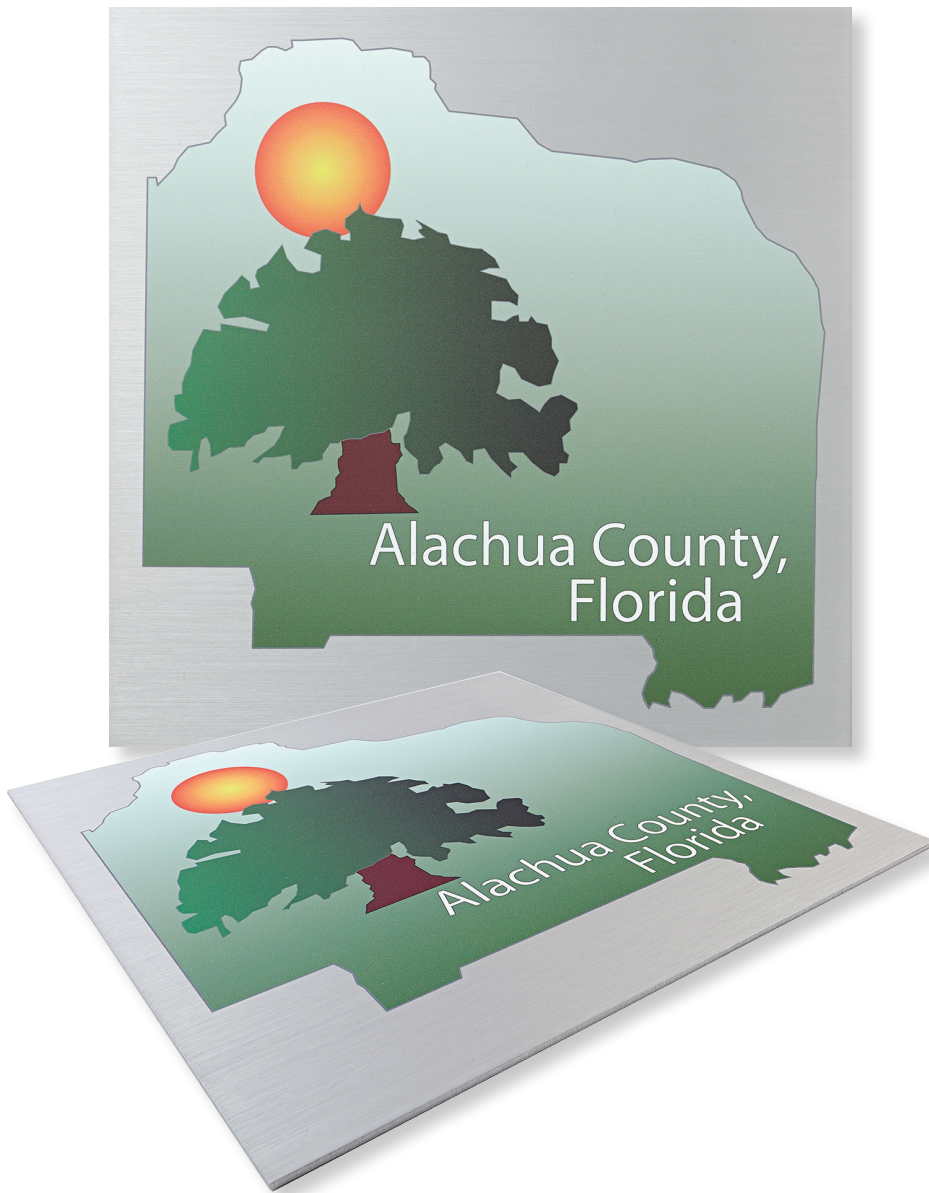



## Custom ADA Plaques

A truly custom product should not be placed in a cookie cutter shape. Gemini gives you the option to design not only the image and color of your ADA solutions, but also the overall shape of the individual plaques. Even within ADA constraints, Gemini's custom capabilities provide a flexible array of design possibilities. We welcome your custom designs for different colors, patterns, sizes and special features that can all be combined to create room identification signs that are functional and compliant, while coordinating attractively with interior finishes. ADA plaques can be priced using the Precision Tooled pricing or email [Plaques@GeminiMade.com](mailto:Plaques@GeminiMade.com) for quote.



## Standard ADA Plaques

Gemini ADA directional signage offers beauty, style and compliance. Plaques are available in the standard 7" x 8.5" x 0.25" size and design, with a stipple or sand background, or in your own custom design. Don't let ADA signage requirements be an eyesore — order solid aluminum, bronze and brass ADA-compliant plaques from Gemini. Unlike other ADA-compliant products, Gemini's patent-pending process does not use loose beads for the Braille component or rely on imperfect, non-compliant castings.

SIZE	ALUMINUM	BRONZE	BRASS
7" x 8.5" x .25"	\$145	\$277	\$277

For indoor applications, double face tape can be substituted at no additional charge.

California ADA also available. Email for a quote.

ADA: stipple or sand backgrounds only

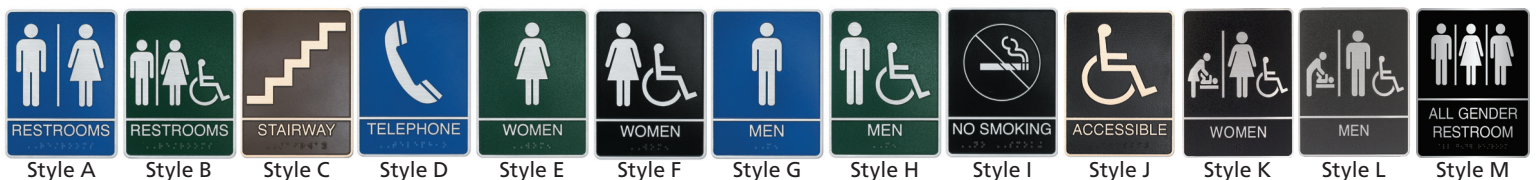

# Beveled Edge Plaque Frames

Enhance any Gemini plaque or your own 1/8" thick plaque or panel with our plaque frames. These frames come in 14 common sizes. Frames are stocked in white and available in any standard baked enamel color. We use CAB (cellulose acetate butyrate) plastic, a non-petroleum-based plastic that is a renewable resource, as the base material. Suitable for interior or exterior use. Recommend adhesive or D/F tape to affix plaque or engraving plate to frame.

**NEW! Need a finished engraved or sublimated sign?**

Email: [Plaques@GeminiMade.com](mailto:Plaques@GeminiMade.com)

Frame Size	Engraving Plate Size	Frame Only	Frame With Ultrablack Engraving Plate	Frame With Duraluxe Sublimation Plate
3" x 9"	2" x 8"	\$12.60	\$15.78	\$17.38
3" x 11"	2" x 10"	12.70	16.67	18.87
4" x 5"	3" x 4"	11.40	13.78	15.10
5" x 5"	4" x 4"	12.60	15.78	17.55
5" x 7"	4" x 6"	12.90	17.65	20.30
5" x 9"	4" x 8"	19.10	23.85	28.97
5" x 11"	4" x 10"	23.00	30.93	35.35
7" x 7"	6" x 6"	15.50	22.60	26.62
7" x 9"	6" x 8"	20.10	29.63	34.92
7" x 11"	6" x 10"	27.50	39.40	46.02
7" x 13"	6" x 12"	29.70	43.60	51.30
9" x 9"	8" x 8"	25.70	38.38	45.45
11" x 13"	10" x 12"	32.00	69.72	80.88
13" x 13"	12" x 12"	42.00	70.57	86.43



Quantity discounts available. Email for more information.



## Cast Aluminum Plaque Blanks

Aluminum plaques with raised double border and recessed area to accommodate an engraving plate (available separately), cast by Gemini and ready to ship within days. Available with integral bracket for rod mount or with through-hole mount (including screws), they are manufactured in four different sizes. These plaques are a low-cost option to satisfy customers that require an all-metal plaque.

Our blanks are cast with aluminum alloy 356, painted and baked, then sealed with acrylic polyurethane.

Flash Bronze not recommended for exterior use.

## Plaque Blanks

Color	Outside Dimension	Plate Area	Blank Only	Blank with Ultrablack Engraving Plate	Blank with Duraluxe Sublimation Plate	With 24" Rod	With 24" Rod and Ultrablack Engraving Plate	With 24" Rod and Duraluxe Engraving Plate
Brushed Aluminum and Black	3" x 9"	2" x 8"	\$36.00	\$39.18	\$40.95	N/A	N/A	N/A
	4" x 6"	3" x 5"	32.00	34.97	36.63	42.00	44.97	46.63
	6" x 8"	5" x 7"	58.00	64.94	68.82	69.00	75.94	79.82
	8" x 10"	7" x 9"	99.00	111.50	118.43	106.00	118.50	125.43
Flash Bronze and Brown	3" x 9"	2" x 8"	44.00	47.18	48.95	N/A	N/A	N/A
	4" x 6"	3" x 5"	40.00	42.97	44.63	51.00	53.97	55.63
	6" x 8"	5" x 7"	80.00	86.94	90.82	90.00	96.94	100.82
	8" x 10"	7" x 9"	124.00	136.50	143.43	135.00	147.50	154.43

\*3/8" diameter, aluminum rod for mounting Flat, Cast Aluminum, Double Line Border, with through holes or optional aluminum rods. Ships in 2-3 work days.



## 46 Standard Painted Colors

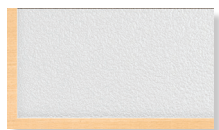

White 5687

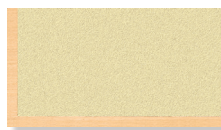

Ivory – 2718

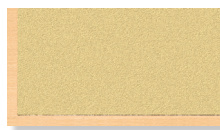

Desert Sand - 4660



Grey – 0209

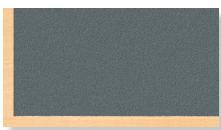

Dove Grey – 4310



Safety Green – 8090



Lemon Yellow – 2037



Yellow – 2000



Citrus Yellow 0217



Sundance Yellow 0218



Mango – 0254



Orange – 2119



Red-Orange – 2662



Rampart Orange – 0256



Red – 2793



Brick Red – 1875



Black Cherry – 2280



Maroon – 2240



Magenta – 2410



Purple – 2287



Violet Toner – 0246

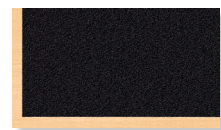

Midnight Blue - 2767



Dark Blue - 2050



Medium Blue – 2860



Blue – 3000



Light Blue – 2648

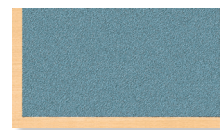

Marine Reef Blue – 5425



Teal Blue – 3210



Spring Green – 3555



Emerald Green



Federal Green – 0259



Light Green – 2108



Dark Green – 2030

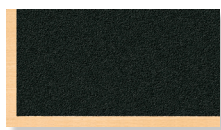

Hunter Green – 2162



Brilliant Gold – 0400



Metallic Gold – 2756



Aztec Gold – 0401



Copper – 0253



Aztec Copper – 0402

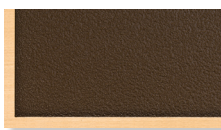

Brown – 2418



Medium Bronze – 0312



Old Copper – 0314

Satin finish is standard.  
Custom paint matching is available.



Duranodic Bronze– 3130



Dark Oxide – 1315



Metallic Silver – 8886



Black – 2025



# THE BLAKE SCHOOL 1900

Through the leadership of the Board of Trustees, the inspired creative vision of James Dayton, the heartening generosity of parents, alumni, and friends, and, because of the extraordinary duo of Beth Hower and Julie Yang, who kept us focused on our students — the completion of Highercroft's expansion and renovation has become a reality. To all who were involved in this project, I thank you on behalf of all Blake students and their parents, both those enjoying the fruits of this project today and those who will enjoy this new building in the generations to come.

John C. Gulla, Head of School  
Celebration of Gratitude  
September 28, 2006

#### *Benefactors*

Curtis L. Carlson Family Foundation  
Sage & John Cowles  
Michael Crosby & Lisa DeJoras  
Bob & Joanie Dayton  
James G. & Megan M. Dayton  
Scott & Ann Dayton  
Toby & Mac Dayton  
Kevin & Sara McCary  
The Subes Family Foundation

#### *Partners*

Kent & Mandy Adams  
Bruce & Martha Atwater  
Sarah Bishop & John Mailhiot  
Tim & Beth Bishop  
Michael J. Blum & Abigail Rose  
Brad & Serena Bowman  
David & Anna Bull  
Forrest & Renee Burke  
M. Nicholas Burke & Susan Slattery Burke  
Patrick & Kirsten Burton  
Paul & Liza Cameron  
Carolyn Foundation  
David & Kitty Crosby  
Judson & Aleya Champin  
Gregory Cunningham & Jacqueline Lloyd Cunningham  
Sandy & Debbie Donaldson  
Craig & Rebecca Ellis  
David & Joan Floren  
David & Kristine Gigerich  
Jane August Gleeson  
Keith Halperin & Karen Grabow  
Greystone Foundation  
Walt McCarthy & Clara Ueland  
John Gulla & Andrea Godbout  
Larry & Emmie Hester  
Michael & Susan Horowitz  
Beth S. & George H. Hower  
Andrew & Alison Humphrey  
Robert & Amy Isom  
Michael & Mary Kehler  
Michael & Kathy Kenler  
Sarah & John Lindahl  
Tom & Kathy Martin  
Mary & Tom McCary Family Foundation  
Bill & Martha McLaughlin  
Doug & Theresa Moore  
Curtis & Marjorie Nelson  
Robin B. Nelson  
John & Joan Nolan  
Jed & Debbie Norgaarden  
OSilas Foundation  
David & Margaret Ford  
Mr. & Mrs. Silas M. Ford III  
Dr. Robert Werling & Kimberly Ford  
John & Susan Palombo  
Greta R. Poffcher  
Janet & Gunnar Johnson  
Mimi & Ben Rae  
Norm Rickeman & Kathy Murphy  
Dr. Kayven & Paula Riggi  
Mark & Becky Roloff  
John & Peggy Scholz  
Andrea M. Sievert  
P. Eric Sievert  
Barbara H. Steiner  
Brian & Carolyn Taylor  
Mary MacPhail Taylor & Jack Taylor  
Ten Times Ten Foundation  
Charles B. Hartwell &  
Robin Taylor Hartwell  
Tim & Elisabeth Truff  
Nina Bishop Tuttle & John Tuttle  
Chris & Serene Warren  
David & Elizabeth Weyerhueser  
William & Karen Whitely  
Jamie Wilson & David Ericson  
Mike & Penny Winton  
Rafus & Elizabeth Winton

All Highercroft Faculty & Staff  
past, present, & future

## VERSATILE AND ELEGANT

With etched metal plaques from Gemini, you can easily produce custom signage in distinctive metals from original artwork, with nearly limitless possibilities and detail. Common applications include interior and exterior wayfinding, brand and identity signage, awards, and recognition plaques.

1.877.877.2922





# ETCHED PLAQUES

Reproduce complex  
art on metal

Stainless steel,  
bronze, brass &  
aluminum

4 material thicknesses  
to choose from

Sizes up to 36" x 72"

## PRECISION DETAIL, ARTISTIC FREEDOM

Gemini's chemical etching is a proprietary process that allows us to transfer your most complex artwork to a brass, bronze or stainless-steel surface. Your text and the most fine-detailed line-art graphics are surface etched with incredible results, producing a recessed area of the material surface that is paint-filled with your choice of colors. Etched photos are created with halftone images, which resemble newspaper photographs with visible dot patterns. The dots are filled with black paint to contrast with the brushed metal finish.

### WHEN ORDERING

PLEASE SPECIFY:

- Artwork & Critical Dimensions
- Material & Thickness
- Paint Fill Color
- Finish Selection
- Mounting Method



## SIGNAGE ETCHED INTO EXPERIENCES

### Alloys:

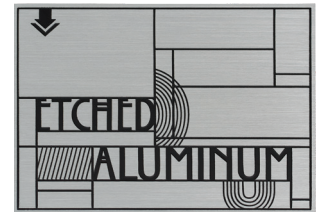
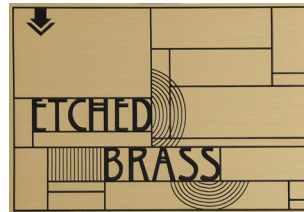
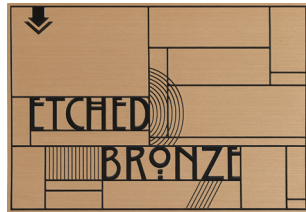
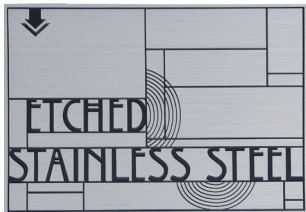

### Most Common Background Colors:



Black - 2025

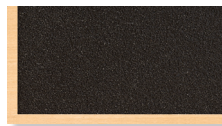

Dark Oxide - 1315



Brown - F63R



Duranodic Bronze - 3130



Image of welded boss

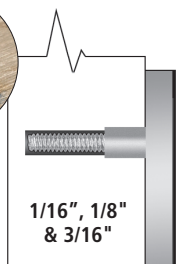

(welded stud boss)

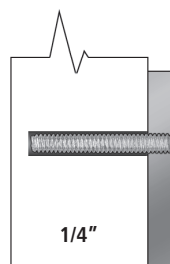

(drilled & tapped)

Blind Stud Mount

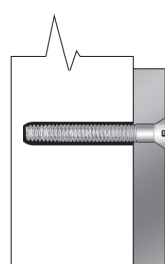

Through-hole Mount

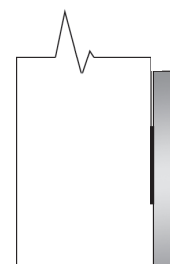

Double Face Tape

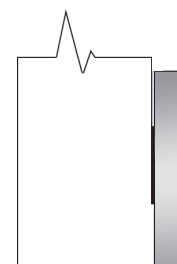

Plain



### Raised or Recessed Graphics:

The standard on all Gemini etched plaques is recessed text and graphics that are paint-filled. Raised text or graphics means the background will be painted, leaving the text or graphics in the alloy color. (There are stroke and artwork limitations with raised graphics.)



**Recessed Graphics  
(Standard)**



**Raised Graphics  
(Optional +10%)**

### Edges:



**SQUARE EDGE (STANDARD):**  
The standard edge on an etched plaque is a straight edge (90°).



**BEVEL EDGE (+10%):**  
A 41° bevel is applied to the edge at one-half the material thickness. Bevel edges are not available on 1/16" thick material.



Edge color matches fill color.

### LINE ART & PHOTOGRAPHY:

A sketch or drawing can be etched with fabulous results by reproducing a black and white line drawing. Since no halftone screen is used in the process, the fine lines are expertly captured in exquisite detail. (Please email for a quote.) Etched photos are created with halftone images, which resemble newspaper photographs and have visible dot patterns. The dots are filled with black paint to contrast with the brushed metal finish. High contrast photographs work best for etched images up to 24" x 24".

# Etched Stainless Steel and Aluminum

The tables on these pages show base pricing for our etched plaques. Pricing includes a brushed finish and single-color fill. For questions, larger sizes or custom finishes, please email [Plaques@GeminiMade.com](mailto:Plaques@GeminiMade.com)

## 1/16" STAINLESS STEEL or ALUMINUM

SIZE	2"	3"	4"	5"	6"	7"	8"	9"	10"	11"	12"	14"	15"	16"	18"	20"	22"	24"
2"	\$111	\$111	\$111	\$111	\$111	\$111	\$111	\$111	\$111	\$111	\$111	\$142	\$152	\$162	\$182	\$203	\$223	\$223
3"	111	111	111	111	111	111	111	137	152	167	182	213	228	228	243	249	274	299
4"	111	111	111	111	111	142	162	182	203	223	243	243	249	266	299	299	333	359
5"	111	111	111	127	152	177	203	225	228	229	249	291	312	333	333	346	353	385
6"	111	111	111	152	182	213	233	243	249	274	299	349	365	374	374	385	423	462
7"	111	111	142	177	213	233	233	262	291	320	349	359	365	374	404	449	494	
8"	111	111	162	203	233	233	266	299	333	345	350	375	385	411	462			
9"	111	137	182	225	243	262	299	337	337	353	374	404	433	462				
10"	111	152	203	228	249	291	333	337	337	353	385	449	481					
11"	111	167	223	229	274	320	345	353	353	388	423	494						
12"	111	182	243	249	299	349	350	374	385	423	462							
14"	142	213	243	291	349	359	375	404	449	494								
15"	152	228	249	312	365	365	385	433	481									
16"	162	228	266	333	374	374	411	462										
18"	182	243	299	333	374	404	462											

Recommend 1/8" or 1/4" thick material

For larger plaques please email for quote.

## 1/8" STAINLESS STEEL or ALUMINUM   = Stainless Steel Only

SIZE	2"	3"	4"	5"	6"	7"	8"	9"	10"	11"	12"	14"	15"	16"	18"	20"	22"	24"
2"	\$117	\$117	\$117	\$117	\$117	\$117	\$117	\$117	\$117	\$117	\$117	\$152	\$163	\$174	\$195	\$217	\$239	\$260
3"	117	117	117	117	117	117	117	147	163	179	195	228	244	260	260	285	314	342
4"	117	117	117	117	117	152	174	195	217	239	260	266	285	304	342	380	392	405
5"	117	117	117	136	163	190	217	244	244	261	285	333	356	380	385	390	392	428
6"	117	117	117	163	195	228	260	260	285	314	342	399	428	435	440	465	470	513
7"	117	117	152	190	228	266	266	299	333	366	399	415	428	435	449	499	549	599
8"	117	117	174	217	260	266	304	342	380	418	418	420	428	456	513	570	627	635
9"	117	147	195	244	260	299	342	385	385	427	430	449	481	513	577	577	635	693
10"	117	163	217	244	285	333	380	385	390	430	430	499	535	570	577	642	706	770
11"	117	179	239	261	314	366	418	427	430	431	470	549	575	610	635	706	776	847
12"	117	195	260	285	342	399	418	430	430	470	513	599	605	616	693	770	847	924
14"	152	228	266	333	399	415	420	449	499	549	599	629	674	719	808	898	988	1,078
15"	163	244	285	356	428	428	428	481	535	575	605	674	722	770	866	962	1,059	1,155
16"	174	260	304	380	435	435	456	513	570	610	616	719	770	821	924	1,026	1,129	1,232
18"	195	260	342	385	440	449	513	577	577	635	693	808	866	924	1,039	1,155	1,270	1,386

For larger plaques please email for quote.

## 3/16" STAINLESS STEEL or ALUMINUM

SIZE	2"	3"	4"	5"	6"	7"	8"	9"	10"	11"	12"	14"	15"	16"	18"	20"	22"	24"
2"	\$121	\$121	\$121	\$121	\$121	\$121	\$121	\$121	\$121	\$121	\$121	\$159	\$170	\$181	\$204	\$227	\$249	\$272
3"	121	121	121	121	121	121	121	153	170	187	204	238	255	272	289	299	329	359
4"	121	121	121	121	121	159	181	204	227	249	272	279	299	319	359	407	439	449
5"	121	121	121	142	170	198	227	255	269	274	299	349	374	399	415	425	440	470
6"	121	121	121	170	204	238	272	279	299	329	359	419	439	459	465	470	517	565
7"	121	121	159	198	238	278	279	314	349	384	419	459	464	469	494	549	604	659
8"	121	121	181	227	272	279	319	359	399	439	459	464	470	502	565	627	690	697
9"	121	153	204	255	279	314	359	404	449	459	465	494	529	565	635	642	706	770
10"	121	170	227	269	299	349	399	449	459	465	470	549	588	627	642	713	784	855
11"	121	187	249	274	329	384	439	459	465	474	517	604	647	690	706	784	862	941
12"	121	204	272	299	359	419	459	465	470	517	565	659	679	699	770	855	941	1,026
14"	159	238	279	349	419	459	464	494	549	604	659	699	748	798	898	998	1,098	1,198
15"	170	255	299	374	439	464	470	529	588	647	679	748	802	855	962	1,069	1,176	1,283
16"	181	272	319	399	459	469	502	565	627	690	699	798	855	912	1,026	1,140	1,255	1,369
18"	204	289	359	415	465	494	565	635	642	706	770	898	962	1,026	1,155	1,283	1,411	1,540

For larger plaques please email for quote.

## 1/4" STAINLESS STEEL or ALUMINUM

SIZE	2"	3"	4"	5"	6"	7"	8"	9"	10"	11"	12"	14"	15"	16"	18"	20"	22"	24"
2"	\$127	\$127	\$127	\$127	\$127	\$127	\$127	\$127	\$127	\$127	\$127	\$172	\$184	\$197	\$221	\$246	\$271	\$295
3"	127	127	127	127	127	127	127	166	184	203	221	258	277	295	295	328	361	393
4"	127	127	127	127	127	172	197	221	246	271	295	306	328	350	393	437	481	525
5"	127	127	127	154	184	215	246	277	295	301	328	383	410	437	470	480	484	527
6"	127	127	127	184	221	258	295	295	328	361	393	459	492	500	505	527	580	633
7"	127	127	172	215	258	301	306	344	383	421	459	490	495	505	554	615	677	738
8"	127	127	197	246	295	306	350	393	437	475	495	505	527	563	633	703	774	776
9"	127	166	221	277	295	344	393	443	455	480	495	554	593	633	712	727	800	872
10"	127	184	246	295	328	383	437	455	465	484	527	615	659	703	727	808	889	969
11"	127	203	271	301	361	421	475	480	484	532	580	677	725	774	800	889	977	1,066
12"	127	221	295	328	393	459	495	495	527	580	633	738	745	776	872	969	1,066	1,163
14"	172	258	306	383	459	490	505	554	615	677	738	792	848	905	1,018	1,131	1,244	1,357
15"	184	277	328	410	492	495	527	593	659	725	745	848	909	969	1,091	1,212	1,333	1,454
16"	197	295	350	437	500	505	563	633	703	774	776	905	969	1,034	1,163	1,293	1,422	1,551
18"	221	295	393	470	505	554	633	712	727	800	872	1,018	1,091	1,163	1,309	1,454	1,600	1,745

For larger plaques please email for quote.

### PRICING NOTES:

- **Halftone Photographs & Complex Line Art** – For halftone photograph up to 24" x 24" or complex line art add a minimum of \$179; please email for a quote. Not available in aluminum
- **Artwork** – Art charges will be billed for any cleanup required to produce a satisfactory etched product.
- **Custom Color Match** – Add \$200 for each custom color swatch match. We require at least a 3" x 3" sample of the color.
- **Multi-color Paint Fill** – Add \$92 per color (up to 2 colors) additional colors email for quote.
- **Polished Finish** – Available only on recessed copy plaques; add 60%. Not all plaques may be polished. Size limitations may apply. Please email for a quote.
- **Random Orbital** – Add 30%. (recessed copy plaques only)
- **Oversize shipping** – will apply to plaques with a single dimension 36" and larger.



## Etched Bronze and Brass

The tables on these pages show base pricing for our etched plaques.

Pricing includes a brushed finish and single-color fill. For questions, larger

sizes or custom finishes, please email [Plaques@GeminiMade.com](mailto:Plaques@GeminiMade.com)

### 1/16" BRONZE or BRASS

SIZE	2"	3"	4"	5"	6"	7"	8"	9"	10"	11"	12"	14"	15"	16"	18"	20"	22"	24"
2"	\$144	\$144	\$144	\$144	\$144	\$144	\$144	\$144	\$144	\$144	\$144	\$172	\$184	\$196	\$221	\$245	\$270	\$294
3"	144	144	144	144	144	144	144	166	184	202	221	257	276	294	294	319	351	383
4"	144	144	144	144	144	172	196	221	245	270	294	298	319	340	383	425	468	475
5"	144	144	144	153	184	215	245	276	280	292	319	372	399	425	435	435	478	522
6"	144	144	144	184	221	257	287	287	319	351	383	446	478	487	490	522	574	626
7"	144	144	172	215	257	295	298	335	372	409	446	446	478	487	548	609	670	
8"	144	144	196	245	287	298	340	383	425	468	510	515	522	557	626			
9"	144	166	221	276	287	335	383	431	478	485	510	548	587	626				
10"	144	184	245	280	319	372	425	478	480	485	522	609	652					
11"	144	202	270	292	351	409	468	485	485	526	574	670						
12"	144	221	294	319	383	446	510	510	522	574	626							
14"	172	257	298	372	446	446	515	548	609	670								
15"	184	276	319	399	478	478	522	587	652									
16"	196	294	340	425	487	487	557	626										
18"	221	294	383	435	490	548	626											

Recommend 1/8" or 1/4" thick material

For larger plaques please email for quote.

### 1/8" BRONZE or BRASS

SIZE	2"	3"	4"	5"	6"	7"	8"	9"	10"	11"	12"	14"	15"	16"	18"	20"	22"	24"
2"	\$153	\$153	\$153	\$153	\$153	\$153	\$153	\$153	\$153	\$153	\$153	\$185	\$199	\$212	\$238	\$265	\$291	\$300
3"	153	153	153	153	153	153	153	179	199	218	238	278	298	318	325	341	375	409
4"	153	153	153	153	153	185	212	238	265	291	318	318	341	364	409	455	500	510
5"	153	153	153	166	199	232	265	298	307	313	341	398	426	455	480	495	505	551
6"	153	153	153	199	238	278	318	318	341	375	409	477	511	520	525	551	606	661
7"	153	153	185	232	278	315	318	358	398	438	477	520	525	525	578	643	707	771
8"	153	153	212	265	318	318	364	409	455	500	510	525	551	588	661	734	808	813
9"	153	179	238	298	318	358	409	460	511	515	525	578	620	661	744	762	838	914
10"	153	199	265	307	341	398	455	511	515	525	551	643	689	734	762	847	931	1,016
11"	153	218	291	313	375	438	500	515	525	555	606	707	757	808	838	931	1,024	1,118
12"	153	238	318	341	409	477	510	525	551	606	661	771	785	813	914	1,016	1,118	1,219
14"	185	278	318	398	477	520	525	578	643	707	771	830	889	948	1,067	1,185	1,304	1,422
15"	199	298	341	426	511	525	551	620	689	757	785	889	953	1,016	1,143	1,270	1,397	1,524
16"	212	318	364	455	520	525	588	661	734	808	813	948	1,016	1,084	1,219	1,355	1,490	1,626
18"	238	325	409	480	525	578	661	744	762	838	914	1,067	1,143	1,219	1,372	1,524	1,676	1,829

For larger plaques please email for quote.

## 3/16" BRONZE or BRASS

SIZE	2"	3"	4"	5"	6"	7"	8"	9"	10"	11"	12"	14"	15"	16"	18"	20"	22"	24"
2"	\$160	\$160	\$160	\$160	\$160	\$160	\$160	\$160	\$160	\$160	\$160	\$196	\$210	\$224	\$252	\$280	\$308	\$336
3"	160	160	160	160	160	160	160	189	210	231	252	294	315	336	352	391	431	470
4"	160	160	160	160	160	196	224	252	280	308	336	365	391	417	470	522	574	605
5"	160	160	160	175	210	245	280	315	326	359	391	457	489	522	566	574	605	609
6"	160	160	160	210	252	294	336	352	391	431	470	548	557	565	587	609	670	731
7"	160	160	196	245	294	343	365	411	457	502	548	550	560	568	639	710	781	852
8"	160	160	224	280	336	365	417	470	522	574	626	633	645	649	731	812	867	881
9"	160	189	252	315	352	411	470	528	587	590	630	639	685	731	822	826	909	992
10"	160	210	280	326	391	457	522	587	590	595	635	710	761	812	826	918	1,010	1,102
11"	160	231	308	359	431	502	574	590	595	614	670	781	837	877	909	1,010	1,111	1,212
12"	160	252	336	391	470	548	626	630	635	670	731	852	875	881	992	1,102	1,212	1,322
14"	196	294	365	457	548	550	633	639	710	781	852	900	964	1,028	1,157	1,285	1,414	1,542
15"	210	315	391	489	557	560	645	685	761	837	875	964	1,033	1,102	1,239	1,377	1,515	1,653
16"	224	336	417	522	565	568	649	731	812	877	881	1,028	1,102	1,175	1,322	1,469	1,616	1,763
18"	252	352	470	566	587	639	731	822	826	909	992	1,157	1,239	1,322	1,487	1,653	1,818	1,983

For larger plaques please email for quote.

## 1/4" BRONZE or BRASS

SIZE	2"	3"	4"	5"	6"	7"	8"	9"	10"	11"	12"	14"	15"	16"	18"	20"	22"	24"
2"	\$163	\$163	\$163	\$163	\$163	\$163	\$163	\$163	\$163	\$163	\$163	\$206	\$221	\$235	\$265	\$294	\$324	\$353
3"	163	163	163	163	163	163	163	199	221	243	265	309	331	353	360	391	431	470
4"	163	163	163	163	163	206	235	265	294	324	353	365	391	417	470	522	574	626
5"	163	163	163	184	221	257	294	331	352	359	391	457	489	522	587	605	615	638
6"	163	163	163	221	265	309	353	365	391	431	470	548	587	590	600	638	702	765
7"	163	163	206	257	309	360	365	411	457	502	548	585	590	595	670	744	819	893
8"	163	163	235	294	353	365	417	470	522	574	585	590	638	680	765	850	935	974
9"	163	199	265	331	365	411	470	528	587	605	625	670	718	765	861	913	1,005	1,096
10"	163	221	294	352	391	457	522	587	605	615	638	744	797	850	913	1,015	1,116	1,218
11"	163	243	324	359	431	502	574	605	615	643	702	819	877	935	1,005	1,116	1,228	1,339
12"	163	265	353	391	470	548	585	625	638	702	765	893	913	974	1,096	1,218	1,339	1,461
14"	206	309	365	457	548	585	590	670	744	819	893	994	1,065	1,137	1,279	1,421	1,563	1,705
15"	221	331	391	489	587	590	638	718	797	877	913	1,065	1,142	1,218	1,370	1,522	1,674	1,827
16"	235	353	417	522	590	595	680	765	850	935	974	1,137	1,218	1,299	1,461	1,624	1,786	1,948
18"	265	360	470	587	600	670	765	861	913	1,005	1,096	1,279	1,370	1,461	1,644	1,827	2,009	2,192

For larger plaques please email for quote.

### PRICING NOTES:

- **Halftone Photographs & Complex Line Art** – For halftone photograph up to 24" x 24" or complex line art add a minimum of \$179; please email for a quote. Not available in aluminum
- **Artwork** – Art charges will be billed for any cleanup required to produce a satisfactory etched product.
- **Custom Color Match** – Add \$200 for each custom color swatch match. We require at least a 3" x 3" sample of the color.
- **Multi-color Paint Fill** – Add \$92 per color (up to 2 colors) additional colors email for quote.
- **Polished Finish** – Available only on recessed copy plaques; add 60%. Not all plaques may be polished. Size limitations may apply. Please email for a quote.
- **Random Orbital** – Add 30%. (recessed copy plaques only)
- **Oversize shipping** – will apply to plaques with a single dimension 36" and larger.



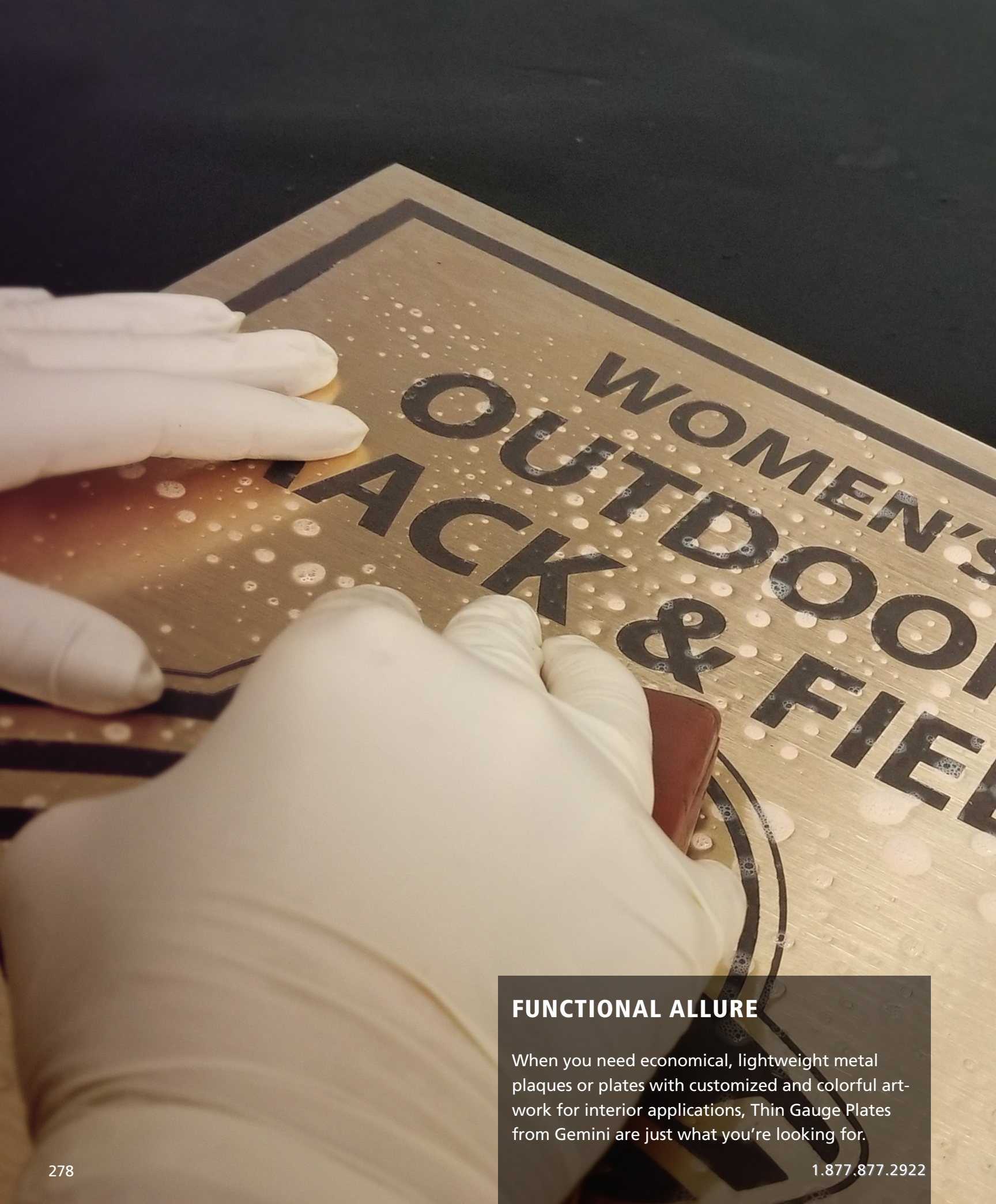

## FUNCTIONAL ALLURE

When you need economical, lightweight metal plaques or plates with customized and colorful artwork for interior applications, Thin Gauge Plates from Gemini are just what you're looking for.





# THIN GAUGE PLAQUES

Stainless steel, brass  
or aluminum

Etched, printed or  
sublimated

Multiple thicknesses  
to choose from

Sizes up to 23" x 36"

Industry leading  
production

## AFFORDABLE STYLE FOR INTERIOR APPLICATIONS

Thin Gauge Plaques from Gemini are the ideal solution for custom etched interior signage, wayfinding, name tags, product plates and sequential identifiers such as room or locker numbers. This solution affordably accommodates large volume applications in ways that bring uniformity and style to any interior environment. Like many of Gemini's other plaque products, Thin Gauge Plaques let you choose from a variety of rich alloys and finishes, but with the added versatility of multi-color paint fills, printing, and sublimation to support a wide variety of applications.

### WHEN ORDERING

PLEASE SPECIFY:

- Artwork & Critical Dimensions
- Material & Thickness
- Paint Fill Color
- Finish Selection
- Thru Hole or Tape Mount



## AFFORDABILITY IS BEAUTIFUL

### Beauty that doesn't break the bank.

Are you looking for an affordable option that still has a high-quality feel? Thin gauge plaques offer an economical solution for interiors. Like our other plaque options, they offer classic, durable elements in a variety of finishes and mounting options. Thin gauge plaques do not have finished returns and are not available with stud mounts. They are available with the options for holes or adhesive backs for mounting.

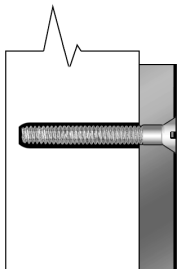

**Thru-hole**

Two or four thru-holes in 1/16, 1/8 or 3/16" diameters (Hardware not included)

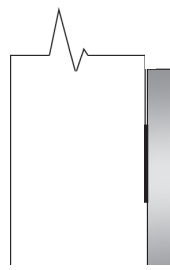

**Double Face Tape**

2mil thick tape included in cost (interior use only)

**Minimum and Maximum Height:** 1" – 36"

**Max Size (if applicable):** 5.75 sq ft / 828 sq in (eg 23" x 36")

**Depth(s):** .020", .025", .029", .040" & .050"

**Indoor Only:** Brass, Printed Aluminum & DynaSub

**Indoor or Indoor/Outdoor:** Stainless steel, anodized aluminum & DuraLuxe

**Material(s):** Stainless steel, brass copper, nickel silver, or aluminum

**Common applications:**

- Interior and (some) exterior wayfinding
- Sequential identifications
- Name tags
- Large volume needs

Most thin gauge plaques should be used indoors. For outdoor applications, consider the Duraluxe, stainless steel and anodized aluminum.

**Alloys:** (Also Nickel Silver)

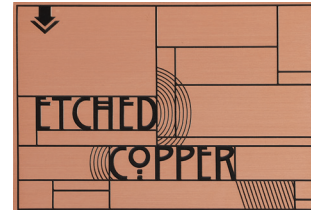
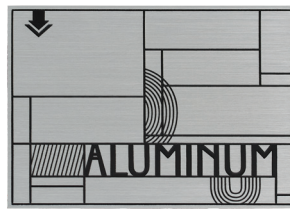
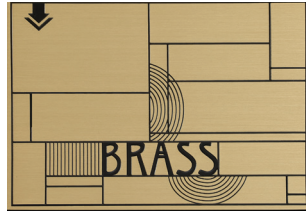

**Finishes:**



Etched & Color-filled



Etched & Frosted



Etched & Antiqued



Sublimated / DuraLux



Printed

**Corner Shapes:**



Square



Rounded

1/8", 3/16" or 1/4" radius



Clipped



Inverted

1/8", 3/16" or 1/4" radius

**Screen Print Colors:**

Standard screen print and etch fill colors are shown below. These are approximate color references. Color may vary depending on substrate color and finish.

No. 10 Red	No. 13 Medium Blue	No. 14 Reflex Blue	No. 15 Dark Blue	No. 18 Black	No. 21 Brown	No. 25 White	No. 28 Yellow	No. 31 Green	No. 35 Burgundy	No. 40 Gold	No. 41 Silver
1805C	3015C	Reflex Blue	294C	Process Black	4625C	White	108C	348C	202C	871C	877C

*Approximate PMS Colors*



## ETCHED 304 STAINLESS STEEL

The tables on these pages show base pricing for our thin gauge - quantity etched plates. Pricing includes your choice of a one color fill or a frosted finish, up to four holes, and choice of square, round, inverted, or clipped corners. Restrictions may apply for color fill backgrounds that bleed off the edge of the plate. All returns are unpainted.

### Etched & Color Filled Stainless Steel - Price Per Piece

TOTAL AREA PER PIECE	THICKNESS	1-9 PIECES	10-24 PIECES	25-49 PIECES	50-99 PIECES	100-249 PIECES	250-499 PIECES	500-749 PIECES	750-999 PIECES	1000+ PIECES
up to 3 sq in	.029"	\$56.59	\$41.55	\$33.34	\$17.07	\$8.82	\$4.91	\$3.91	\$3.81	\$3.43
	.050"	65.52	48.12	38.60	19.79	10.21	5.68	4.53	4.42	3.96
4 to 6 sq in	.029"	63.06	45.66	35.39	18.26	9.94	7.00	6.00	5.68	3.83
	.050"	73.02	52.87	40.96	21.14	11.52	8.10	6.93	6.58	4.46
7 to 9 sq in	.029"	70.49	52.98	36.51	20.28	12.38	9.30	8.49	8.21	7.66
	.050"	81.62	61.34	42.27	23.47	14.34	10.78	9.83	9.52	8.89
10 to 12 sq in	.029"	76.85	65.10	37.63	22.98	14.91	12.38	10.60	10.32	9.72
	.050"	88.97	75.38	43.57	26.61	17.26	14.34	12.27	11.96	11.26
13 to 24 sq in	.029"	84.92	73.92	52.08	35.81	29.82	24.75	22.81	22.46	21.42
	.050"	98.30	85.60	60.29	41.46	34.51	28.66	26.42	26.02	24.81
25 to 36 sq in	.029"	119.32	103.71	60.02	52.44	42.98	37.52	35.19	34.91	33.43
	.050"	138.17	120.09	69.50	60.71	49.77	43.44	40.74	40.41	38.71
37 to 50 sq in	.029"	124.47	112.64	69.33	65.54	53.29	47.29	44.74	43.43	42.74
	.050"	144.13	130.43	80.28	75.37	61.28	54.39	51.46	49.73	49.16
51 to 65 sq in	.029"	145.14	116.59	81.14	69.11	57.54	51.44	48.65	47.51	46.61
	.050"	168.06	134.98	93.96	80.02	66.62	59.56	56.33	54.64	53.97
66 to 80 sq in	.029"	173.98	144.13	114.61	93.70	81.89	75.27	71.88	71.55	68.80
	.050"	201.45	166.90	132.70	108.50	94.82	87.16	83.23	82.85	79.67
Over 80 sq in		EMAIL FOR QUOTE								

#### PRICING NOTES:

- Additional setup fees are required for personalization, sequential printing or multiple colors. Contact Plaques@GeminiMade.com
- .022" 304 Stainless Steel - Add 5% to .029" price above
- .062" 304 Stainless Steel - Add 35% to .029" price above
- .018" 430 Stainless Steel - Deduct 10% from .029" price above
- .029" 430 Stainless Steel - Deduct 5% from .029" price above
- .050" 430 Stainless Steel - Add 5% to .029" price above
- .022" 316 Stainless Steel - Add 10% to .029" price above
- .029" 316 Stainless Steel - Add 15% to .029" price above
- .050" 316 Stainless Steel - Add 30% to .029" price above



Exterior Signage



Door Numbers



Metal Decals

**ETCHED SATIN BRASS**

The tables on these pages show base pricing for our thin gauge - quantity etched plates. Pricing includes your choice of a one color fill, a frosted or antiqued finish, up to four holes, and choice of square, round, inverted, or clipped corners. Restrictions may apply for color fill backgrounds that bleed off the edge of the plate. All returns are unpainted.

**Etched & Color Filled Brass - Price Per Piece**

TOTAL AREA PER PIECE	THICKNESS	1-9 PIECES	10-24 PIECES	25-49 PIECES	50-99 PIECES	100-249 PIECES	250-499 PIECES	500-749 PIECES	750-999 PIECES	1000+ PIECES
up to 3 sq in	.020"	\$54.14	\$39.76	\$31.89	\$16.35	\$8.44	\$4.70	\$3.73	\$3.65	\$3.28
	.040"	73.09	53.68	43.06	22.07	11.40	6.33	5.05	4.93	4.43
4 to 6 sq in	.020"	60.33	43.69	33.86	17.49	9.52	6.70	5.73	5.45	3.67
	.040"	81.46	59.00	45.71	23.60	12.85	9.05	7.75	7.35	4.97
7 to 9 sq in	.020"	67.44	50.69	34.94	19.40	11.85	8.90	8.12	7.85	7.33
	.040"	91.05	68.45	47.16	26.19	16.00	12.02	10.97	10.60	9.92
10 to 12 sq in	.020"	73.53	62.30	36.01	21.99	14.27	11.85	10.14	9.89	9.30
	.040"	99.28	84.10	48.61	29.69	19.25	16.00	13.69	13.34	12.55
13 to 24 sq in	.020"	81.25	70.73	49.83	34.26	28.52	23.69	21.84	21.50	20.50
	.040"	109.69	95.49	67.26	46.26	38.51	31.99	29.47	29.02	27.67
25 to 36 sq in	.020"	114.18	99.24	57.43	50.18	41.14	35.91	33.67	33.41	31.99
	.040"	154.14	133.98	77.53	67.75	55.53	48.48	45.46	45.09	43.19
37 to 50 sq in	.020"	119.11	107.79	66.35	56.74	46.14	40.94	38.74	37.92	37.01
	.040"	160.80	145.51	89.57	76.61	62.29	55.27	52.30	51.20	49.96
51 to 65 sq in	.020"	138.89	111.56	77.65	66.13	55.06	49.21	46.56	45.09	44.59
	.040"	187.51	150.60	104.84	89.28	74.33	66.45	62.85	60.87	60.21
66 to 80 sq in	.020"	166.49	137.93	109.67	89.67	78.37	72.03	68.80	68.46	65.85
	.040"	224.76	186.20	148.06	121.06	105.79	97.25	92.87	92.42	88.88
Over 80 sq in		EMAIL FOR QUOTE								

**PRICING NOTES:**

- Additional setup fees are required for personalization, sequential printing or multiple colors. Contact Plaques@GeminiMade.com
- .062" Leaded Brass - Add 50% to .020" price above
- .125" Leaded Brass - Add 150% to .020" price above
- .020" Satin Copper - Add 5% to .020" price above
- .018" Nickel Silver - Add 35% to .020" price above
- .040" Nickel Silver - Add 50% to .020" price above



Memorial



Locker Plate (Antiqued)



Door Plates

# ETCHED SATIN ANODIZED ALUMINUM

The tables on these pages show base pricing for our thin gauge - quantity etched plates. Pricing includes your choice of a one color fill, up to four holes, and choice of square, round, inverted, or clipped corners. Restrictions may apply for color fill backgrounds that bleed off the edge of the plate. All returns are unpainted.

## Etched & Color Filled Anodized Aluminum - Price Per Piece

TOTAL AREA PER PIECE	THICKNESS	1-9 PIECES	10-24 PIECES	25-49 PIECES	50-99 PIECES	100-249 PIECES	250-499 PIECES	500-749 PIECES	750-999 PIECES	1000+ PIECES
up to 3 sq in	.025"	\$48.73	\$35.79	\$28.71	\$14.70	\$7.60	\$4.22	\$3.37	\$3.28	\$2.95
	.050"	51.44	37.77	30.31	15.52	8.02	4.47	3.55	3.47	3.12
4 to 6 sq in	.025"	54.30	39.32	30.47	15.74	8.57	6.03	5.17	4.90	3.30
	.050"	57.32	41.51	32.17	16.60	9.04	6.37	5.45	5.17	3.48
7 to 9 sq in	.025"	60.70	45.63	31.44	17.45	10.67	8.02	7.32	7.07	6.60
	.050"	64.08	48.16	33.19	18.44	11.25	8.45	7.72	7.47	6.97
10 to 12 sq in	.025"	66.18	56.06	32.41	19.79	12.84	10.67	9.12	8.89	8.37
	.050"	69.86	59.18	34.21	20.89	13.55	11.25	9.64	9.39	8.84
13 to 24 sq in	.025"	73.13	63.66	44.84	30.84	25.67	21.32	19.65	19.35	18.45
	.050"	77.19	67.20	47.34	32.56	27.11	22.50	20.74	20.42	19.47
25 to 36 sq in	.025"	102.76	89.32	51.69	45.16	37.02	32.32	30.31	30.06	28.79
	.050"	108.47	94.29	54.56	47.68	39.07	34.11	31.99	31.74	30.39
37 to 50 sq in	.025"	107.21	97.02	59.71	51.07	41.53	36.85	34.87	34.13	33.31
	.050"	113.16	102.40	63.03	53.62	43.60	38.69	36.61	35.87	34.97
51 to 65 sq in	.025"	125.01	100.40	69.88	59.53	49.54	44.29	41.91	40.95	40.14
	.050"	131.94	105.99	73.76	62.83	52.31	46.76	44.23	43.50	42.38
66 to 80 sq in	.025"	149.83	124.14	98.70	80.70	70.53	64.83	61.91	61.61	59.26
	.050"	158.16	131.03	104.19	85.18	74.45	68.43	65.35	65.05	62.55
Over 80 sq in		EMAIL FOR QUOTE								

### PRICING NOTES:

- Price includes satin silver or satin black finish
- Additional setup fees are required for personalization, sequential printing or multiple colors. Contact Plaques@GeminiMade.com

### .125" ANODIZED ALUMINUM:

- Add 50% to .025" pricing above.



Metal Decals



Door Numbers



Interior Signage



**INTERIOR PRINTED ALUMINUM**

The tables on these pages show base pricing for our thin gauge - quantity printed plates. Pricing includes your choice of a one printed color, up to four holes, and choice of square, round, inverted, or clipped corners. Restrictions may apply for printed backgrounds that bleed off the edge of the plate. All returns are unpainted.

**Screen Printed Aluminum - Price Per Piece**

TOTAL AREA PER PIECE	THICKNESS	1-9 PIECES	10-24 PIECES	25-49 PIECES	50-99 PIECES	100-249 PIECES	250-499 PIECES	500-749 PIECES	750-999 PIECES	1000+ PIECES
up to 3 sq in	.025"	\$34.97	\$27.07	\$19.99	\$10.75	\$5.83	\$3.13	\$2.17	\$2.07	\$1.82
	.040"	43.71	33.84	24.99	13.44	7.28	3.92	2.70	2.60	2.27
4 to 6 sq in	.025"	36.67	28.66	21.95	12.12	6.52	3.52	2.77	2.42	2.15
	.040"	45.82	35.81	27.46	15.15	8.15	4.38	3.47	3.02	2.68
7 to 9 sq in	.025"	42.46	33.39	22.95	13.29	7.38	4.75	3.42	3.02	2.72
	.040"	53.09	41.74	28.69	16.60	9.24	5.93	4.27	3.77	3.40
10 to 12 sq in	.025"	46.73	38.61	24.10	14.64	9.32	5.12	3.67	3.30	3.00
	.040"	58.43	48.26	30.14	18.29	11.65	6.40	4.60	4.13	3.75
13 to 24 sq in	.025"	53.23	47.84	29.94	16.37	11.39	7.10	5.65	5.27	4.90
	.040"	66.53	59.80	37.42	20.47	14.22	8.87	7.07	6.58	6.13
25 to 36 sq in	.025"	74.67	57.04	31.57	22.05	13.79	9.55	8.00	7.68	7.20
	.040"	93.35	71.31	39.47	27.56	17.22	11.95	10.00	9.60	9.00
37 to 50 sq in	.025"	78.17	59.63	45.34	34.04	21.87	14.79	12.09	11.65	10.52
	.040"	97.72	74.53	56.68	42.56	27.36	18.49	15.12	14.57	13.15
51 to 65 sq in	.025"	84.00	73.60	51.38	42.01	26.34	18.90	15.95	15.55	14.17
	.040"	105.00	92.00	64.21	52.51	32.92	23.62	19.95	19.44	17.70
66 to 80 sq in	.025"	103.29	80.57	72.38	49.74	33.14	25.46	22.32	21.79	19.89
	.040"	129.12	100.72	90.47	62.18	41.42	31.81	27.89	27.22	24.85
Over 80 sq in		<b>EMAIL FOR QUOTE</b>								

**PRICING NOTES:**

- Pricing includes satin gold, silver, and black; gloss black or white
- Additional setup fees are required for personalization, sequential printing or multiple colors. Contact Plaques@GeminiMade.com
- .020" Brass - Add 20% to .025 price above
- .040" Brass - Add 55% to .025 price above
- .020" Copper - Add 25% to .025 price above
- .025" Anodized Aluminum - Add 10% to .025 price above
- .050" Anodized Aluminum - Add 30% to .025 price above
- .022" 304 Stainless Steel - Add 5% to .025 price above
- .029" 304 Stainless Steel - Add 10% to .025 price above
- .050" 304 Stainless Steel - Add 20% to .025 price above
- .015" 430 Stainless Steel - Same as .025 price above
- .029" 430 Stainless Steel - Add 5% to .025 price above
- .050" 430 Stainless Steel - Add 15% to .025 price above
- .022" 316 Stainless Steel - Add 20% to .025 price above
- .029" 316 Stainless Steel - Add 30% to .025 price above
- .050" 316 Stainless Steel - Add 50% to .025 price above
- .018" Nickel Silver - Add 55% to .025 price above
- .062" 304 Stainless Steel - Add 30% to .025 price above
- .050" Nickel Silver - Add 80% to .025 price above



Interior Signage

This property is professionally managed by:

**M R G**

MERIDIAN REALTY GROUP LLC

Boston, MA  
617-517-0854  
www.mrgproperty.com

Interior Signage

# SUBLIMATED INTERIOR ALUMINUM

The table on this page shows base pricing for our sublimated interior aluminum plates. Pricing includes unlimited spot colors or four-color process printing, up to four holes, and choice of square, round, inverted or clipped corners. All returns are unpainted.

## Sublimated Interior Aluminum - Price Per Piece

TOTAL AREA PER PIECE	THICKNESS	1-9 PIECES	10-24 PIECES	25-49 PIECES	50-99 PIECES	100-249 PIECES	250-499 PIECES	500-749 PIECES	750-999 PIECES	1000+ PIECES
up to 3 sq in	.020"	\$26.28	\$22.39	\$16.57	\$16.57	\$3.67	\$1.99	\$1.44	\$1.39	\$1.06
	.040"	32.85	27.98	20.71	20.71	4.59	2.49	1.80	1.74	1.32
4 to 6 sq in	.020"	27.03	21.76	18.20	18.20	4.03	2.59	1.89	1.60	1.39
	.040"	33.78	27.20	22.75	22.75	5.03	3.24	2.36	2.00	1.74
7 to 9 sq in	.020"	31.21	25.85	18.71	18.71	4.75	3.36	2.40	2.08	1.85
	.040"	39.02	32.31	23.39	23.39	5.94	4.21	3.00	2.60	2.31
10 to 12 sq in	.020"	36.16	29.94	19.57	19.57	5.39	3.96	2.70	2.39	2.14
	.040"	45.20	37.43	24.47	24.47	6.73	4.95	3.38	2.99	2.67
13 to 24 sq in	.020"	45.68	37.83	23.60	23.60	9.38	5.64	4.42	4.10	3.79
	.040"	57.10	47.28	29.50	29.50	11.73	7.05	5.52	5.12	4.74
25 to 36 sq in	.020"	54.56	45.18	26.86	26.86	11.29	7.72	6.41	6.14	5.73
	.040"	68.19	56.48	33.58	33.58	14.11	9.65	8.01	7.67	7.16
37 to 50 sq in	.020"	57.54	47.65	28.70	28.70	14.50	12.15	11.00	9.57	8.60
	.040"	71.92	59.57	35.87	35.87	18.13	15.19	13.75	11.96	10.76
51 to 65 sq in	.020"	71.12	58.90	33.23	33.23	18.14	15.56	14.21	13.25	11.71
	.040"	88.91	73.63	41.53	41.53	22.68	19.45	17.76	16.57	14.64
66 to 80 sq in	.020"	77.90	64.51	42.07	42.07	25.17	22.28	20.68	18.20	16.59
	.040"	97.37	80.64	52.59	52.59	31.46	27.85	25.85	22.75	20.74
Over 80 sq in		EMAIL FOR QUOTE								

### PRICING NOTES:

- Pricing includes satin silver or gloss white finish.
- Additional setup fees are required for personalization, sequential printing or multiple colors. Contact [Plaques@GeminiMade.com](mailto:Plaques@GeminiMade.com)
- .020" Brass - Add 25% to .020 price above
- .020" Satin Copper - Add 30% to .020 price above
- .015" Laquered Steel - Add 15% to .020 price above
- .022" Erasable Steel - Add 10% to .020 price above
- .020" LaserSub Aluminum - Add 5% to .020 price above
- .015" Brass Plated Steel - Add 20% to .020 price above
- .015" LaserSub Steel - Add 35% to .020 price above



Door Plate

## DURALUXE™ – SUBLIMATED EXTERIOR ALUMINUM

The table on this page shows base pricing for our sublimated exterior aluminum plates. Pricing includes unlimited spot colors or four-color process printing, up to four holes, and choice of square, round, inverted or clipped corners. All returns are unpainted. Our exterior sublimated plates are UV resistant, scratch and graffiti proof.

### Sublimated Exterior Aluminum - Price Per Piece

TOTAL AREA PER PIECE	THICKNESS	1-9 PIECES	10-24 PIECES	25-49 PIECES	50-99 PIECES	100-249 PIECES	250-499 PIECES	500-749 PIECES	750-999 PIECES	1000+ PIECES
up to 3 sq in	.050"	\$44.13	\$37.66	\$28.04	\$13.19	\$6.23	\$3.37	\$2.43	\$2.35	\$1.78
4 to 6 sq in	.050"	45.37	36.62	30.74	14.39	6.85	4.42	3.20	2.72	2.35
7 to 9 sq in	.050"	51.43	42.66	31.06	15.34	8.08	5.72	4.08	3.55	3.15
10 to 12 sq in	.050"	59.46	49.33	32.46	16.52	9.15	6.75	4.58	4.08	3.63
13 to 24 sq in	.050"	73.65	61.08	38.36	22.02	15.62	9.64	7.70	7.17	6.68
25 to 36 sq in	.050"	87.85	72.83	43.56	29.69	18.67	12.97	10.87	10.09	9.79
37 to 50 sq in	.050"	91.81	76.12	46.09	31.61	23.60	19.87	18.05	15.35	14.25
51 to 65 sq in	.050"	113.34	93.94	53.26	38.16	29.37	25.29	23.14	20.84	19.19
66 to 80 sq in	.050"	124.06	102.82	67.28	50.76	40.49	35.92	33.39	28.38	26.92
Over 80 sq in		EMAIL FOR QUOTE								

**PRICING NOTES:**

- Additional setup fees are required for personalization, sequential printing or multiple colors. Contact [Plaques@GeminiMade.com](mailto:Plaques@GeminiMade.com)
- Material is gloss white aluminum



Exterior Signage

**mateco** TRUCK EQUIPMENT  
 6434 Stuebner Airline  
 HOUSTON, TX 77091  
[www.matecotruck.com](http://www.matecotruck.com)  
**800-982-3206**

Exterior Signage



## What do you mean by lifetime guarantee?

Gemini guarantees all of its exterior products for life. This means that should any Gemini produced product fade, break or contain any defect, we will refinish or replace the defective materials at no cost to you, as long as they are installed on their original location.

Neither seller nor manufacturer shall be liable for any injury, loss or damage, direct or consequential, arising out of the use of or the inability to use the product.

Keep in mind that all exterior letters will require some maintenance to retain their original luster. All plastic and metal letters should be periodically cleaned with a good dish soap and water to remove any dirt or pollutants gathered from the environment. Should the face of a metal letter get scratched, the polyurethane coating can be revitalized using a good car wax.

## What is your return policy?

Most Gemini products are custom made to order for specific customers. But as a service to you, we may offer a credit up to 50% of the original net price, up to \$500. Should you need to return any goods that were ordered in error, canceled by the end user, or not needed. All you do is call for an RMA (Return Material Authorization) number, and return at least one half of the product, to the appropriate plant, as given to you when you call. You do pay the freight for the return.

## Does Gemini's Guarantee cover letters installed in harsh environments?

Yes. As stated in Gemini's warranty statement—Gemini will replace or rework all Gemini exterior rated products that fail in the field, but not cover your costs of removal, reinstallation, or any subsequent work done on the sign mounting surface. Therefore, it is important to keep the sign's environment in mind when selecting the material and finish of letters that will be placed there.

Gemini has a wide range of products that stretch from the most stable in UV and chemical resistance (Formed Letters, Anodized Aluminum, and Painted products) to the most susceptible to failure when placed in harsh environments (Polished Brass, Brushed Aluminum, and Laminated Letters).

Impact resistance is also an issue when examining the regular wear and tear that may be present on a sign. Letters made from acrylic are always more prone to breakage than those made from CAB (Formed Plastic, Minnesota Letters) or metal.

Despite our best aluminum alloys, powder coats, and finishing techniques—aluminum remains extremely reactive and will degrade when placed in an area with moderate UV exposure and harsh chemical or excessive moisture contact. The only way to ensure that aluminum letters do not corrode is to anodize the surface of the letter.

## What art files can I send in for quotes or orders?

Gemini's systems are IBM compatible. The best files to send us are Illustrator (.ai, .eps or .pdf), Corel (.cdr), Gerber (.plt), Flexi (.fs), or Signlab (.eps). We can also convert Mac EPS files.

Please be sure to convert to "curves" or "paths" before sending. Be sure to clearly identify your company name, phone number and reference any quotation number you may have received. Large files (over 10MB) can be uploaded by going to [www.GeminiSignage.com](http://www.GeminiSignage.com) and login to the Partner Portal.

## How will my order be delivered?

Most orders will ship via UPS ground, at our Guaranteed Ground freight rate (see pg. 270), unless otherwise requested by you.

You pay the freight, so it is your option to ship via air freight if you need your order sooner.

Many overnight, 2-day, and 3-days options are available. Larger letters may have to ship via truck freight. These orders may ship freight collect with a carrier of your choice.

## Why does Gemini send an art approval drawing?

Standard Font Orders:

- Does not fit line length given
- Does not match art provided (Ex. Looks like Helvetica but Helvetica Bold was given)

Custom Cut Acrylic, Formed & Laminate Orders:

- Orders over \$1,500
- Orders with art modification to meet production restrictions
- Orders with unclear details

Custom Cut Metal & Cast Metal Orders:

- Orders over \$1,500
- Orders with art modification to meet production restrictions
- Orders with unclear details
- Labor intense polished, anodized or premium

Others:

- Complicated painted jobs
- 3D proofs (sculpted)
- Orders with any art modification
- All Fabricated, Plaques & UV Print (Giclee)

## What size letters do I need to order?

Below is a letter visibility chart that has been made for you based upon information provided by Pennsylvania Transportation Institute, Penn State University and the United States Sign Council. Please refer to the complete study for additional information. For further details contact the USSC at 1-215-785-1922.

### Letter Visibility Chart

Viewing Distance	Minimum Letter Height
100 ft.	4"
250 ft.	10"
360 ft. (city block)	16"
500 ft.	22"
750 ft.	33"
1000 ft.	43"
1320 ft. (1/4 mile)	57"

## When does Gemini require a deposit on large orders?

A deposit may be considered on any order over \$1,500 upon review of order history, payment history and our overall experience together. Should a deposit be needed a representative from Account Services will personally connect with your Account Payable to discuss a payment arrangement. A 50% deposit is typically requested, while extremely large projects or special situations are often deserving of a customized plan to move the project along. As large order history develops and with promising payment history, deposits often become a thing of the past. Please reach out to our Account Services team with specific deposit questions at 877-702-5559 or [Credit@Gemini-Made.com](mailto:Credit@Gemini-Made.com).

## When can I use double face tape and what does Gemini offer with this mounting method?

Gemini provides a 25mil, high quality, VHB or UHB tape on thin plaques, Flat Cut Acrylic, or Display products. We recommend this installation only on flat, smooth, interior walls. Letters are supplied with either partial or full tape coverage – based on the size. Thin plaques are supplied with strips of tape. Full tape coverage can be supplied for letters - upon request - with an additional fee.

We also recommend using a quality adhesive (construction grade or epoxy) to accompany all tape installations. Be sure to follow all required tape installation steps, especially applying ample pressure to properly set tape.

## Is there a specific sales person I should contact regarding my account?

Any of our Gemini Customer Service team members will be able to assist you with your questions and quote/order requests. Depending on the complexity of the request/question or the product type we have a variety of specialized teams available to partner with you to find the best possible solution or answer to your question.

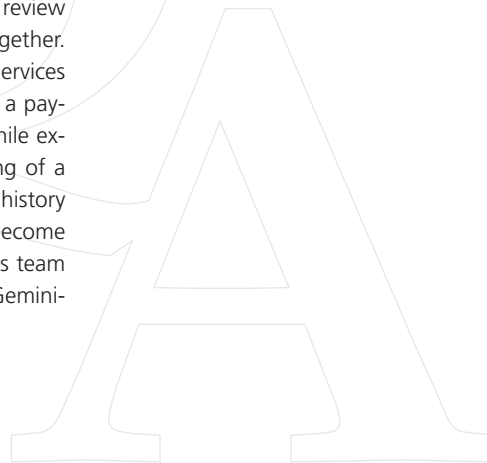

# Guaranteed Ground Freight\*

## How to calculate freight and all additional charges

Gemini's Guaranteed Ground Freight schedule is a one-rate freight charge that includes all freight and handling for a single order. Please ask a customer service representative if you have any questions. Unless you are subject to a local tax or have COD terms, this is the total amount that will be added to your bill to deliver Gemini products to your door. Sales tax may apply when shipping to the following US states: CA, MN, IA, NV, TX, VA & WA and for COD terms, add \$16.50 to the Guaranteed Ground Freight rate based on your order total.

Gemini only has UPS scheduled pick-ups. An \$8.00 per order pick-up charge is assessed for other specified carriers. An additional day will be added to the delivery date when a specified carrier pick-up is requested due to their requiring a one day advance notice prior to shipment.

If you decide not to use Gemini's Guaranteed Ground Freight, Gemini charges an \$8.00 handling fee per order. If you request to use your own UPS account, it will be used for all UPS shipments.

Total Order Value	Updated Guaranteed Ground Freight
Up to \$25	\$10.99
\$25.01 - \$50.00	\$13.99
\$50.01 - \$150.00	\$21.99
\$150.01 - \$300.00	\$32.99
\$300.01 - \$450.00	\$42.99
\$450.01 - \$800.00	\$59.99
\$800.01 - \$1,200.00	\$79.99
\$1,200.01 - \$1,600.00	\$94.99
\$1,600.01 - \$2,000.00	\$114.99
\$2,000.01 - \$3,500.00	\$169.99
\$3,500.01 - \$5,000.00	\$244.99
Over \$5,000	\$299.99

\* Excludes products with any dimension 70" or greater

## Expedited Freight

Expedited freight is also available but is billed at normal published rates from the point of origin of the Gemini manufacturing location to your delivery destination. Freight estimates are available by contacting Gemini's customer service at 1-800-LETTERS (538-8377).

## Oversize Packaging

Several items in the catalog are noted to be oversized. These items may require special packaging or incur oversize surcharges when shipped via UPS or via truck. Special truck freight requirements, such as lift gates, may also incur additional freight surcharges above the guaranteed ground freight rates.

## Simplify Your Payments

Gemini has a long history of working with sign professionals to provide them with high quality products at the lowest prices. This includes offering the most convenient and seamless payment options that best fit their company. These options include:

- Net Terms – Conveniently pay anytime, 24/7 through our online Payment Portal via ACH or credit card with no additional fees. You can view your invoices, balances and select from several auto-payment options. An approved credit application is required, and invoices are due in 30 days.
- Prepay Terms – The full amount of the order is paid before releasing to production. Payment can be made through the Payment Portal via ACH or credit card 24/7.
- Credit Card Terms – Credit card information is required at the time the order is placed and the funds are reserved immediately for the full order amount. Funds are captured the day after shipping.



### Plastic Blocks to receive studs

Threaded plastic blocks (made with CAB plastic) to receive studs. Glue or solvent bond to plastic letters / logos

PART NUMBER	DESCRIPTION	EACH	USE WITH	STUD TYPE	STUD OPTIONS
GI-68	¼" Diam. x ¾" Long	\$0.69	6-32 STUDS	ALUMINUM STAINLESS STEEL	1½", 2" 1", 1½", 2", 3"
GI-35	¾" x ½" x ¾" Long	0.53	10-24 STUDS	ALUMINUM STAINLESS STEEL	1", 1½", 2", 3", 4", 5", 6" 1", 1½", 2", 3", 4", 5", 6"
GI-18	½" Diam. x ¾" Long	0.53	10-24 STUDS	ALUMINUM STAINLESS STEEL	1", 1½", 2", 3", 4", 5", 6" 1", 1½", 2", 3", 4", 5", 6"
GI-14	1" Diam. x 1¾" Long	0.79	10-24 STUDS	ALUMINUM STAINLESS STEEL	1", 1½", 2", 3", 4", 5", 6" 1", 1½", 2", 3", 4", 5", 6"
GI-13	1" Diam. x 5/8" Long	0.79	10-24 STUDS	ALUMINUM STAINLESS STEEL	1", 1½", 2", 3", 4", 5", 6" 1", 1½", 2", 3", 4", 5", 6"



### Plastic Pads with threaded thru hole (screws onto studs)

Plastic pads (made with CAB plastic) with threaded hole for 10-24 studs. Thread pad onto stud to create a stand-off or combination mount. Adhere pad to mounting surface with silicone or construction adhesive.

PART NUMBER	DESCRIPTION	EACH	USED TO INSTALL
GI-005	¾" Diameter	\$0.53	Formed, I.M., Laser Cut or Display Letters
GI-00	1" Diameter	0.53	Formed, I.M., Laser Cut or Display Letters
GI-01	1¾" Diameter	0.63	Formed, I.M., Laser Cut or Display Letters
GI-000	3" Diameter	0.79	Formed, I.M., Laser Cut or Display Letters

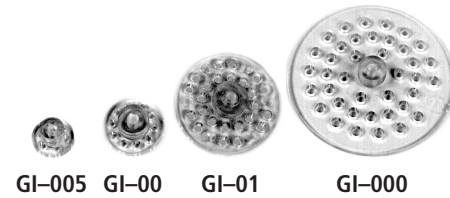

### Plastic Pads with studs (screws into stud blocks)

Threaded plastic pads (made with CAB plastic) with non-removable 10-24 studs. Thread stud into stud block to create a pad mount with a stand-off. Adhere pad to mounting surface with silicone or construction adhesive.

PART NUMBER	DESCRIPTION	EACH	USED TO INSTALL
GI-30	½" Stud Length	\$0.79	Formed, I.M., Laser Cut or Display Letters
GI-31	¾" Stud Length	0.79	Formed, I.M., Laser Cut or Display Letters
GI-32	1" Stud Length	0.79	Formed, I.M., Laser Cut or Display Letters
GI-33	1½" Stud Length	0.86	Formed, I.M., Laser Cut or Display Letters
GI-34	2" Stud Length	0.86	Formed, I.M., Laser Cut or Display Letters

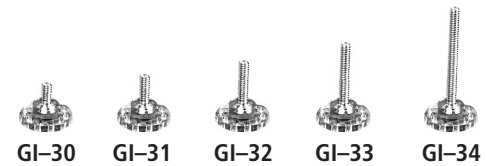

1" DIAMETER PAD WITH STUD

### Decorative Stand-Offs

EACH	UP TO 3/8" MATERIAL	1/2" - 7/8" MATERIAL	1" - 1-1/8" MATERIAL
1/2" DIAMETER 3/4" STANDOFF	\$8.90	\$9.30	\$9.80
1/2" DIAMETER 1-1/2" STANDOFF	11.20	11.90	12.40
1" DIAMETER 3/4" STANDOFF	13.00	13.70	14.30
1" DIAMETER 1-1/2" STANDOFF	16.60	17.60	18.50



½" diameter stand-offs: For use on smaller/lighter panels. #8 screw  
1" diameter stand-offs: For use on small or larger/heavier panels. #10 screw

## Adhesives

We have tested and approved Chem-Calc 1200 or GE RTV108 squeeze tubes of clear silicone, for installing lighter and smaller letters that are mounted with studs and/or pads. Otherwise, always test your adhesive for the installation situation – and use a quality silicone product.

Lighter and smaller parts can be installed with a quality silicone adhesive.

Heavier and larger letters and plaques should be installed with a “stronger” adhesive than Silicone. Always match your adhesive to the mounting surface and product weight. If in doubt, use a stronger industrial adhesive or epoxy – along with appropriate anchors and/or additional structural support.



ITEM	
10 OZ. Silicone caulking tube	\$40.70
2.8 OZ. Silicone squeeze tube	33.70

## Clear Acrylic Strips (Rails)

ITEM	ACRYLIC STRIPS
3/16" x 1-1/2" x 72"	\$36.69

Used for installing plastic letters. Glue (not silicone) letters to strips and install strips on wall. Good for irregular or corrugated surfaces. NOTE: Letters must be ordered “Pad for Rail”.

**Detachable Studs** - Includes a package of 6 with compatible allen wrench

ITEM	DETACHABLE STUDS
SMALL - 6-32 (1/8" diameter stud)	\$33.70
MEDIUM - 10-24 (3/16" diameter stud)	35.40
LARGE - 1/4-20 (1/4" diameter stud)	48.30



## Nuts (aluminum or stainless)

Available for:  
4-40, 6-32, 10-24 & 1/4-20 studs

ITEM	PRICE
3/16" Nuts	\$0.32

## Aluminum Spacers

Aluminum spacers are stocked in three sizes;

- Large - .275" I.D. (Inside Diameter) for 1/4-20 studs
- Small - .190" I.D. (Inside Diameter) for 10-24 studs
- Slim - .148" I.D. (Inside Diameter) for 6-32 and 4-40 studs; 1" max. length

## Studs\*

Aluminum Studs	1"	1.5"	2"	3"	4"	5"	6"
1/8" (6-32)	N/A	\$0.59	\$0.59	N/A	N/A	N/A	N/A
3/16" (10-24)	\$0.41	0.41	0.60	\$0.67	\$0.90	\$1.07	\$1.34
1/4" (1/4-20)	N/A	N/A	1.06	1.11	1.17	1.21	1.43

Stainless Steel Studs	5/8"	1"	1.5"	2"	3"	4"	5"	6"	8"
3/32" (4-40)	N/A	\$0.65	N/A	\$0.66	N/A	N/A	N/A	N/A	N/A
1/8" (6-32)	N/A	0.59	0.67	0.67	\$0.96	N/A	N/A	N/A	N/A
3/16" (10-24)	\$0.67	0.67	0.67	0.89	0.96	\$1.16	\$1.62	\$1.81	N/A
1/4" (1/4-20)	N/A	1.43	N/A	1.87	2.63	2.99	3.58	4.13	N/A
3/8" (3/8-16)	N/A	N/A	N/A	N/A	N/A	5.82	N/A	8.98	\$12.33

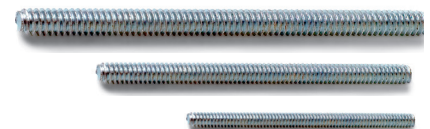

Special lengths in stainless steel studs may be available. Email for quote.

\* We reserve the right to limit order quantities

# PERFECT PATTERN™ - Flat Cut Metal, Flat Cut Acrylic & GemLeaf:

**Digitally precise, durably reliable, expanded application.** Gemini's digital technology now provides a better, more accurate tool for mounting flat-cut metal flat-cut acrylic and GemLeaf™ (coming soon for metal laminates). The mounting patterns are computer-generated and calibrated to production equipment, printed on Tyvek® to provide resistance to tears and the weather, and assure perfect alignment and exact drill hole locations. These exact hole locations are saved and easily replicated for replacement letters or repeat orders.

Improve your installation experience and ensure the look of each finished sign, with Perfect Pattern from Gemini — your guide to a perfect installation, every time.

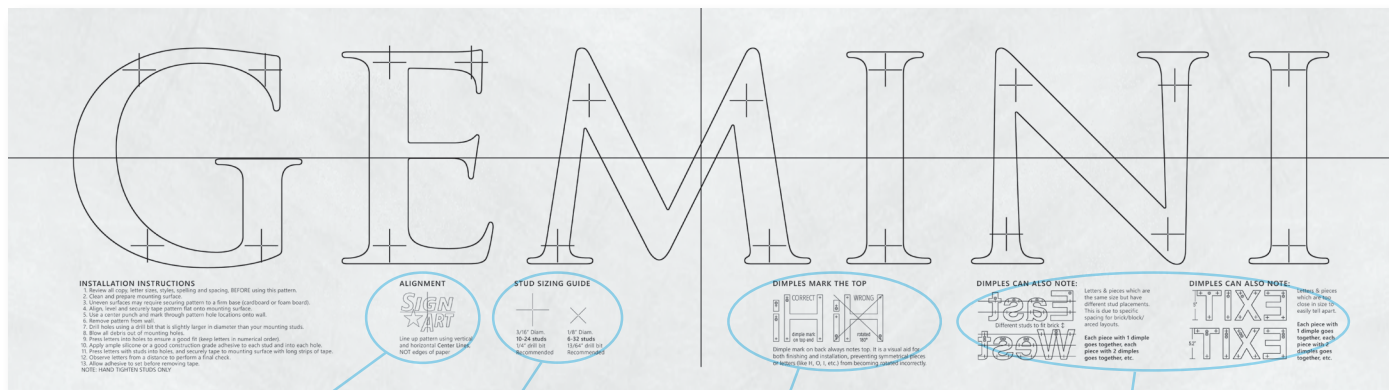

**Center Line Alignment**  
Patterns are aligned with horizontal and vertical lines from the center making installation more reliable.

**Stud Sizing Guide**  
The stud sizing guide provides recommendations for proper drill bits depending on determined stud size.

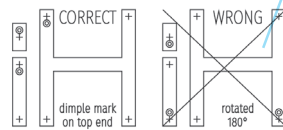

**Top/Bottom Orientation**  
Dimples are marked on the back to help identify proper orientation.

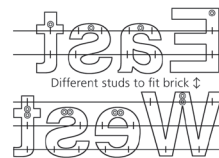

**Placement/Sizing Indicators**

Dimples can also indicate the line a character belongs to, as well as differentiate similar size letters which will have different stud placements.

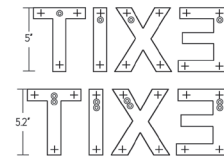

## Features and Benefits

- Precise drill locations marked, along with recommended drill bit size
- Identical letters are interchangeable
- Printed on weather-resistant Tyvek for no smudging, no tearing
- Printed legend with instructions
- Ability to produce and install replacement letters, with no extra drilling
- Ability to pre-order a pattern allowing pre-work for large scope installations



## Drawings & Guides

**DRILL PATTERN:** (for all other stud mounted products) Computer-generated tracing of letters with hand punched hole locations of studs, printed on 60# white grid paper. Once taped to wall, hole locations are then drilled and filled with adhesive.

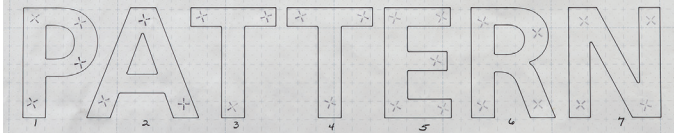

### NEW RIGID STENCIL GUIDES:

**Stencil** is a computer generated, full size cutout, designed for smaller letters, logos or bars. Typically used to install double face tape letters. Guide is taped to wall, letters are set inside cutout and adhered to wall. Gemini layout team will determine if Stencil or Split Stencil is best for your order.



**NEW Rigid Split Stencil** is a computer generated, partial cutout of bottom portion of the letters above the baseline, plus 2" below the baseline that provides a perfect way to install plain, pad or double face tape flat cut out letters. This split stencil is generated using the same file that we use to produce your letters. Gemini layout team will determine if Stencil or Split Stencil is best for your order.



### SPACING GUIDE:

A visual reference guide, typically used for pad mounted letters. The letters in a specific copy are spelled out and properly spaced on a long pattern table or computer generated. A narrow (approximately 2") piece of paper contains small hash marks or plotted lower portions of the letters. Guide is secured to the wall with tape, by the installer, and provides a visual guide for installing letters.



### LINE DRAWING:

An 8-1/2" x 11" drawing, showing the letter style and copy desired. A description of the style, size and material will be provided on the drawing. The drawing also gives an approximate line length.

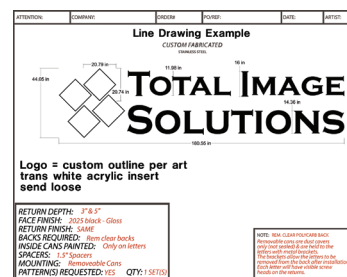

# Mounting Methods & Drawing / Guide Overview

Get the whole story on mounting. Talk to Gemini.

This chart is an overview of many popular mounting styles from Gemini. But for your challenging applications and technical questions, call or email our sales office. In addition, production drawings for over 70 different mounting styles, and numerous installation resources.

DRAWING / GUIDE ▼	AVAILABLE
Mounting Pattern	■
Stencil Guide	▲
Spacing Guide	●
Pounce Pattern	◆

PRODUCT TYPE ▼	Stud	Stud Brick/Block	Top Stud	Bottom Stud	Top & Bottom Stud	Rail/Top	Rail/Bottom	Rail/Single	Rail/Double	Bottom Angle Bracket
METAL	Cast	■	■	■	■	✓	✓	✓	✓	✓
	Flat Cut	■	■	■*	■*	✓	✓	✓	✓	✓
	Fabricated	■	■	■	■	✓	✓	✓	✓	✓
PLASTIC	Formed	■	■	n/a	n/a	n/a	n/a	✓	✓	n/a
	Injection Molded	■	■	n/a	n/a	n/a	n/a	✓	✓	n/a
	Laser Cut	■	■	■*	■*	■*	n/a	✓	✓	n/a
	Laminated	■	■	■*	■*	■*	n/a	✓	✓	n/a

✓ Mounting available but no drawing or guide available

\* Minimum 3/8" thick

PRODUCT TYPE ▼	Welded Stud	Engineered Stud	Detachable Stud	Plain	Pad	Combination	Combination All	Flange	Outside Bracket	Double-Faced Tape Mount
METAL	Cast	n/a	n/a	●	n/a	n/a	n/a	n/a	n/a	n/a
	Flat Cut	■	n/a	n/a	●	n/a	n/a	n/a	n/a	n/a
	Fabricated	n/a	■	■	●	n/a	n/a	n/a	n/a	n/a
PLASTIC	Formed	n/a	n/a	n/a	●	●	■	■	●	●
	Injection Molded	n/a	n/a	n/a	●	●	■	■	n/a	n/a
	Laser Cut	n/a	n/a	n/a	▲ ● ◆	●	■	■	n/a	n/a
	Laminated	n/a	n/a	n/a	▲ ● ◆	●	■	■	n/a	n/a

## Mounting Methods

Images for reference only. Some restrictions apply. See product sections for more information.

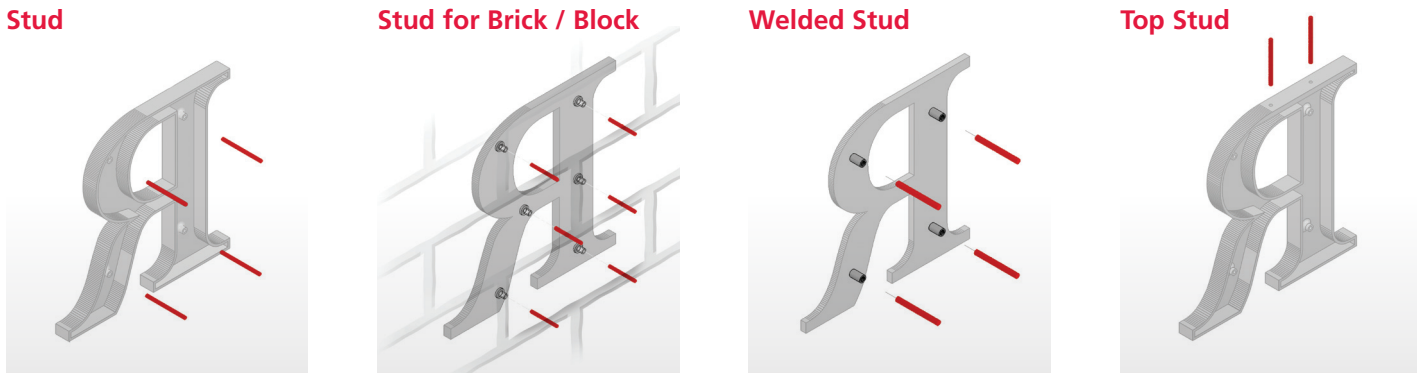

## Mounting Methods

Bottom Stud

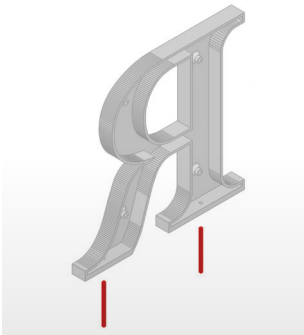

Top & Bottom Stud

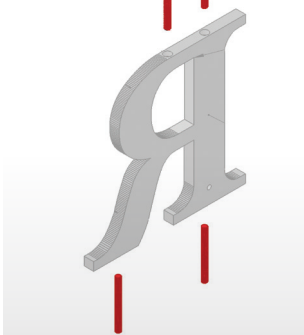

Engineered Stud

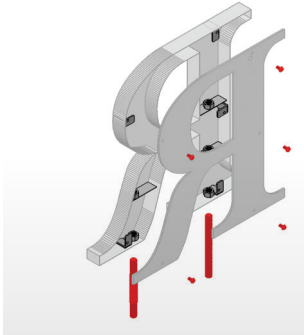

Rail / Top

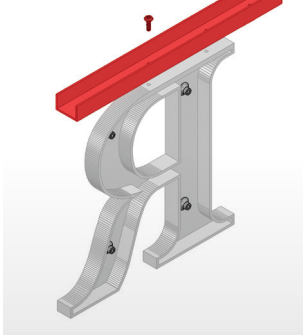

Rail / Bottom

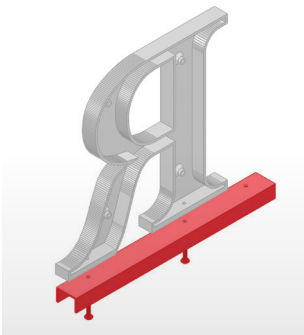

Rail / Single

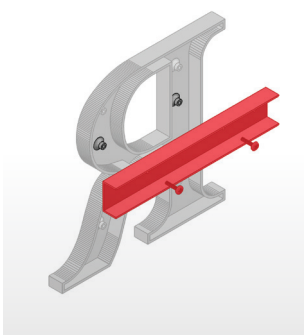

Rail / Double

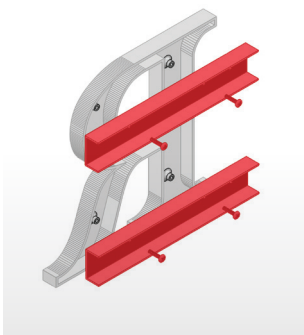

Bottom Angle Bracket

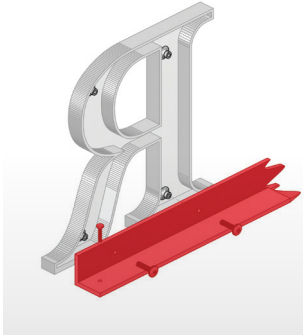

Combination

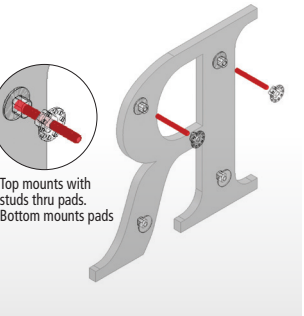

Combination All

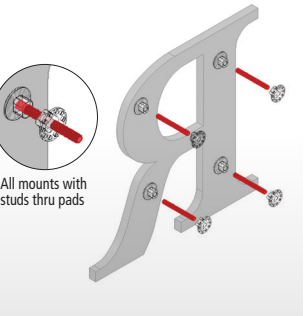

Pad

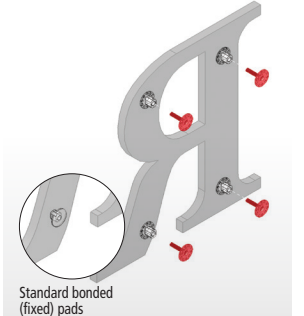

Detachable

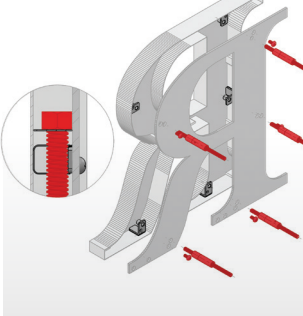

Formed Flange

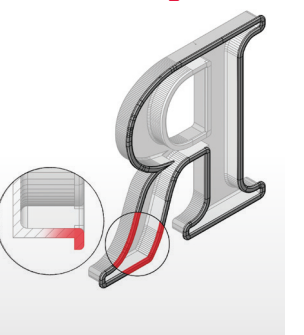

Bracket Mount

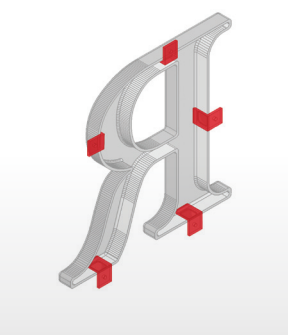

Double-Faced Tape

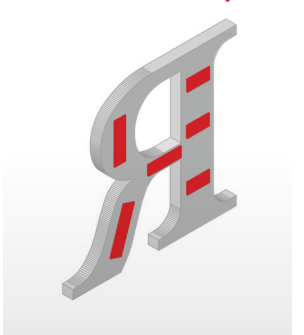

Plain









**USA LETTERS & LOGOS**  
**1-800-538-8377**

**Signage@GeminiMade.com**  
Monday–Friday: 7 a.m.–7 p.m.  
Saturday: 8 a.m.–noon (Central)  
International: 1-507-263-3957

**GEMINI INCORPORATED**

103 MENSING WAY

CANNON FALLS, MN 55009-1143 USA

1-800-538-8377

**www.GeminiSignage.com**



**GEMINI LETTERS, LOGOS & PLAQUES ARE GUARANTEED FOR LIFE.**

Our products are sold through Authorized Resellers.  
©2022 Gemini Incorporated